

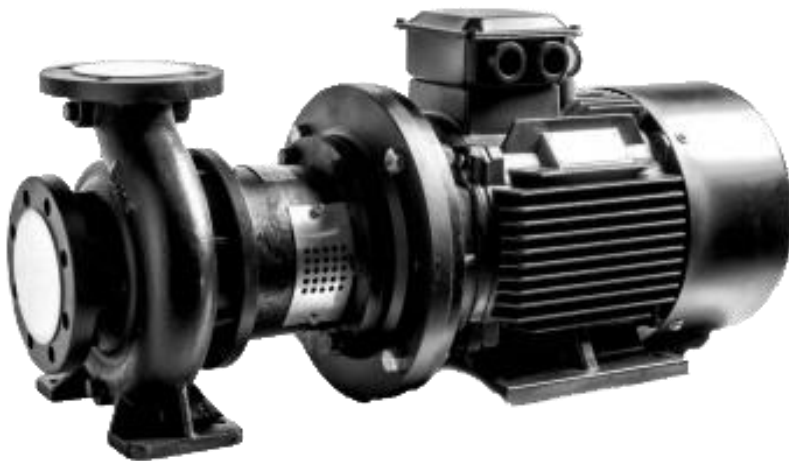

Centrifugal Pump



THIANTHONG INDUSTRY (THAILAND) CO.,LTD

Website:www.energyhealth2002.com

NES(O)

Versatility and reliability

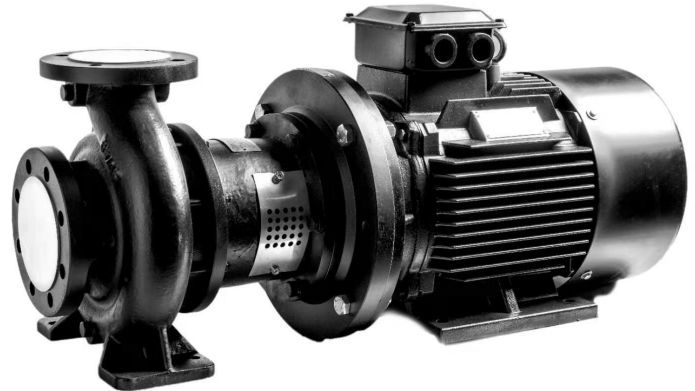

Automation products available:

- PumpExpert
- PumpDrive
- Hyamaster

Applications

- | | | | |
|-------------------------|-------------------|-------------------------|-----------------------|
| • General water supply | • Washing systems | • Irrigation | • Fuels |
| • Distillate | • Warm water | • Solvents | • Condensate |
| • Pressure boosting | • Reverse osmosis | • Heating | • Process |
| • Industry | • Hot water | • Fire-fighting systems | • Snow-making systems |
| • Drinking water supply | • Lubricants | • Boiler feed water | • Power plants |
| • Filter systems | • Circulation | | |

Design

Single-stage volute casing pump in back pull-out design with ratings to BS EN7331DIN 24255 and complying with the requirements of Directive 2009/125/EC, radially split volute casing with integrally cast pump feet, replaceable casing wear rings, Closed radial impeller with multiply curved vanes. Replaceable shaft sleeves/shaft protecting sleeves and casing wear rings. Pump can connect IEC or NEMA standard motor, it is widely used for North American market. ATEX-compliant version available.

Certification

ISO 9001

- Inlet Diameter: 50 ~ 300mm
- Out Diameter: 32 ~ 250mm
- Pump speed: 1180/1750/3500rpm
- Capacity: 6 ~ 1200m³/h
- Head: 4 ~ 140m
- Working pressure: 16bar, Up to 24 Bar(20°C)
- Liquid Temperature: -15°C ~ +110°C, -40°C ~ +150°C optional

Designation

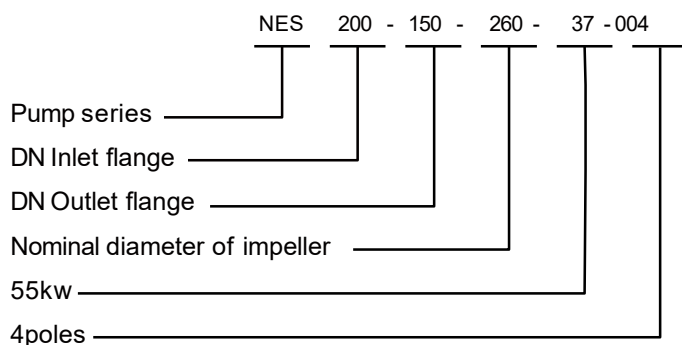

Drive

Electric motor 50 and 60 Hz; Diesel engine or turbine possible.

Material

Code	CI	CS	A7		A8		D1	
Material Classes and Abbreviation	CI / CI	CS / CS	304AUS / 304AUS		316AUS / 316AUS		Duplex / Duplex	
The Material Code of Pump Casing /Impeller	GG25 /GG20	CS / CS	304	304L	316	316L	14,460	CD4MCu
Code	CC	CS	A7	A7L	A8	A8L	D1	D1S
Casing	GG25	Carbon steel	CF-8	CF-3	CF-8M	CF-3M	14,460	CD4MCu
Back Cover	GG25	Carbon steel	CF-8	CF-3	CF-8M	CF-3M	14,460	CD4MCu
Impeller	GG20	Carbon steel	CF-8	CF-3	CF-8M	CF-3M	14,460	CD4MCu
Wear Ring	Cast iron	CF-3M					Duplex	Duplex
Shaft	SS420		CF-8	CF-3	CF-8M	CF-3M	1.446	
Shaft Sleeve for mechanical seal	GG20	Carbon steel	CF-8	CF-3	CF-8M	CF-3M	Duplex	Duplex
Shaft Sleeve for gland packing	GG20	Carbon steel	CF-8	CF-3	CF-8M	CF-3M		
Lantern Ring Packing Gland Cover	GG20	Carbon steel	CF-8	CF-3	CF-8M	CF-3M	Duplex	Duplex
Mech. Seal Cover	GG20	Carbon steel	CF-8	CF-3	CF-8M	CF-3M	Duplex	Duplex
Impeller Nut	CF-3M						Duplex	Duplex

Selection charts of NES (O) single stage centrifugal pump

n=1450rpm

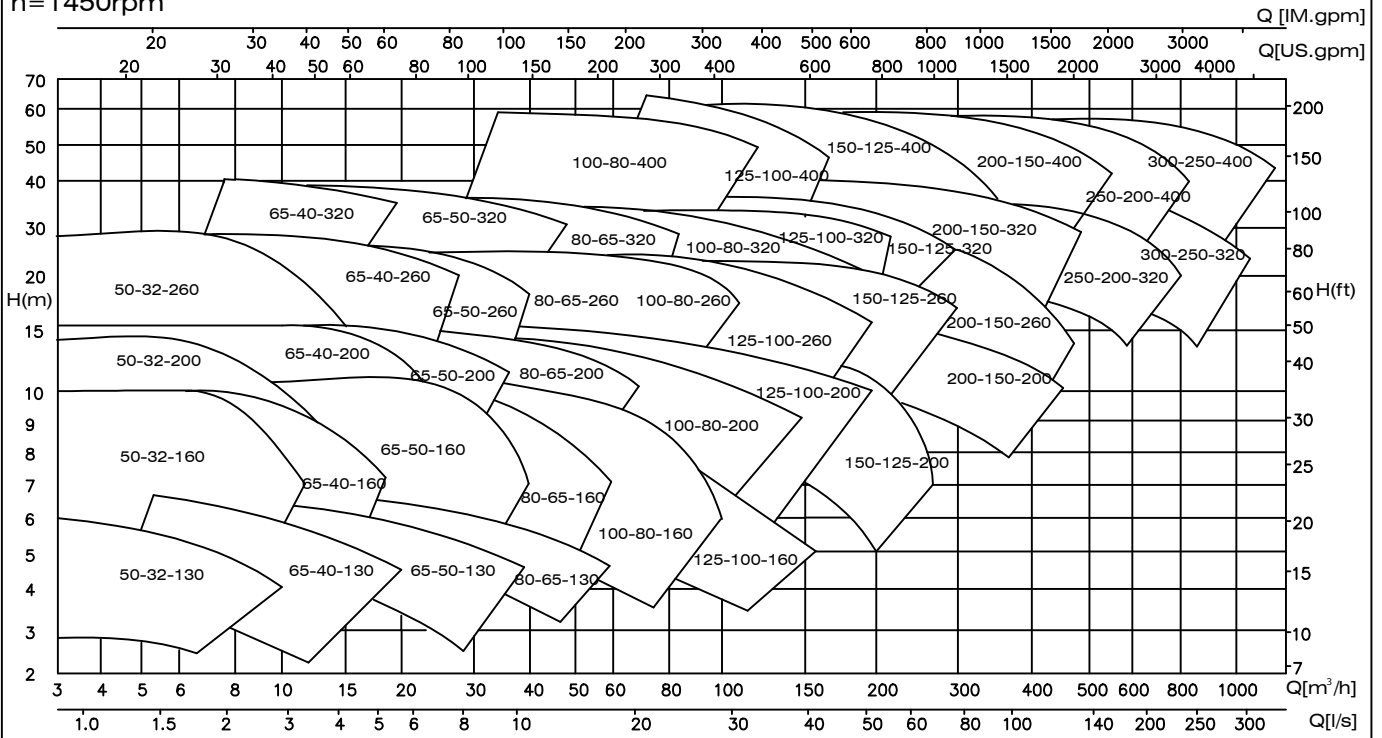

Selection charts of NES (O) single stage centrifugal pump

n=2900rpm

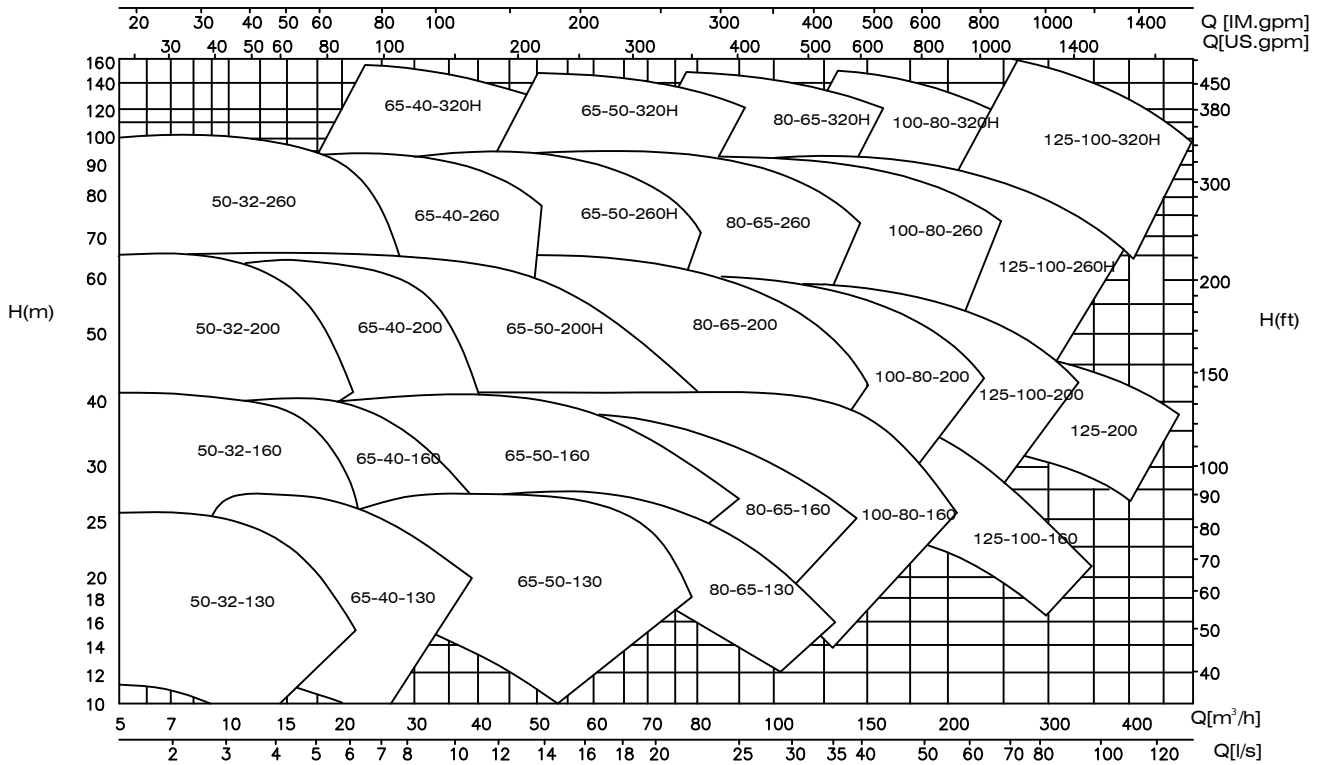

PERFORMANCE TABLE

NES(O) PUMP--50Hz

Type	CaNES(O)city (Q)		Head H	Speed n	Power		Mating motor	Eff	NPS HR	Impeller dia	Dia of Pump		Weight
	m ³ /h	L/s			m	r/min					Shaft Power	Motor Power	
			kw	kw			%	m	mm	mm	mm	kg	
NES(O) 50-32-130	9.0	2.5	24.5	2900	1.23	1.5	Y90L-2	49	1.8	139	50	32	27.5
	15.0	4.2	22.0		1.47	2.2	2.2KW	61	2				
	18.0	5.0	20.0		1.58	2.2		62	2.5				
NES(O) 50-32-130 A	8.5	2.4	21.2		1.04	1.5	Y90L-2	47	1.8	130			
	14.0	3.9	19.0		1.23	1.5	2.2KW	59	2				
	17.0	4.7	17.2		1.32	2.2		61	2.3				
NES(O) 50-32-130 B	7.8	2.2	18.0		0.89	1.1	Y90S-2	43	1.8	120			
	13.0	3.6	16.2		1.01	1.1	1.5KW	57	1.9				
	15.5	4.3	14.7		1.07	1.5		58	2.1				
NES(O) 50-32-130 C	7.2	2.0	15.1		0.72	1.1	Y8022	41	1.8	110			
	11.9	3.3	13.6		0.81	1.1	1.1KW	55	1.9				
	14.2	3.9	12.4		0.85	1.1		56	2.1				
NES(O) 50-32-130 D	6.5	1.8	12.5		0.57	0.75	Y8022	39	1.8	100			
	10.8	3.0	11.2		0.63	0.75	1.1KW	53	1.9				
	12.9	3.6	10.2		0.97	1.1		37	2.1				
NES(O) 50-32-160	11.0	3.1	40.0	2900	2.50	3	Y132S ₁ -2	48	1.9	174	50	32	35
	18.0	5.0	37.0		3.18	4	5.5KW	57	2				
	22.0	6.1	34.0		3.51	5.5		58	2.6				
NES(O) 50-32-160 A	10.5	2.9	35.7		2.22	3	Y112M-2	46	1.9	165			
	17.0	4.7	33.0		2.78	3	4KW	55	2				
	21.0	5.8	30.0		3.06	4		56	2.4				
NES(O) 50-32-160 B	9.8	2.7	31.4		1.93	2.2	Y112M-2	44	1.9	155			
	16.0	4.4	29.0		2.38	3	4KW	53	2				
	19.5	5.4	26.5		2.61	4		54	2.2				
NES(O) 50-32-160 C	9.2	2.5	27.5		1.65	2.2	Y100L-2	42	1.9	145			
	15.0	4.2	25.4		2.03	3	3KW	51	2				
	18.2	5.1	23.2		2.21	3		52	2.2				
NES(O) 50-32-160 D	8.5	2.4	22.0		1.28	2.2	Y90L-2	40	1.9	135			
	13.9	3.9	20.1		1.56	2.2	2.2KW	49	2				
	17.0	4.7	19.1		1.76	2.2		50	2.2				
NES(O) 50-32-160 E	7.9	2.2	18.9	1.03	1.1	Y90S-2	40	1.9	125				
	13.0	3.6	17.2	1.26	1.5	1.5KW	49	2					
	15.8	4.4	16.4	1.42	1.5		50	2.2					
NES(O) 50-32-200	11.0	3.1	63.0	2900	4.72	5.5	Y160M ₁ -	40	1.8	214	50	32	41
	18.0	5.0	59.0		5.90	7.5	11KW	49	2				
	22.0	6.1	55.5		6.52	11		51	2.3				
NES(O) 50-32-200 A	10.5	2.9	57.2		4.24	5.5	Y132S ₂ -2	39	1.8	205			
	17.0	4.7	54.0		5.26	7.5	7.5KW	48	2				
	21.0	5.8	50.2		5.80	7.5		50	2.2				
NES(O) 50-32-200 B	10.0	2.8	51.5		3.69	5.5	Y132S ₂ -2	38	1.8	195			
	16.5	4.6	48.0		4.61	7.5	7.5KW	47	1.9				
	20.0	5.6	45.0		5.02	7.5		49	2.2				

Type	CaNES(O)city (Q)		Head H	Speed n	Power		Mating motor	Eff	NPS HR	Impeller dia	Dia of Pump		Weight
	m ³ /h	L/s			m	r/min					Shaft Power kw	Motor Power kw	
								%	m	mm	mm	mm	mm
NES(O) 50-32-200 C	9.5	2.6	46.4	2900	3.24	4	Y132S ₁ -2	37	1.8	185	50	32	41
	15.7	4.3	43.2		4.02	5.5	5.5KW	46	1.9				
	19.0	5.3	40.5		4.38	5.5		48	2.2				
NES(O) 50-32-200 D	9.0	2.5	41.5		2.81	4	Y132S ₁ -2	36	1.8	175			
	14.8	4.1	38.7		3.46	5.5	5.5KW	45	1.9				
	17.9	5.0	36.2		3.77	5.5		47	2.2				
NES(O) 50-32-200 E	8.5	2.4	37.3		2.43	2.2	Y112M-2	36	1.8	165			
	14.0	3.9	34.8		2.99	4	4KW	45	1.9				
	17.0	4.7	32.6		3.25	4		47	2.2				
NES(O) 50-32-260	14.0	3.9	99.0	2900	11.26	15	Y160L-2	34	2.1	264	50	32	59
	22.0	6.1	95.0		13.23	15	18.5KW	43	2.2				
	26.0	7.2	92.0		14.47	18.5		45	2.6				
NES(O) 50-32-260 A	13.5	3.8	91.8		10.74	15	Y160M ₂ -	31	2.1	255			
	21.0	5.8	88.0		12.58	15	15KW	40	2.2				
	25.0	6.9	85.0		13.61	15		43	2.5				
NES(O) 50-32-260 B	13.0	3.6	84.5		9.97	15	Y160M ₂ -	30	2.2	245			
	20.5	5.7	81.0		11.74	15	15KW	39	2.2				
	24.0	6.7	78.4		12.62	15		41	2.4				
NES(O) 50-32-260 C	12.5	3.5	77.7		9.10	15	Y160M ₂ -	29	2.2	235			
	19.7	5.5	74.5		10.50	15	15KW	38	2.2				
	23.0	6.4	72.1		11.30	15		40	2.4				
NES(O) 50-32-260 D	11.9	3.3	71.3		8.27	11	Y160M ₂ -	28	2.2	225			
	18.8	5.2	68.3		9.46	15	15KW	37	2.2				
	22.0	6.1	66.1		10.17	15		39	2.4				
NES(O) 50-32-260 E	11.4	3.2	65.1		7.36	11	Y160M ₁ -	28	2.2	215			
	18.0	5.0	62.4		8.39	11	11KW	37	2.2				
	21.1	5.9	60.4		9.01	11		39	2.4				
NES(O) 65-40-130	18.0	5.0	25.5	2900	2.08	2.2	Y112M-2	60	1.8	139	65	40	30
	30.0	8.3	23.5		2.74	3	4KW	70	2				
	36.0	10.0	21.5		3.03	4		70	2.4				
NES(O) 65-40-130 A	16.8	4.7	22.0		1.80	2.2	Y112M-2	56	1.8	130			
	28.0	7.8	20.2		2.30	3	4KW	67	2				
	33.6	9.3	18.8		2.56	4		67	2.3				
NES(O) 65-40-130 B	15.5	4.3	18.5		1.47	1.5	Y100L-2	53	1.8	120			
	26.0	7.2	17.0		1.85	2.2	3KW	65	1.9				
	31.0	8.6	15.5		2.01	3		65	2.2				
NES(O) 65-40-130 C	14.2	3.9	15.5		1.18	1.5	Y90L-2	51	1.8	110			
	23.8	6.6	14.3		1.47	1.5	2.2KW	63	1.9				
	28.4	7.9	13.0		1.60	2.2		63	2.2				
NES(O) 65-40-130 D	12.9	3.6	12.8	0.90	1.5	Y90L-2	50	1.8	100				
	21.7	6.0	11.8	1.12	1.5	1.5KW	62	1.9					
	25.8	7.2	10.8	1.22	1.5		62	2.2					

Type	CaNES(O)city (Q)		Head H	Speed n	Power		Mating motor	Eff	NPS HR	Impeller dia	Dia of Pump		Weight
	m ³ /h	L/s			m	r/min					Shaft Power	Motor Power	
			kw	kw			mm	mm	kg				
NES(O) 65-40-160	18.0	5.0	39.5	2900	3.65	5.5	Y132S ₂ -2	53	2.1	174	65	40	36
	30.0	8.3	35.0		4.47	5.5	7.5KW	64	2.5				
	36.0	10.0	31.5		4.90	7.5		63	3.6				
NES(O) 65-40-160 A	17.0	4.7	34.8		3.16	4	Y132S ₁ -2	51	2.1	165	65	40	36
	28.5	7.9	30.5		3.82	5.5	5.5KW	62	2.5				
	34.0	9.4	27.6		4.19	5.5		61	3.3				
NES(O) 65-40-160 B	16.0	4.4	30.5		2.77	4	Y112M-2	48	2.1	155	65	40	36
	26.5	7.4	27.0		3.93	4	4KW	50	2.4				
	32.0	8.9	24.0		3.54	4		59	2.9				
NES(O) 65-40-160 C	15.0	4.2	26.7		2.31	3	Y112M-2	47	2.1	145	65	40	36
	24.8	6.9	23.6		3.29	4	4KW	49	2.4				
	29.9	8.3	21.0		2.95	4		58	2.9				
NES(O) 65-40-160 D	13.9	3.9	23.1		1.91	3	Y100L-2	46	2.1	135	65	40	36
	23.1	6.4	20.5		2.71	3	3KW	48	2.4				
	27.9	7.7	18.2		2.42	3		57	2.9				
NES(O) 65-40-160 E	12.9	3.6	19.8	1.53	3	Y100L-2	46	2.1	125	65	40	36	
	21.4	5.9	17.6	2.17	3	3KW	47	2.4					
	25.8	7.2	15.6	1.94	3		57	2.9					
NES(O) 65-40-200	18.0	5.0	63.0	2900	6.30	7.5	Y160M ₁ -	49	1.8	214	65	40	44
	30.0	8.3	58.0		8.17	11	11KW	58	2				
	36.0	10.0	53.0		8.96	11		58	2.7				
NES(O) 65-40-200 A	17.0	4.7	57.4		5.72	7.5	Y160M ₁ -	46	1.8	205	65	40	44
	29.0	8.1	52.4		7.45	11	11KW	56	2				
	34.5	9.6	48.0		8.05	11		56	2.5				
NES(O) 65-40-200 B	16.5	4.6	51.8		5.29	5.5	Y160M ₁ -	44	1.8	195	65	40	44
	27.5	7.6	47.5		6.71	7.5	11KW	53	1.9				
	33.0	9.2	43.3		7.23	11		54	2.2				
NES(O) 65-40-200 C	15.7	4.3	46.6		4.62	7.5	Y132S ₂ -2	43	1.8	185	65	40	44
	26.1	7.2	42.8		5.84	7.5	7.5KW	52	1.9				
	31.3	8.7	39.0		6.29	7.5		53	2.2				
NES(O) 65-40-200 D	14.8	4.1	41.7		4.00	5.5	Y132S ₂ -2	42	1.8	175	65	40	44
	24.7	6.9	38.3		5.04	7.5	7.5KW	51	1.9				
	29.6	8.2	34.9		5.43	7.5		52	2.2				
NES(O) 65-40-200 E	14.0	3.9	37.1	3.40	5.5	Y132S ₂ -2	42	1.8	165	65	40	44	
	23.3	6.5	34.0	4.27	7.5	7.5KW	51	1.9					
	27.9	7.8	31.0	4.59	7.5		51	2.2					
NES(O) 65-40-260	20.0	5.6	97.0	2900	13.20	15	Y180M ₁ -	40	1.8	264	65	40	61
	33.0	9.2	92.0		16.21	18.5	22KW	51	2.0				
	40.0	11.1	87.0		17.87	22		53	2.5				
NES(O) 65-40-260 A	19.5	5.4	89.0	12.27	15	Y160L-2	39	1.8	255	65	40	61	
	32.0	8.9	84.0	15.09	18.5	18.5KW	49	2					
	38.5	10.7	79.5	16.34	18.5		51	2.4					

Type	CaNES(O)city (Q)		Head H	Speed n	Power		Mating motor	Eff	NPS HR	Impeller dia	Dia of Pump		Weight
					Shaft Power	Motor Power					Inlet	Outle	
	m ³ /h	L/s	m	r/min	kw	kw	%	m	mm	mm	mm	kg	
NES(O) 65-40-260 B	18.5	5.1	82.0	2900	11.16	15	Y160L-2	37	1.8	245	65	40	61
	30.5	8.5	78.0		13.78	15	18.5KW	47	1.9				
	37.0	10.3	73.0		15.01	18.5		49	2.2				
NES(O) 65-40-260 C	17.7	4.9	75.4		10.12	15	Y160L-2	36	1.8	235			
	29.3	8.1	71.8		12.42	18.5	18.5KW	46	1.9				
	35.5	9.9	67.2		13.52	18.5		48	2.2				
NES(O) 65-40-260 D	17.0	4.7	69.2		9.14	11	Y160M ₂ -	35	1.8	225			
	28.0	7.8	65.8		11.15	15	15KW	45	1.9				
	34.0	9.4	61.6		12.12	15		47	2.2				
NES(O) 65-40-320G (NES(O) 65-40-320H)	21.6	6.0	155.0		28.04	30	Y225M-2	33	5.1	329			
	36.0	10.0	147.0		34.30	37	45KW	42	4.8				
	43.2	12.0	140.0		37.42	45		44	5.2				
NES(O) 65-40-320H A	20.5	5.7	137.0	24.66	30	Y200L ₂ -2	31	5.1	315				
	34.5	9.6	130.0	30.52	37	37KW	40	4.9					
	41.4	11.5	124.0	33.27	37		42	5					
NES(O) 65-40-320H B	19.8	5.5	122.0	22.29	30	Y200L ₂ -2	30	5.1	300				
	32.4	9.0	117.0	27.89	30	37KW	37	4.9					
	39.6	11.0	112.0	30.96	37		39	5					
NES(O) 65-40-320H C	18.7	5.2	110.0	20.36	22	Y200L ₁ -2	28	5.1	285				
	31.5	8.8	105.0	25.01	30	30KW	36	4.9					
	37.5	10.4	100.0	26.86	30		38	4.9					
NES(O) 65-40-320H D	17.5	4.9	95.0	18.10	22	Y200L ₁ -2	25	5.2	270				
	29.5	8.2	90.0	21.26	30	30KW	34	4.9					
	35.5	9.9	85.0	22.82	30		36	4.8					
NES(O) 65-40-320H E	16.7	4.7	85.0	16.10	18.5	Y180M-2	24	5.2	255				
	27.9	7.8	80.0	18.41	22	22KW	33	4.9					
	33.5	9.3	75.0	19.54	22		35	4.9					
NES(O) 65-50-130	36.0	10.0	25.5	3.84	5.5	Y132S ₂ -2	65	2.5	139				
	60.0	16.7	23.0	4.94	5.5	7.5KW	76	3.2					
	72.0	20.0	20.5	5.36	7.5		75	4					
NES(O) 65-50-130 A	33.5	9.3	22.0	3.18	4	Y132S ₁ -2	63	2.5	130				
	56.0	15.6	19.5	4.02	5.5	5.5KW	74	3.1					
	67.5	18.8	17.2	4.33	5.5		73	3.6					
NES(O) 65-50-130 B	31.0	8.6	18.5	2.56	3	Y132S ₁ -2	61	2.5	120				
	52.0	14.4	16.5	3.24	4	5.5KW	72	2.9					
	62.0	17.2	14.8	3.52	5.5		71	3.3					
NES(O) 65-50-130 C	28.4	7.9	15.5	2.00	3	Y112M-2	60	2.5	110				
	47.7	13.2	13.9	2.53	4	4KW	71	2.9					
	56.8	15.8	12.4	2.75	4		70	3.3					
NES(O) 65-50-160	40.0	11.1	41.5	7.06	11	Y160M ₁ -	64	2.5	174				
	65.0	18.1	38.0	9.09	11	11KW	74	3.5					
	78.0	21.7	35.0	10.04	11		74	4.2					

Type	CaNES(O)city (Q)		Head H	Speed n	Power		Mating motor	Eff	NPS HR	Impeller dia	Dia of Pump		Weight
					Shaft Power	Motor Power					Inlet	Outlet	
	m ³ /h	L/s	m	r/min	kw	kw	%	m	mm	mm	mm	kg	
NES(O)65-50-160 A	38.0	10.6	37.0	2900	6.17	7.5	Y160M ₁ - 11KW	62	2.5	165	65	50	38
	61.5	17.1	33.8		7.86	11	72	3.3					
	74.0	20.6	31.2		8.73	11	72	3.9					
NES(O)65-50-160 B	35.5	9.9	32.5		5.23	5.5	Y160M ₁ - 11KW	60	2.4	155			
	58.0	16.1	29.5		6.65	11	70	3.1					
	69.5	19.3	27.0		7.35	11	70	3.7					
NES(O)65-50-160 C	33.2	9.2	28.4		4.36	5.5	Y132S ₂ -2 7.5KW	59	2.4	145			
	54.3	15.1	25.8		5.53	7.5	69	3.1					
	65.0	18.1	23.6		6.11	7.5	69	3.7					
NES(O)65-50-160 D	30.9	8.6	24.7		3.58	5.5	Y132S ₂ -2 7.5KW	58	2.4	135			
	50.5	14.0	22.4		4.53	5.5	68	3.1					
	60.5	16.8	20.5		5.00	7.5	68	3.7					
NES(O)65-50-160 E	28.6	8.0	21.1		2.86	4	Y132S ₁ -2 5.5KW	58	2.4	125			
	46.8	13.0	19.2		3.62	5.5	68	3.1					
	56.0	15.6	17.6		4.00	5.5	67	3.7					
NES(O) 65-50-200	36.0	10.0	62.0	10.48	15	Y160L-2 18.5KW	58	2.5	214				
	60.0	16.7	56.0	13.07	15	70	3.2						
	72.0	20.0	50.0	14.41	18.5	68	4						
NES(O) 65-50-200 A	34.5	9.6	56.0	9.23	11	Y160M ₂ - 15KW	57	2.5	205				
	57.5	16.0	50.6	11.48	15	69	3.1						
	69.0	19.2	45.0	12.62	15	67	3.8						
NES(O) 65-50-200 B	33.0	9.1	50.6	8.19	11	Y160M ₂ - 15KW	56	2.5	195				
	54.5	15.1	45.6	10.02	15	68	3						
	65.5	18.2	40.5	10.94	15	66	3.5						
NES(O) 65-50-200 C	31.3	8.7	45.5	7.06	7.5	Y160M ₁ - 11KW	55	2.5	185				
	51.7	14.4	41.0	8.62	11	67	3						
	62.1	17.3	36.5	9.41	11	66	3.5						
NES(O) 65-50-200 D	29.7	8.3	38.5	5.71	7.5	Y160M ₁ - 11KW	55	2.5	175				
	49.1	13.6	34.7	7.07	7.5	66	3						
	59.0	16.4	30.8	7.60	11	65	3.5						
NES(O) 65-50-200 E	28.0	7.8	34.2	4.83	5.5	Y132S ₂ -2 7.5KW	54	2.5	165				
	46.3	12.8	30.8	5.97	7.5	65	3						
	55.6	15.4	27.4	6.42	7.5	65	3.5						
NES(O) 65-50-260H	40.0	11.1	100.0	20.16	30	Y200L ₂ -2 37KW	54	2.5	264				
	65.0	18.1	91.0	25.97	30	62	3.5						
	78.0	21.7	82.0	29.02	37	60	4.2						
NES(O) 65-50-260H A	38.5	10.7	92.5	18.29	22	Y200L ₁ -2 30KW	53	2.4	255				
	63.0	17.5	84.0	23.62	30	61	3.3						
	75.5	21.0	75.6	26.34	30	59	3.9						
NES(O) 65-50-260H B	37.0	10.3	85.5	16.56	18.5	Y200L ₁ -2 30KW	52	2.3	245				
	60.5	16.8	77.5	21.27	30	60	3.2						
	72.5	20.1	69.8	23.75	30	58	3.9						

Type	CaNES(O)city (Q)		Head H	Speed n	Power		Mating motor	Eff	NPS HR	Impeller dia	Dia of Pump		Weight
	m ³ /h	L/s			m	r/min					Shaft Power	Motor Power	
			kw	kw			%	m	kg				
NES(O) 65-50-260H C	35.5	9.9	78.7	2900	14.90	18.5	Y200L ₁ -2	51	2.3	235	65	50	63
	58.0	16.1	71.3		19.09	22	30KW	59	3.2				
	69.5	19.3	64.2		21.33	30		57	3.9				
NES(O) 65-50-260H D	34.0	9.4	72.1		13.33	15	Y180M-2	50	2.3	225			
	55.6	15.4	65.3		17.03	22	22KW	58	3.2				
	66.6	18.5	58.8		19.04	22		56	3.9				
NES(O) 65-50-260H E	32.5	9.0	65.8		11.75	15	Y160L-2	50	2.3	215			
	53.1	14.7	59.6		14.99	18.5	18.5KW	58	3.2				
	63.6	17.7	53.7		16.76	18.5		56	3.9				
NES(O) 65-50-320H	48.0	13.3	144.0	2900	40.46	45	Y280S-2	47	2.5	329	65	50	101
	80.0	22.2	133.0		50.81	55	75KW	57	3.7				
	96.0	26.7	124.0		55.87	75		58	3.1				
NES(O) 65-50-320H A	46.0	12.8	131.0		36.05	45	Y250M-2	46	2.5	315			
	76.5	21.3	120.0		44.63	55	55KW	56	3.7				
	92.0	25.6	112.0		49.21	55		57	3.3				
NES(O) 65-50-320H B	43.5	12.1	118.0		31.40	37	Y250M-2	45	2.4	300			
	73.0	20.3	109.0		39.38	45	55KW	55	3.6				
	87.5	24.3	103.0		43.81	55		56	3.5				
NES(O) 65-50-320H C	41.4	11.5	107.0		27.41	30	Y225M-2	44	2.3	285			
	69.0	19.2	98.0		34.09	37	45KW	54	3.5				
	82.8	23.0	92.0		37.70	45		55	3.7				
NES(O) 65-50-320H D	39.0	10.8	92.0		22.71	30	Y200L ₂ -2	43	2.2	270			
	65.5	18.2	86.0		28.93	37	37KW	53	3.3				
	77.4	21.5	80.0		31.21	37		54	3.7				
NES(O) 65-50-320H E	37.0	10.3	82.0		19.66	22	Y200L ₁ -2	42	2.1	255			
	62.0	17.2	75.0		24.34	30	30KW	52	3.1				
	74.5	20.7	70.0		26.79	30		53	3.6				
NES(O) 80-65-130	60.0	16.7	25.0	2900	6.09	7.5	Y160M ₁ -1	67	3	139	80	65	39
	100.0	27.8	22.0		7.68	11	11KW	78	3.5				
	120.0	33.3	19.0		8.39	11		74	4.5				
NES(O) 80-65-130 A	56.0	15.6	21.5		5.04	7.5	Y160M ₁ -1	65	3	130			
	93.5	26.0	18.5		6.20	11	11KW	76	3.5				
	112.5	31.3	16.0		6.81	11		72	4.1				
NES(O) 80-65-130 B	52.0	14.4	18.0		4.04	5.5	Y132S ₂ -2	63	3	120			
	86.5	24.0	15.5		4.93	7.5	7.5KW	74	3.3				
	104.0	28.9	13.0		5.26	7.5		70	3.8				
NES(O) 80-65-160	60.0	16.7	39.0	2900	10.27	15	Y160L-2	62	3.6	174	80	65	43
	100.0	27.8	35.0		12.70	15	18.5KW	75	4.2				
	120.0	33.3	32.0		13.94	18.5		75	5.2				
NES(O) 80-65-160 A	57.0	15.8	34.5		8.92	11	Y160M ₂ -2	60	3.6	165			
	95.0	26.4	31.0		10.98	15	15KW	73	4.1				
	114.0	31.7	28.0		11.90	15		73	4.8				

Type	CaNES(O)city (Q)		Head H	Speed n	Power		Mating motor	Eff	NPS HR	Impeller dia	Dia of Pump		Weight
					Shaft Power	Motor Power					Inlet	Outlet	
	m ³ /h	L/s	m	r/min	kw	kw	%	m	mm	mm	mm	kg	
NES(O) 80-65-160 B	53.5	14.9	30.0	2900	7.53	11	Y160M ₁ - 11KW	58	3.6	155	80	65	43
	89.0	24.7	27.0		9.21	11		71	4				
	107.0	29.7	24.5		10.05	11		71	4.5				
NES(O) 80-65-160 C	50.0	13.9	26.3		6.28	11	Y160M ₁ - 11KW	57	3.6	145			
	83.3	23.1	23.6		7.65	11		70	4				
	100.1	27.8	21.4		8.35	11		70	4.5				
NES(O) 80-65-160 D	46.6	12.9	22.8		5.15	7.5	Y160M ₁ - 11KW	56	3.6	135			
	77.5	21.5	20.5		6.26	11		69	4				
	93.2	25.9	18.6		6.83	11		69	4.5				
NES(O) 80-65-160 E	43.1	12.0	19.5		4.13	5.5	Y132S ₂ -2 7.5KW	56	3.6	125			
	71.8	19.9	17.6		5.01	7.5		69	4				
	86.3	24.0	15.9		5.46	7.5		69	4.5				
NES(O) 80-65-200H	66.0	18.3	63.0		17.97	22	Y200L ₁ -2 30KW	63	3	214			
	110.0	30.6	57.0		23.07	30		74	3.9				
	132.0	36.7	52.0		25.08	30		75	5.3				
NES(O) 80-65-200H A	63.0	17.5	57.0	15.77	18.5	Y200L ₁ -2 30KW	62	3	205				
	105.5	29.3	51.0	20.06	30		73	3.8					
	126.5	35.1	47.0	22.02	30		74	4.9					
NES(O) 80-65-200H B	60.0	16.7	51.5	13.79	18.5	Y200L ₁ -2 30KW	61	3	195				
	100.0	27.8	46.5	17.58	22		72	3.6					
	120.0	33.3	42.5	19.15	30		73	4.4					
NES(O) 80-65-200H C	56.9	15.8	46.4	11.97	15	Y180M-2 22KW	60	3	185				
	94.9	26.4	41.9	15.22	22		71	3.6					
	113.8	31.6	38.3	16.58	22		72	4.4					
NES(O) 80-65-200H D	53.8	15.0	41.5	10.30	15	Y160L-2 18.5KW	59	3	175				
	89.7	24.9	37.4	13.07	18.5		70	3.6					
	107.7	29.9	34.2	14.23	18.5		71	4.4					
NES(O) 80-65-200H E	50.8	14.1	36.9	8.71	11	Y160M ₂ - 15KW	59	3	165				
	84.6	23.5	33.3	11.03	15		70	3.6					
	101.5	28.2	30.4	12.01	15		70	4.4					
NES(O) 80-65-260	72.0	20.0	97.0	32.78	37	Y250M-2 55KW	58	3.3	264				
	120.0	33.3	89.0	39.83	45		73	4.5					
	144.0	40.0	83.0	44.57	55		73	5.4					
NES(O) 80-65-260 A	69.5	19.3	90.0	26.20	37	Y225M-2 45KW	65	3.3	255				
	116.0	32.2	82.5	36.18	45		72	4.4					
	139.0	38.6	77.0	40.47	45		72	5					
NES(O) 80-65-260 B	67.0	18.6	83.0	23.65	30	Y225M-2 45KW	64	3.2	245				
	111.5	31.0	76.0	32.49	37		71	4.3					
	133.5	37.1	71.0	36.60	45		71	5					
NES(O) 80-65-260 C	64.3	17.9	76.4	21.20	30	Y200L ₂ -2 37KW	63	3.2	235				
	106.9	29.7	69.9	29.08	37		70	4.3					
	128.1	35.6	65.3	33.00	37		69	5					

Type	CaNES(O)city (Q)		Head H	Speed n	Power		Mating motor	Eff	NPS HR	Impeller dia	Dia of Pump		Weight
					Shaft Power	Motor Power					Inlet	Outle	
	m ³ /h	L/s	m	r/min	kw	kw	%	m	mm	mm	mm	kg	
NES(O) 80-65-260 D	61.5	17.1	70.0	2900	18.91	22	Y200L ₂ -2 37KW	62	3.2	225	80	65	81
	102.4	28.4	64.1		25.89	30		69	4.3				
	122.6	34.1	59.9		29.39	37		68	5				
NES(O) 80-65-260 E	58.8	16.3	63.9	2900	16.63	18.5	Y200L ₁ -2 30KW	62	3.2	215	80	65	81
	97.8	27.2	58.5		22.76	30		69	4.3				
	117.2	32.5	54.7		25.83	30		68	5				
NES(O) 80-65-320H	78.0	21.7	147.0	2900	57.80	75	Y280M-2 90KW	54	2.2	329	80	65	110
	130.0	36.1	132.0		74.74	90		63	2.4				
	156.0	43.3	115.0		81.39	90		60	3.2				
NES(O) 80-65-320H A	74.5	20.7	132.0	2900	50.04	55	Y280M-2 90KW	54	2.2	315	80	65	110
	124.0	34.4	118.0		65.30	75		61	2.3				
	149.0	41.4	102.0		71.33	90		58	3				
NES(O) 80-65-320H B	71.0	19.7	118.0	2900	43.03	55	Y280S-2 75KW	53	2.2	300	80	65	110
	119.0	33.0	102.0		56.00	75		59	2.2				
	142.0	39.4	88.0		61.29	75		56	2.7				
NES(O) 80-65-320H C	67.5	18.8	105.0	2900	37.10	45	Y280S-2 75KW	52	2.2	285	80	65	110
	113.0	31.4	93.0		48.90	55		59	2.2				
	135.0	37.5	79.0		53.27	75		55	2.5				
NES(O) 80-65-320H D	64.0	17.8	94.0	2900	32.11	37	Y250M-2 55KW	51	2.2	270	80	65	110
	107.0	29.7	82.0		41.18	55		58	2.2				
	128.0	35.6	70.0		45.59	55		54	2.4				
NES(O) 80-65-320H E	60.0	16.7	82.0	2900	26.79	30	Y225M-2 45KW	50	2.2	255	80	65	110
	100.0	27.8	72.0		34.39	37		57	2.2				
	120.0	33.3	61.0		38.32	45		52	2.3				
NES(O) 100-80-160	100.0	27.8	39.0	2900	15.85	18.5	Y200L ₁ -2 30KW	67	3.3	174	100	80	54
	162.0	45.0	35.0		19.29	22		80	4				
	195.0	54.2	31.5		21.17	30		79	5				
NES(O) 100-80-160 A	95.0	26.4	34.5	2900	13.73	18.5	Y180M-2 22KW	65	3.3	165	100	80	54
	153.5	42.6	31.0		16.61	18.5		78	3.9				
	185.0	51.4	28.0		18.31	22		77	4.6				
NES(O) 100-80-160 B	89.0	24.7	30.5	2900	11.73	15	Y160L-2 18.5KW	63	3.3	155	100	80	54
	144.5	40.1	27.2		14.08	15		76	3.7				
	174.0	48.3	24.5		15.47	18.5		75	4.3				
NES(O) 100-80-160 C	83.3	23.1	26.7	2900	9.76	11	Y160M ₂ - 15KW	62	3.3	145	100	80	54
	135.2	37.5	23.8		11.68	15		75	3.7				
	162.8	45.2	21.4		12.84	15		74	4.3				
NES(O) 100-80-160 D	77.5	21.5	23.1	2900	7.94	11	Y160M ₂ - 15KW	62	3.3	135	100	80	54
	125.9	35.0	20.6		9.49	15		75	3.7				
	151.5	42.1	18.6		10.43	15		74	4.3				
NES(O) 100-80-200	115.0	31.9	61.0	2900	27.28	37	Y225M-2 45KW	70	4	214	100	80	70
	190.0	52.8	55.0		35.56	37		80	5.1				
	225.0	62.5	50.0		38.77	45		79	6.2				

Type	CaNES(O)city (Q)		Head H	Speed n	Power		Mating motor	Eff	NPS HR	Impeller dia	Dia of Pump		Weight
					Shaft Power	Motor Power					Inlet	Outlet	
	m ³ /h	L/s	m	r/min	kw	kw	%	m	mm	mm	mm	kg	
NES(O) 100-80-200 A	110.0	30.6	55.5	2900	24.09	30	Y200L ₂ -2 37KW	69	4	205	100	80	70
	182.0	50.6	50.0		31.36	37		79	4.9				
	215.5	59.9	45.5		34.22	37		78	5.9				
NES(O) 100-80-200 B	105.0	29.2	50.0		21.02	30	Y200L ₂ -2 37KW	68	4	195			
	173.0	48.1	45.0		27.17	30		78	4.7				
	205.0	56.9	41.0		29.71	37		77	5.5				
NES(O) 100-80-200 C	99.6	27.7	45.0		18.21	22	Y200L ₁ -2 30KW	67	4	185			
	164.1	45.6	40.5		23.50	30		77	4.7				
	194.5	54.0	36.9		25.71	30		76	5.5				
NES(O) 100-80-200 D	94.2	26.2	40.3		15.65	18.5	Y200L ₁ -2 30KW	66	4	175			
	155.3	43.1	36.2		20.15	30		76	4.7				
	184.0	51.1	33.0		22.05	30		75	5.5				
NES(O) 100-80-200 E	88.8	24.7	35.8		13.22	15	Y180M-2 22KW	66	4	165			
	146.4	40.7	32.2		17.00	22		76	4.7				
	173.5	48.2	29.4		18.60	22		75	5.5				
NES(O) 100-80-260	115.0	31.9	96.0	45.54	55	Y280S-2 75KW	66	4	264				
	190.0	52.8	86.0	57.77	75		77	5.4					
	225.0	62.5	79.0	64.52	75		75	6.5					
NES(O) 100-80-260 A	111.0	30.8	89.0	41.37	55	Y280S-2 75KW	65	4	255				
	183.5	51.0	79.8	52.45	75		76	5.2					
	217.5	60.4	73.0	58.41	75		74	6.3					
NES(O) 100-80-260 B	106.5	29.6	82.0	37.15	45	Y280S-2 75KW	64	3.9	245				
	176.5	49.0	73.5	47.09	55		75	5					
	209.0	58.1	67.5	52.61	75		73	6					
NES(O) 100-80-260 C	102.2	28.4	75.4	33.30	45	Y250M-2 55KW	63	3.9	235				
	169.3	47.0	67.6	42.11	55		74	5					
	200.5	55.7	62.1	47.07	55		72	6					
NES(O) 100-80-260 D	97.8	27.2	69.2	29.70	37	Y250M-2 55KW	62	3.9	225				
	162.1	45.0	62.0	37.47	45		73	5					
	191.9	53.3	56.9	41.31	55		72	6					
NES(O) 100-80-260 E	93.5	26.0	63.1	26.12	37	Y225M-2 45KW	62	3.9	215				
	154.9	43.0	56.6	32.92	37		73	5					
	183.4	50.9	52.0	36.30	45		72	6					
NES(O) 100-80-320H	120.0	33.3	142.0	76.04	90	Y315M ₁ - 132KW	61	3.1	329				
	200.0	55.6	127.0	101.68	132		68	3.4					
	240.0	66.7	110.0	112.29	132		64	3.7					
NES(O) 100-80-320H A	115.0	32.0	130.0	67.83	75	Y315S-2 110KW	60	3.1	315				
	191.0	53.0	116.0	90.02	110		67	3.3					
	230.0	63.9	100.0	99.38	110		63	3.6					
NES(O) 100-80-320H B	110.0	30.6	118.0	59.89	75	Y315S-2 110KW	59	3.1	300				
	182.0	50.6	103.0	77.91	90		66	3.2					
	220.0	61.1	89.0	86.67	110		62	3.5					

Type	CaNES(O)city (Q)		Head H	Speed n	Power		Mating motor	Eff	NPS HR	Impeller dia	Dia of Pump		Weight								
					Shaft Power	Motor Power					Inlet	Outle									
	m ³ /h	L/s	m	r/min	kw	kw	%	m	mm	mm	mm	kg									
NES(O) 100-80-320H C	104.0	28.9	106.0	2900	51.74	75	Y280M-2	58	3	285	100	80	120								
	173.0	48.0	92.0		67.17	75	90KW	65	3.2												
	208.0	57.8	79.0		74.55	90		60	3.4												
NES(O) 100-80-320H D	98.5	27.4	94.0		2900	44.22	55	Y280S-2	57	2.9				270	100	80	120				
	164.0	45.6	82.0			57.65	75	75KW	64	3.2											
	197.0	54.7	70.0			64.72	75		58	3.3											
NES(O) 100-80-320H E	93.0	25.8	84.0			2900	37.98	45	Y280S-2	56				2.9				255	100	80	120
	155.0	43.1	70.0				47.64	55	75KW	62				3.1							
	186.0	51.7	60.0				54.25	75		56				3.2							
NES(O) 125-100-160	165.0	45.8	37.5	2900			24.06	30	Y200L ₁ -2	70	5	190	125	100				71			
	200.0	55.6	34.0				25.71	30	30KW	72	5										
	270.0	75.0	22.5				27.56	30		60	5.5										
NES(O) 125-100-160 A	156.3	43.4	33.7		2900		20.62	22	Y200L ₁ -2	70	4.9	180			125	100	71				
	189.5	52.6	30.5				22.03	30	30KW	72	4.9										
	255.8	71.1	20.2				23.65	30		60	5.4										
NES(O) 125-100-160 B	139.9	38.9	27.0			2900	14.88	18.5	Y180M-2	69	4.8	170							125	100	71
	169.5	47.1	24.4				15.89	18.5	22KW	71	4.8										
	228.9	63.6	16.2				17.08	22		59	5.3										
NES(O) 125-100-160 C	117.8	32.7	19.1	2900			8.95	15	Y160L-2	69	4.7	160	125	100				71			
	142.8	39.7	17.3				9.55	15	18.5KW	71	4.7										
	192.7	53.5	11.5				10.29	18.5		59	5.2										
NES(O) 125-100-200	180.0	50.0	59.0		2900		41.30	55	Y280S-2	70	4	214			125	100	85				
	285.0	79.2	52.0				50.12	75	75KW	81	5.3										
	340.0	94.4	44.0				54.66	75		75	6.3										
NES(O) 125-100-200 A	172.5	47.9	52.5			2900	35.73	45	Y250M-2	69	4	205							125	100	85
	273.0	75.8	46.0				43.00	55	55KW	80	4.9										
	325.5	90.4	38.0				45.81	55		74	6										
NES(O) 125-100-200 B	164.0	45.6	47.0	2900			30.86	37	Y225M-2	68	3.9	195	125	100				85			
	260.0	72.2	40.0				36.07	45	45KW	79	4.8										
	310.0	86.1	32.5				37.83	45		73	5.6										
NES(O) 125-100-200 C	155.6	43.2	42.3		2900		26.74	37	Y200L ₂ -2	67	3.9	185			125	100	85				
	246.7	68.5	36.0				31.39	37	37KW	77	4.8										
	294.1	81.7	29.3				32.75	37		72	5.6										
NES(O) 125-100-200 D	147.2	40.9	37.9			2900	22.98	30	Y200L ₁ -2	66	3.9	175							125	100	85
	233.3	64.8	32.2				26.92	30	30KW	76	4.8										
	278.2	77.3	26.2				28.12	30		71	5.6										
NES(O) 125-100-200 E	138.8	38.5	33.6	2900			19.41	30	Y200L ₁ -2	66	3.9	165	125	100				85			
	220.0	61.1	28.6				22.72	30	30KW	76	4.8										
	262.3	72.9	23.3				23.73	30		70	5.6										
NES(O) 125-100-260	190.0	52.8	97.0		2900		71.67	90	Y315S-2	70	3.8	264			125	100	115				
	295.0	81.9	85.0				87.51	100	110KW	78	5.2										
	350.0	97.2	75.0				97.89	110		73	6.5										

Type	CaNES(O)city (Q)		Head H	Speed n	Power		Mating motor	Eff	NPS HR	Impeller dia	Dia of Pump		Weight
					Shaft Power	Motor Power					Inlet	Outle	
	m ³ /h	L/s	m	r/min	kw	kw	%	m	mm	mm	mm	kg	
NES(O) 125-100-260 A	183.5	51.0	89.0	2900	64.43	75	Y315S-2	69	3.8	255	125	100	115
	285.0	79.2	78.0		78.59	90	110KW	77	5				
	338.0	93.9	68.5		87.54	100		72	6.2				
NES(O) 125-100-260 B	177.0	49.2	82.0	2900	58.10	75	Y280M-2	68	3.7	245	125	100	115
	274.0	76.1	71.5		70.17	90	90KW	76	4.8				
	325.0	90.3	63.0		78.50	90		71	5.9				
NES(O) 125-100-260 C	169.8	47.2	75.4	2900	52.04	75	Y280S-2	67	3.7	235	125	100	115
	262.8	73.0	65.8		62.75	75	75KW	75	4.8				
	311.7	86.6	58.0		70.27	75		70	5.9				
NES(O) 125-100-260 D	162.6	45.2	69.2	2900	46.37	55	Y280S-2	66	3.7	225	125	100	115
	251.6	69.9	60.3		55.82	75	75KW	74	4.8				
	298.5	82.9	53.1		62.56	75		69	5.9				
NES(O) 125-100-260 E	155.3	43.1	63.1	2900	40.76	55	Y280S-2	66	3.7	215	125	100	115
	240.4	66.8	55.1		49.03	75	75KW	74	4.8				
	285.2	79.2	48.5		54.99	75		69	5.9				
NES(O) 150-125-200	238.0	66.0	54.5	2900	59.34	75	Y280M-2	60	7	214	150	125	106
	360.0	100.0	49.0		66.23	90	90KW	73	7.2				
	475.0	132.0	40.0		70.85	90		73	7				
NES(O) 150-125-200 A	228.0	63.2	49.5	2900	52.52	75	Y280S-2	59	7	205	150	125	106
	345.0	95.8	44.0		57.79	75	75KW	72	7.1				
	455.0	126.0	35.3		60.73	75		72	6.9				
NES(O) 150-125-200 B	216.0	60.1	44.8	2900	45.81	55	Y280S-2	58	7	195	150	125	106
	328.0	91.1	39.5		50.03	55	75KW	71	7				
	433.0	120.0	31.5		52.30	75		71	6.6				
NES(O) 150-125-200 C	205.3	57.0	40.3	2900	40.23	55	Y225M-2	56	7	185	150	125	106
	311.1	86.4	35.6		43.02	55	45KW	70	6.5				
	409.8	113.8	28.4		44.87	55		71	6.4				

Type	CaNES(O)city (Q)		Head H	Speed n	Power		Mating motor	Eff	NPS HR	Impeller dia	Dia of Pump		Weight
	m ³ /h	L/s			m	r/min					Shaft Power kw	Motor Power kw	
							%	m	mm				
NES(O) 50-32-130	4.5	1.3	6.0	1450	0.16	0.55	Y801-4	47	1.8	139	50	32	27.5
	7.5	2.1	5.5		0.20	0.55	0.55KW	57	2				
	9.0	2.5	5.0		0.21	0.55		58	2.3				
NES(O) 50-32-130 A	4.2	1.2	5.2		0.13	0.55	Y801-4	47	1.8	130			
	7.0	1.9	4.8		0.16	0.55	0.55KW	57	2				
	8.4	2.3	4.4		0.17	0.55		58	2.3				
NES(O) 50-32-130 B	3.9	1.1	4.5		0.10	0.55	Y801-4	46	1.8	120			
	6.5	1.8	4.1		0.13	0.55	0.55KW	56	2				
	7.8	2.2	3.7		0.14	0.55		57	2.3				
NES(O) 50-32-130 C	3.6	1.0	3.8		0.08	0.55	Y801-4	46	1.8	110			
	5.9	1.6	3.4		0.10	0.55	0.55KW	56	2				
	7.1	2.0	3.1		0.11	0.55		57	2.3				
NES(O) 50-32-130 D	3.2	0.9	3.1		0.06	0.55	Y801-4	45	1.8	100			
	5.4	1.5	2.8		0.08	0.55	0.55KW	55	2				
	6.5	1.8	2.6		0.08	0.55		56	2.3				
NES(O) 50-32-160	6.0	1.7	9.5	0.35	0.55	Y801-4	44	1.8	174				
	9.0	2.5	9.0	0.42	0.55	0.55KW	53	2					
	11.0	3.1	8.3	0.46	0.55		54	2.4					
NES(O) 50-32-160 A	5.7	1.6	8.5	0.30	0.55	Y801-4	44	1.8	165				
	8.5	2.4	8.1	0.36	0.55	0.55KW	53	2					
	10.4	2.9	7.5	0.40	0.55		54	2.4					
NES(O) 50-32-160 B	5.4	1.5	7.5	0.26	0.55	Y801-4	43	1.8	155				
	8.0	2.2	7.1	0.30	0.55	0.55KW	52	2					
	9.8	2.7	6.6	0.33	0.55		53	2.4					
NES(O) 50-32-160 C	5.0	1.4	6.6	0.21	0.55	Y801-4	43	1.8	145				
	7.5	2.1	6.3	0.25	0.55	0.55KW	52	2					
	9.2	2.5	5.8	0.27	0.55		53	2.4					
NES(O) 50-32-160 D	4.7	1.3	5.7	0.17	0.55	Y801-4	42	1.8	135				
	7.0	1.9	5.4	0.20	0.55	0.55KW	51	2					
	8.5	2.4	5.0	0.22	0.55		52	2.4					
NES(O) 50-32-160 E	4.3	1.2	4.9	0.14	0.55	Y801-4	42	1.8	125				
	6.5	1.8	4.6	0.16	0.55	0.55KW	51	2					
	7.9	2.2	4.3	0.18	0.55		52	2.4					
NES(O) 50-32-200	6.0	1.7	15.0	0.64	0.75	Y90S-4	38	1.8	214				
	9.0	14.0	14.0	0.76	1.1	1.1KW	45	2					
	11.0	13.2	13.2	0.84	1.1		47	2.3					
NES(O) 50-32-200 A	5.7	1.6	13.8	0.58	0.75	Y90S-4	37	1.8	205				
	8.6	2.4	12.9	0.69	1.1	1.1KW	44	2					
	10.5	2.9	12.1	0.76	1.1		46	2.3					
NES(O) 50-32-200 B	5.5	1.5	12.5	0.51	0.75	Y2-802-4	37	1.8	195				
	8.2	2.3	11.6	0.60	0.75	0.75KW	44	2					
	10.0	2.8	11.0	0.66	0.75		46	2.3					

Type	CaNES(O)city (Q)		Head H	Speed n	Power		Mating motor	Eff	NPS HR	Impeller dia	Dia of Pump		Weight
					Shaft Power	Motor Power					Inlet	Outle	
	m ³ /h	L/s	m	r/min	kw	kw	%	m	mm	mm	mm	kg	
NES(O) 50-32-200 C	5.2	1.4	11.2	1450	0.44	0.75	Y2-802-4	36	1.8	185	50	32	41
	7.8	2.2	10.5		0.52	0.75	0.75KW	43	2				
	9.5	2.6	9.9		0.57	0.75		45	2.3				
NES(O) 50-32-200 D	4.9	1.4	10.0		0.38	0.55	Y2-801-4	36	1.8	175			
	7.4	2.0	9.4		0.44	0.55	0.55KW	43	2				
	9.0	2.5	8.8		0.49	0.55		45	2.3				
NES(O) 50-32-200 E	4.6	1.3	8.9		0.32	0.55	Y2-801-4	35	1.8	165			
	6.9	1.9	8.3		0.37	0.55	0.55KW	42	2				
	8.5	2.4	7.9		0.41	0.55		44	2.3				
NES(O) 50-32-260	7.0	1.9	24.2		1.54	2.2	Y100L ₂ -4	30	1.8	264			
	11.0	3.1	23.0		1.81	2.2	3KW	38	2				
	13.0	3.6	22.0		1.95	3		40	2.4				
NES(O) 50-32-260 A	6.8	1.9	22.6	1.43	2.2	Y100L ₁ -4	29	1.8	255				
	10.6	3.0	21.5	1.68	2.2	2.2KW	37	2					
	12.6	3.5	20.5	1.80	2.2		39	2.4					
NES(O) 50-32-260 B	6.5	1.8	20.8	1.32	2.2	Y100L ₁ -4	28	1.8	245				
	10.2	2.8	19.8	1.53	2.2	2.2KW	36	2					
	12.1	3.4	18.9	1.64	2.2		38	2.4					
NES(O) 50-32-260 C	6.2	1.7	19.2	1.19	2.2	Y100L ₁ -4	28	1.8	235				
	9.8	2.7	18.3	1.37	2.2	2.2KW	36	2					
	11.6	3.2	17.5	1.47	2.2		38	2.4					
NES(O) 50-32-260 D	6.0	1.7	17.8	1.07	1.5	Y90L-4	27	1.8	225				
	9.4	2.6	16.9	1.24	1.5	1.5KW	35	2					
	11.1	3.1	16.1	1.32	1.5		37	2.4					
NES(O) 50-32-260 E	5.7	1.6	16.2	0.95	1.5	Y90L-4	27	1.8	215				
	9.0	2.5	15.4	1.09	1.5	1.5KW	35	2					
	10.6	3.0	14.7	1.17	1.5		37	2.4					
NES(O) 65-40-130	9.0	2.5	6.3	0.30	0.55	Y801-4	52	1.8	139				
	15.0	4.2	5.8	0.36	0.55	0.55KW	65	2					
	18.0	5.0	5.3	0.41	0.55		64	2.4					
NES(O) 65-40-130 A	8.4	2.3	5.5	0.25	0.55	Y801-4	52	1.8	130				
	14.0	3.9	5.1	0.30	0.55	0.55KW	65	2					
	16.8	4.7	4.6	0.33	0.55		64	2.4					
NES(O) 65-40-130 B	7.9	2.2	4.7	0.20	0.55	Y801-4	51	1.8	120				
	13.1	3.6	4.3	0.24	0.55	0.55KW	64	2					
	15.7	4.4	4.0	0.27	0.55		63	2.4					
NES(O) 65-40-130 C	7.4	2.0	3.9	0.16	0.55	Y801-4	51	1.8	110				
	12.3	3.4	3.6	0.19	0.55	0.55KW	64	2					
	14.7	4.1	3.3	0.21	0.55		63	2.4					
NES(O) 65-40-130 D	6.9	1.9	3.3	0.12	0.55	Y801-4	50	1.8	100				
	11.5	3.2	3.0	0.15	0.55	0.55KW	63	2					
	13.8	3.8	2.7	0.17	0.55		62	2.4					

Type	CaNES(O)city (Q)		Head H	Speed n	Power		Mating motor	Eff	NPS HR	Impeller dia	Dia of Pump		Weight
					Shaft Power	Motor Power					Inlet	Outle	
	m ³ /h	L/s	m	r/min	kw	kw	%	m	mm	mm	mm	kg	
NES(O) 65-40-160	9.0	2.5	9.7	1450	0.50	0.55	Y90S-4	48	1.8	174	65	40	36
	15.0	4.2	8.5		0.58	0.75	1.1KW	60	2				
	18.0	5.0	7.6		0.64	1.1		58	2.4				
NES(O) 65-40-160 A	8.5	30.7	8.7		0.43	0.75	Y2-802-4	48	1.8	165			
	14.2	51.2	7.6		0.50	0.75	0.75KW	60	2				
	17.1	61.4	6.8		0.55	0.75		58	2.4				
NES(O) 65-40-160 B	8.0	28.9	7.7		0.36	0.75	Y2-802-4	47	1.8	155			
	13.4	48.1	6.7		0.42	0.75	0.75KW	59	2				
	16.0	57.7	6.0		0.46	0.75		57	2.4				
NES(O) 65-40-160 C	7.5	27.0	6.7		0.30	0.55	Y801-4	47	1.8	145			
	12.5	45.0	5.9		0.34	0.55	0.55KW	59	2				
	15.0	54.0	5.3		0.38	0.55		57	2.4				
NES(O) 65-40-160 D	7.0	25.1	5.8		0.24	0.55	Y801-4	46	1.8	135			
	11.6	41.9	5.1		0.28	0.55	0.55KW	58	2				
	14.0	50.3	4.6		0.31	0.55		56	2.4				
NES(O) 65-40-160 E	6.5	23.3	5.0	0.19	0.55	Y801-4	46	1.8	125				
	10.8	38.8	4.4	0.22	0.55	0.55KW	58	2					
	12.9	46.6	3.9	0.25	0.55		56	2.4					
NES(O) 65-40-200	9.0	2.5	15.2	1450	0.79	1.1	Y90L-4	47	1.8	214	65	40	44
	15.0	4.2	14.0		1.04	1.5	1.5KW	55	2				
	18.0	5.0	12.8		1.16	1.5		54	2.4				
NES(O) 65-40-200 A	8.6	2.4	13.9		0.71	1.1	Y90L-4	46	1.8	205			
	14.4	4.0	12.8		0.93	1.1	1.5KW	54	2				
	17.2	4.8	11.7		1.04	1.5		53	2.4				
NES(O) 65-40-200 B	8.2	2.3	12.6		0.62	1.1	Y90S-4	45	1.8	195			
	13.7	3.8	11.6		0.81	1.1	1.1KW	53	2				
	16.4	4.6	10.6		0.91	1.1		52	2.4				
NES(O) 65-40-200 C	7.8	2.2	11.3		0.46	1.1	Y90S-4	53	1.8	185			
	13.0	3.6	10.4		0.83	1.1	1.1KW	45	2				
	15.6	4.3	9.5		0.77	1.1		53	2.4				
NES(O) 65-40-200 D	7.4	2.1	10.1		0.40	1.1	Y90S-4	52	1.8	175			
	12.4	3.4	9.3		0.60	1.1	1.1KW	52	2				
	14.8	4.1	8.5		0.78	1.1		44	2.4				
NES(O) 65-40-200 E	7.0	1.9	9.0	0.34	1.1	Y90S-4	51	1.8	165				
	11.7	3.2	8.3	0.51	1.1	1.1KW	52	2					
	14.0	3.9	7.6	0.66	1.1		44	2.4					
NES(O) 65-40-260	10.0	2.8	24.0	1450	1.77	2.2	Y100L ₂ -4	37	1.8	264	65	40	61
	16.0	4.4	23.0		2.18	2.2	3KW	46	2				
	20.0	5.6	21.8		2.37	3		50	2.4				
NES(O) 65-40-260 A	9.7	2.7	22.4		1.64	2.2	Y100L ₂ -4	36	1.8	255			
	15.5	4.3	21.5		2.01	3	3KW	45	2				
	19.3	5.4	20.3		2.18	3		49	2.4				

Type	CaNES(O)city (Q)		Head H	Speed n	Power		Mating motor	Eff	NPS HR	Impeller dia	Dia of Pump		Weight
					Shaft Power	Motor Power					Inlet	Outle	
	m ³ /h	L/s	m	r/min	kw	kw	%	m	mm	mm	mm	kg	
NES(O) 65-40-260 B	9.3	2.6	20.7	1450	1.49	2.2	Y100L ₂ -4	35	1.8	245	65	40	61
	14.8	4.1	19.8		1.82	2.2	3KW	44	2				
	18.6	5.2	18.8		1.98	3		48	2.4				
NES(O) 65-40-260 C	8.9	2.5	19.0		1.36	2.2	Y100L ₁ -4	34	1.8	235			
	14.2	4.0	18.2		1.64	2.2	2.2KW	43	2				
	17.8	4.9	17.3		1.78	2.2		47	2.4				
NES(O) 65-40-260 D	8.5	2.4	17.4		1.23	1.5	Y100L ₁ -4	33	1.8	225			
	13.6	3.8	16.7		1.48	2.2	2.2KW	42	2				
	17.0	4.7	15.8		1.60	2.2		46	2.4				
NES(O) 65-40-260 E	8.1	2.3	15.9		1.09	1.5	Y100L ₁ -4	33		215			
	13.0	3.6	15.3		1.30	2.2	2.2KW	42					
	16.3	4.5	14.5		1.41	2.2		46					
NES(O) 65-40-320	11.0	3.0	38.0		3.56	5.5	Y132S-4	32	3.1	329			
	18.0	5.0	35.0		4.23	5.5	5.5KW	41	2.1				
	21.5	6.0	32.0		4.80			39	3.8				
NES(O) 65-40-320 A	10.5	2.9	34.5	3.23	4	Y132S-4	31	3.3	315				
	17.0	4.7	32.0	3.85	5.5	5.5KW	39	2					
	20.5	5.7	29.0	4.32	5.5		38	2.9					
NES(O) 65-40-320 B	10.0	2.8	31.0	2.91	4	Y132S-4	29	3.6	300				
	16.5	4.6	29.0	3.52	5.5	5.5KW	37	2					
	20.0	5.6	26.0	3.93	5.5		36	2.7					
NES(O) 65-40-320 C	9.5	2.6	28.0	2.58	4	Y112 M-	28	3.6	285				
	15.7	4.4	26.2	3.10	4	4KW	36	2					
	19.0	5.3	23.5	3.47	4		35	2.7					
NES(O) 65-40-320 D	9.0	2.5	26.0	2.45	3	Y112 M-	26	3.6	270				
	14.9	4.1	24.4	2.81	4	4KW	35	2					
	18.0	5.0	21.8	3.15	4		34	2.7					
NES(O) 65-40-320 E	8.5	2.4	24.2	2.19	3	Y112 M-	26	3.6	255				
	14.0	3.9	22.6	2.50	4	4KW	35	2					
	17.0	4.7	20.3	2.80	4		34	2.7					
NES(O) 65-50-130	18.0	5.0	6.4	0.51	0.75	Y90S-4	61	2.2	139				
	30.0	8.3	5.8	0.66	0.75	1.1KW	72	2.4					
	36.0	10.0	5.2	0.74	1.1		69	2.8					
NES(O) 65-50-130 A	16.8	4.7	5.6	0.42	0.75	Y90S-4	61	2.2	130				
	28.1	7.8	5.1	0.54	0.75	1.1KW	72	2.4					
	33.7	9.4	4.5	0.61	1.1		69	2.8					
NES(O) 65-50-130 B	15.5	4.3	4.8	0.34	0.75	Y2-802-4	60	2.2	120				
	25.9	7.2	4.3	0.43	0.75	0.75KW	71	2.4					
	31.1	8.6	3.9	0.48	0.75		68	2.8					
NES(O) 65-50-130 C	14.2	4.0	4.0	0.26	0.55	Y801-4	60	2.2	110				
	23.7	6.6	3.6	0.33	0.55	0.55KW	71	2.4					
	28.5	7.9	3.3	0.37	0.55		68	2.8					

Type	CaNES(O)city (Q)		Head H	Speed n	Power		Mating motor	Eff	NPS HR	Impeller dia	Dia of Pump		Weight
					Shaft Power	Motor Power					Inlet	Outle	
	m ³ /h	L/s	m	r/min	kw	kw	%	m	mm	mm	mm	kg	
NES(O) 65-50-160	20.0	5.6	10.3	1450	0.93	1.1	Y90L-4	60	2.3	174	65	50	38
	32.0	8.9	9.5		1.18	1.5	1.5KW	70	2.4				
	38.0	10.6	8.8		1.30	1.5		70	3				
NES(O) 65-50-160 A	19.0	5.3	9.3		0.80	1.1	Y90L-4	60	2.3	165			
	30.3	8.4	8.5		1.02	1.5	1.5KW	70	2.4				
	36.0	10.0	7.9		1.12	1.5		70	3				
NES(O) 65-50-160 B	17.8	4.9	8.2		0.67	1.1	Y90L-4	59	2.3	155			
	28.5	7.9	7.5		0.85	1.1	1.5KW	69	2.4				
	33.9	9.4	7.0		0.93	1.5		69	3				
NES(O) 65-50-160 C	16.7	4.6	7.2		0.55	0.75	Y90S-4	59	2.3	145			
	26.7	7.4	6.6		0.70	1.1	1.1KW	69	2.4				
	31.7	8.8	6.1		0.77	1.1		69	3				
NES(O) 65-50-160 D	15.5	4.3	6.2		0.45	0.75	Y90S-4	58	2.3	135			
	24.8	6.9	5.7		0.57	1.1	1.1KW	68	2.4				
	29.5	8.2	5.3		0.63	1.1		68	3				
NES(O) 65-50-160 E	14.4	4.0	5.3	0.36	0.75	Y2-802-4	58	2.3	125				
	23.0	6.4	4.9	0.45	0.75	0.75KW	68	2.4					
	27.3	7.6	4.5	0.50	0.75		68	3					
NES(O) 65-50-200	18.0	5.0	15.4	1450	1.37	1.5	Y100L ₁ -4	55	2.2	214	65	50	46
	30.0	8.3	13.5		1.70	2.2	2.2KW	65	2.3				
	36.0	10.0	11.6		1.86	2.2		61	2.9				
NES(O) 65-50-200 A	17.2	4.8	14.1		1.23	2.2	Y100L ₁ -4	54	2.2	205			
	28.7	8.0	12.4		1.51	2.2	2.2KW	64	2.3				
	34.5	9.6	10.6		1.67	2.2		60	2.9				
NES(O) 65-50-200 B	16.4	4.6	12.8		1.08	1.5	Y100L ₁ -4	53	2.2	195			
	27.3	7.6	11.2		1.32	2.2	2.2KW	63	2.3				
	32.8	9.1	9.6		1.46	2.2		59	2.9				
NES(O) 65-50-200 C	15.6	4.3	11.5		0.93	1.1	Y90L-4	53	2.2	185			
	25.9	7.2	10.1		1.14	1.5	1.5KW	63	2.3				
	31.1	8.6	8.7		1.26	1.5		59	2.9				
NES(O) 65-50-200 D	14.7	4.1	9.7		0.75	1.1	Y90L-4	52	2.2	175			
	24.5	6.8	8.5		0.92	1.5	1.5KW	62	2.3				
	29.4	8.2	7.3		1.01	1.5		58	2.9				
NES(O) 65-50-200 E	13.9	3.9	8.6	0.63	1.1	Y90L-4	52	2.2	165				
	23.1	6.4	7.6	0.78	1.5	1.5KW	62	2.3					
	27.8	7.7	6.5	0.86	1.5		58	2.9					
NES(O) 65-50-260	20.0	5.6	25.0	1450	2.62	3	Y132S-4	52	2.3	264	65	50	63
	32.0	8.9	22.5		3.27	4	5.5KW	60	2.4				
	38.0	10.6	19.8		3.63	5.5		57	3				
NES(O) 65-50-260 A	19.3	5.4	23.3		2.41	3	Y132S-4	51	2.3	255			
	30.9	8.6	21.0		2.99	4	5.5KW	59	2.4				
	36.7	10.2	18.5		3.33	5.5		56	3				

Type	CaNES(O)city (Q)		Head H	Speed n	Power		Mating motor	Eff	NPS HR	Impeller dia	Dia of Pump		Weight
					Shaft Power	Motor Power					Inlet	Outle	
	m ³ /h	L/s	m	r/min	kw	kw	%	m	mm	mm	mm	kg	
NES(O) 65-50-260 B	18.6	5.2	21.5	1450	2.18	3	Y112 M- 4KW	50	2.3	245	65	50	63
	29.7	8.2	19.4		2.70	4	58	2.4					
	35.3	9.8	17.1		3.00	4	55	3					
NES(O) 65-50-260 C	17.8	4.9	19.8		1.96	3	Y112 M- 4KW	49	2.3	235			
	28.5	7.9	17.8		2.43	3	57	2.4					
	33.8	9.4	15.7		2.70	4	54	3					
NES(O) 65-50-260 D	17.0	4.7	18.2		1.76	3	Y100L ₂ -4 3KW	48	2.3	225			
	27.3	7.6	16.3		2.17	3	56	2.4					
	32.4	9.0	14.4		2.42	3	53	3					
NES(O) 65-50-260 E	16.3	4.5	16.6		1.55	3	Y100L ₂ -4 3KW	48	2.3	215			
	26.1	7.2	14.9		1.91	3	56	2.4					
	30.9	8.6	13.1		2.13	3	52	3					
NES(O) 65-50-320	24.0	6.7	36.0		5.00	5.5	Y160M-4 11KW	47	2	329			
	40.0	11.1	34.0		6.38	7.5	58	2.5					
	48.0	13.3	32.0		7.09	11	59	3.2					
NES(O) 65-50-320 A	23.0	6.4	32.5	4.52	5.5	Y132M-4 7.5KW	45	2	315				
	38.5	10.7	30.6	5.73	7.5	56	2.4						
	46.0	12.8	28.7	6.36	7.5	57	3						
NES(O) 65-50-320 B	22.0	6.1	29.4	4.24	5.5	Y132M-4 7.5KW	42	2	300				
	36.5	10.1	27.7	5.10	7.5	54	2.3						
	44.0	12.2	26.0	5.66	7.5	55	2.8						
NES(O) 65-50-320 C	20.9	5.8	26.5	3.72	5.5	Y132M-4 7.5KW	41	2	285				
	34.7	9.6	24.9	4.44	7.5	53	2.3						
	41.8	11.6	23.4	4.93	7.5	54	2.8						
NES(O) 65-50-320 D	19.8	5.5	23.7	3.24	4	Y132S-4 5.5KW	40	2	270				
	32.9	9.1	22.4	3.85	5.5	52	2.3						
	39.6	11.0	21.0	4.27	5.5	53	2.8						
NES(O) 65-50-320 E	18.8	5.2	21.2	2.77	4	Y132S-4 5.5KW	39	2	255				
	31.1	8.6	20.0	3.28	5.5	52	2.3						
	37.5	10.4	18.7	3.64	5.5	53	2.8						
NES(O) 80-65-130	30.0	8.3	6.2	0.79	1.1	Y90L-4 1.5KW	64	2.2	139				
	50.0	13.9	5.4	0.98	1.1	75	2.4						
	60.0	16.7	4.7	1.05	1.5	73	2.8						
NES(O) 80-65-130 A	28.1	7.8	5.4	0.65	1.1	Y90S-4 1.1KW	64	2.2	130				
	46.8	13.0	4.7	0.81	1.1	75	2.4						
	56.1	15.6	4.1	0.87	1.1	73	2.8						
NES(O) 80-65-130 B	25.9	7.2	4.6	0.52	1.1	Y90S-4 1.1KW	63	2.2	120				
	43.2	12.0	4.0	0.64	1.1	74	2.4						
	51.8	14.4	3.5	0.69	1.1	72	2.8						
NES(O) 80-65-160	30.0	8.3	9.8	1.33	2.2	Y100L ₁ -4 2.2KW	60	2	174				
	50.0	13.9	8.8	1.62	2.2	74	2.2						
	60.0	16.7	7.9	1.76	2.2	74	2.5						

Type	CaNES(O)city (Q)		Head H	Speed n	Power		Mating motor	Eff	NPS HR	Impeller dia	Dia of Pump		Weight				
					Shaft Power	Motor Power					Inlet	Outle					
	m ³ /h	L/s	m	r/min	kw	kw	%	m	mm	mm	mm	kg					
NES(O) 80-65-160 A	28.4	7.9	8.8	1450	1.15	2.2	Y100L ₁ -4	60	2	165	80	65	43				
	47.4	13.2	7.9		1.39	2.2	2.2KW	74	2.2								
	56.9	15.8	7.1		1.51	2.2		73	2.5								
NES(O) 80-65-160 B	26.7	7.4	7.8		0.96	1.1	Y90L-4	59	2	155							
	44.5	12.4	7.0		1.16	1.1	1.5KW	73	2.2								
	53.4	14.8	6.3		1.26	1.5		73	2.5								
NES(O) 80-65-160 C	25.0	6.9	6.8		0.79	1.1	Y90L-4	59	2	145							
	41.7	11.6	6.1		0.96	1.5	1.5KW	73	2.2								
	50.0	13.9	5.5		1.04	1.5		72	2.5								
NES(O) 80-65-160 D	23.3	6.5	5.9		0.64	1.1	Y90S-4	58	2	135							
	38.8	10.8	5.3		0.78	1.1	1.1KW	72	2.2								
	46.6	12.9	4.8		0.84	1.1		72	2.5								
NES(O) 80-65-160 E	21.6	6.0	5.1		0.52	1.1	Y90S-4	58	2	125							
	35.9	10.0	4.5		0.62	1.1	1.1KW	72	2.2								
	43.1	12.0	4.1		0.67	1.1		71	2.5								
NES(O) 80-65-200	35.0	9.7	15.3	1450	2.31	3	Y112 M-	63	1.9	214	80	65	52				
	55.0	15.3	14.0		2.87	4	4KW	73	2								
	66.0	18.3	13.1		3.20	4		74	2.3								
NES(O) 80-65-200 A	33.5	9.3	14.0		2.07	3	Y112 M-	62	1.9	205							
	52.7	14.6	12.8		2.56	4	4KW	72	2								
	63.2	17.6	12.0		2.85	4		73	2.3								
NES(O) 80-65-200 B	31.9	8.9	12.7		1.81	2.2	Y100L ₂ -4	61	1.9	195							
	50.1	13.9	11.6		2.23	3	3KW	71	2								
	60.1	16.7	10.9		2.49	3		72	2.3								
NES(O) 80-65-200 C	30.3	8.4	11.4		1.56	2.2	Y100L ₁ -4	61	1.9	185							
	47.5	13.2	10.5		1.92	2.2	2.2KW	71	2								
	57.1	15.8	9.8		2.14	2.2		71	2.3								
NES(O) 80-65-200 D	28.6	8.0	10.2		1.33	1.5	Y100L ₁ -4	60	1.9	175							
	45.0	12.5	9.4		1.64	2.2	2.2KW	70	2								
	54.0	15.0	8.8		1.83	2.2		71	2.3								
NES(O) 80-65-200 E	26.3	7.3	9.1		1.09	1.5	Y100L ₁ -4	60	1.9	165							
	41.3	11.5	8.3		1.35	2.2	2.2KW	70	2								
	49.6	13.8	7.8		1.50	2.2		70	2.3								
NES(O) 80-65-260	36.0	10.0	24.5		1450	4.00	5.5	Y132M-4	60	2				264	80	65	81
	60.0	16.7	22.5			5.25	7.5	7.5KW	70	2.3							
	72.0	20.0	20.6			5.77	7.5		70	3							
NES(O) 80-65-260 A	34.8	9.7	22.9	3.67		5.5	Y132M-4	59	2	255							
	58.0	16.1	21.0	4.80		7.5	7.5KW	69	2.3								
	69.5	19.3	19.2	5.27		7.5		69	3								
NES(O) 80-65-260 B	33.4	9.3	21.1	3.31		5.5	Y132S-4	58	2	245							
	55.7	15.5	19.4	4.32		5.5	5.5KW	68	2.3								
	66.8	18.6	17.7	4.75		5.5		68	3								

Type	CaNES(O)city (Q)		Head H	Speed n	Power		Mating motor	Eff	NPS HR	Impeller dia	Dia of Pump		Weight
	m ³ /h	L/s			m	r/min					Shaft Power kw	Motor Power kw	
								%	m	mm	mm	mm	mm
NES(O) 80-65-260 C	32.0	8.9	19.4	1450	2.97	4	Y132S-4	57	2	235	80	65	81
	53.4	14.8	17.8		3.87	5.5	5.5KW	67	2.3				
	64.1	17.8	16.3		4.25	5.5		67	3				
NES(O) 80-65-260 D	30.7	8.5	17.8		2.65	4	Y132S-4	56	2	225			
	51.1	14.2	16.3		3.45	5.5	5.5KW	66	2.3				
	61.4	17.0	15.0		3.79	5.5		66	3				
NES(O) 80-65-260 E	29.3	8.1	16.2		2.34	4	Y132S-4	56	2	215			
	48.9	13.6	14.9		3.03	5.5	5.5KW	66	2.3				
	58.6	16.3	13.7		3.33	5.5		66	3				
NES(O) 80-65-320	40.0	11.1	37.0	1450	7.46	11	Y160L-4	54	1.9	329	80	65	110
	65.0	18.1	34.0		9.55	11	15KW	63	2				
	78.0	21.7	31.0		10.62	15		62	2.5				
NES(O) 80-65-320 A	37.0	10.3	33.4		6.73	11	Y160M-4	50	1.9	315			
	62.0	17.2	30.9		8.55	11	11KW	61	2				
	74.5	20.7	28.0		9.46	11		60	2.3				
NES(O) 80-65-320 B	34.0	9.4	30.5		5.76	7.5	Y160M-4	49	2	300			
	56.5	15.7	28.0		7.18	11	11KW	60	2				
	68.0	18.9	25.8		8.09	11		59	2.1				
NES(O) 80-65-320 C	32.3	9.0	27.5		5.04	7.5	Y160M-4	48	2	285			
	53.7	14.9	25.3		6.26	11	11KW	59	2				
	64.6	17.9	23.3		7.06	11		58	2.1				
NES(O) 80-65-320 D	30.6	8.5	24.7		4.38	7.5	Y132M-4	47	2	270			
	50.9	14.1	22.7		5.41	7.5	7.5KW	58	2				
	61.2	17.0	20.9		6.11	7.5		57	2.1				
NES(O) 80-65-320 E	28.9	8.0	22.0		3.73	7.5	Y132M-4	47	2	255			
	48.0	13.3	20.2		4.60	7.5	7.5KW	58	2				
	57.8	16.1	18.6		5.19	7.5		57	2.1				
NES(O) 100-80-160	50.0	13.9	9.9	1450	2.21	3	Y100L ₂ -4	61	2.1	174	100	80	56
	80.0	22.2	9.0		2.55	3	3KW	77	2.5				
	96.0	26.7	8.3		2.75	3		79	3.2				
NES(O) 100-80-160 A	47.4	13.2	8.9		1.90	3	Y100L ₂ -4	61	2.1	165			
	75.9	21.1	8.1		2.18	3	3KW	77	2.5				
	91.0	25.3	7.5		2.36	3		79	3.2				
NES(O) 100-80-160 B	45.0	12.5	7.9		1.60	2.2	Y100L ₁ -4	60	2.1	155			
	71.9	20.0	7.1		1.84	2.2	2.2KW	76	2.5				
	86.3	24.0	6.6		1.98	2.2		78	3.2				
NES(O) 100-80-160 C	42.6	11.8	6.9		1.34	2.2	Y100L ₁ -4	60	2.1	145			
	68.2	18.9	6.3		1.54	2.2	2.2KW	76	2.5				
	81.9	22.7	5.8		1.66	2.2		78	3.2				
NES(O) 100-80-160 D	40.4	11.2	6.0		1.11	2.2	Y100L ₁ -4	59	2.1	135			
	64.7	18.0	5.4		1.27	2.2	2.2KW	75	2.5				
	77.6	21.6	5.0		1.37	2.2		77	3.2				

Type	CaNES(O)city (Q)		Head H	Speed n	Power		Mating motor	Eff	NPS HR	Impeller dia	Dia of Pump		Weight
	m ³ /h	L/s			m	r/min					Shaft Power kw	Motor Power kw	
			mm	mm									
NES(O) 100-80-200	58.0	16.1	15.5	1450	3.77	5.5	Y132M-4	65	2.1	214	100	80	70
	95.0	26.4	14.0		4.64	7.5	7.5KW	78	2.5				
	112.0	31.1	13.0		5.15	7.5		77	3.2				
NES(O) 100-80-200 A	55.6	15.4	14.2		3.36	5.5	Y132S-4	64	2.1	205			
	91.0	25.3	12.8		4.13	5.5	5.5KW	77	2.5				
	107.3	29.8	11.9		4.58	5.5		76	3.2				
NES(O) 100-80-200 B	52.9	14.7	12.9		2.94	4	Y132S-4	63	2.1	195			
	86.6	24.0	11.6		3.60	5.5	5.5KW	76	2.5				
	102.1	28.3	10.8		4.00	5.5		75	3.2				
NES(O) 100-80-200 C	50.1	13.9	11.6		2.53	3	Y112 M-	63	2.1	185			
	82.1	22.8	10.5		3.10	4	4KW	76	2.5				
	96.8	26.9	9.7		3.44	4		75	3.2				
NES(O) 100-80-200 D	47.4	13.2	10.4		2.16	3	Y112 M-	62	2.1	175			
	77.7	21.6	9.4		2.64	4	4KW	75	2.5				
	91.6	25.4	8.7		2.93	4		74	3.2				
NES(O) 100-80-200 E	43.6	12.1	9.2	1.78	3	Y112 M-	62	2.1	165				
	71.4	19.8	8.3	2.17	4	4KW	75	2.5					
	84.2	23.4	7.7	2.41	4		74	3.2					
NES(O) 100-80-260	58.0	16.1	23.5	1450	5.80	7.5	Y160M-4	64	2.1	264	100	80	91
	95.0	26.4	21.5		7.51	11	11KW	74	2.5				
	112.0	31.1	20.0		8.35	11		73	3.2				
NES(O) 100-80-260 A	56.0	15.6	21.9		5.31	7.5	Y160M-4	63	2.1	255			
	91.8	25.5	20.1		6.86	11	11KW	73	2.5				
	108.2	30.1	18.7		7.63	11		72	3.2				
NES(O) 100-80-260 B	53.8	15.0	20.2		4.78	7.5	Y160M-4	62	2.1	245			
	88.2	24.5	18.5		6.17	11	11KW	72	2.5				
	103.9	28.9	17.2		6.86	11		71	3.2				
NES(O) 100-80-260 C	51.6	14.3	18.6		4.29	5.5	Y132M-4	61	2.1	235			
	84.6	23.5	17.0		5.52	7.5	7.5KW	71	2.5				
	99.7	27.7	15.8		6.14	7.5		70	3.2				
NES(O) 100-80-260 D	47.3	13.1	17.1		3.67	5.5	Y132M-4	60	2.1	225			
	77.5	21.5	15.6		4.71	7.5	7.5KW	70	2.5				
	91.4	25.4	14.5		5.24	7.5		69	3.2				
NES(O) 100-80-260 E	45.2	12.6	15.6	3.22	4	Y132S-4	60	2.1	215				
	74.1	20.6	14.3	4.14	5.5	5.5KW	70	2.5					
	87.3	24.3	13.3	4.60	5.5		69	3.2					
NES(O) 100-80-320	60.0	16.7	36.0	1450	9.64	15	Y180M-4	61	1.9	329	100	80	120
	100.0	27.8	33.0		12.65	15	18.5KW	71	2				
	120.0	33.3	30.0		14.00	18.5		70	2.6				
NES(O) 100-80-320 A	57.5	16.0	32.4		8.74	11	Y160L-4	58	1.9	315			
	95.5	26.5	29.7		11.19	15	15KW	69	2				
	114.5	31.8	27.0		12.38	15		68	2.3				

Type	CaNES(O)city (Q)		Head H	Speed n	Power		Mating motor	Eff	NPS HR	Impeller dia	Dia of Pump		Weight				
					Shaft Power	Motor Power					Inlet	Outle					
	m ³ /h	L/s	m	r/min	kw	kw	%	m	mm	mm	mm	kg					
NES(O) 100-80-320 B	54.5	15.1	29.3	1450	7.76	11	Y160L-4	56	1.9	300	100	80	120				
	91.0	25.3	26.8		9.91	15	15KW	67	2								
	109.0	30.3	24.5		11.01	15		66	2.2								
NES(O) 100-80-320 C	51.8	14.4	26.4		6.78	11	Y160L-4	55	1.9	285							
	86.5	24.0	24.2		8.62	11	15KW	66	2								
	103.6	28.8	22.1		9.59	15		65	2.2								
NES(O) 100-80-320 D	49.1	13.6	23.7		5.87	7.5	Y160M-4	54	1.9	270							
	81.9	22.8	21.7		7.45	11	11KW	65	2								
	98.1	27.3	19.8		8.28	11		64	2.2								
NES(O) 100-80-320 E	46.3	12.9	21.2		4.99	7.5	Y160M-4	54		255							
	77.4	21.5	19.4		6.32	11	11KW	65									
	92.7	25.7	17.7		7.03	11		64									
NES(O) 100-80-400	60.0	16.7	58.0		1450	18.95	22	Y200L-4	50	2.2				409	100	80	161
	100.0	27.8	53.0			24.05	30	30KW	60	2.5							
	120.0	33.3	48.0			26.58	30		59	3.4							
NES(O) 100-80-400 A	58.0	16.1	53.7	1450	17.66	22	Y200L-4	48	2.2	395							
	96.5	26.8	48.9		22.15	30	30KW	58	2.4								
	116.0	32.2	44.4		24.60	30		57	3.2								
NES(O) 100-80-400 B	56.0	15.6	49.4		16.37	22	Y200L-4	46	2.2	380							
	93.0	25.8	45.0		20.34	30	30KW	56	2.4								
	111.5	31.0	40.9		22.57	30		55	3								
NES(O) 100-80-400 C	54.0	15.0	46.0		15.03	18.5	Y180L-4	45	2.2	365							
	90.0	25.0	42.0		18.71	22	22KW	55	2.3								
	108.0	30.0	38.0		20.69	22		54	2.8								
NES(O) 100-80-400 D	51.8	14.4	42.3		13.87	15	Y180L-4	43	2.2	350							
	86.3	24.0	38.6		17.12	18.5	22KW	53	2.3								
	103.6	28.8	34.9		18.94	22		52	2.8								
NES(O) 100-80-400 E	49.6	13.8	38.7		12.30	15	Y180L-4	43	2.2	335							
	82.6	22.9	35.4		15.15	18.5	22KW	53	2.3								
	99.1	27.5	32.0		16.77	22		52	2.8								
NES(O) 125-100-160	86.0	23.9	9.5	1450	3.18	4	Y112 M-	70	2.3	190	125	100	71				
	100.0	27.8	8.7		3.29	4	4KW	72	2.5								
	135.0	37.5	6.0		3.68	4		60	3.3								
NES(O) 125-100-160 A	81.5	22.6	8.5		2.72	3	Y112 M-	70	2.3	180							
	94.7	26.3	7.8		2.82	3	4KW	72	2.5								
	127.9	35.5	5.4		3.15	4		60	3.3								
NES(O) 125-100-160 B	76.9	21.4	7.6		2.31	3	Y100L2-	69	2.3	170							
	89.5	24.9	7.0		2.39	3	3KW	71	2.5								
	120.8	33.6	4.8		2.68	3		59	3.3								
NES(O) 125-100-160 C	72.4	20.1	6.7		1.94	2.2	Y100L2-	69	2.3	160							
	84.2	23.4	6.2		2.01	2.2	3KW	71	2.5								
	113.7	31.6	4.3		2.25	3		59	3.3								

Type	CaNES(O)city (Q)		Head H	Speed n	Power		Mating motor	Eff	NPS HR	Impeller dia	Dia of Pump		Weight
	m ³ /h	L/s			m	r/min					Shaft Power	Motor Power	
			kw	kw			%	m	mm	mm	kg		
NES(O) 125-100-200	90.0	25.0	15.0	1450	5.25	7.5	Y160M-4	70	2.2	214	125	100	85
	142.0	39.4	13.0		6.36	7.5	11KW	79	2.5				
	170.0	47.2	11.5		6.91	11		77	3.4				
NES(O) 125-100-200 A	86.2	23.9	13.8		4.68	5.5	Y132M-4	69	2.2	205			
	136.0	37.8	11.9		5.66	7.5	7.5KW	78	2.5				
	162.9	45.2	10.6		6.16	7.5		76	3.4				
NES(O) 125-100-200 B	82.0	22.8	12.5		4.09	5.5	Y132M-4	68	2.2	195			
	129.4	35.9	10.8		4.94	5.5	7.5KW	77	2.5				
	154.9	43.0	9.5		5.37	7.5		75	3.4				
NES(O) 125-100-200 C	77.8	21.6	11.2		3.52	4	Y132S-4	68	2.2	185			
	122.8	34.1	9.7		4.24	5.5	5.5KW	77	2.5				
	147.0	40.8	8.6		4.62	5.5		75	3.4				
NES(O) 125-100-200 D	71.5	19.9	9.5		2.75	4	Y132S-4	67	2.2	175			
	112.8	31.3	8.2		3.31	4	5.5KW	76	2.5				
	135.0	37.5	7.3		3.61	5.5		74	3.4				
NES(O) 125-100-200 E	69.4	19.3	8.4	2.39	3	Y112 M-	67	2.2	165				
	109.5	30.4	7.3	2.88	4	4KW	76	2.5					
	131.1	36.4	6.5	3.13	4		74	3.4					
NES(O) 125-100-260	95.0	26.4	24.5	1450	9.18	11	Y160L-4	69	2.3	264	125	100	106
	148.0	41.1	22.0		11.36	15	15KW	78	2.6				
	175.0	48.6	20.0		12.54	15		76	3.5				
NES(O) 125-100-260 A	91.8	25.5	22.9		8.40	11	Y160L-4	68	2.3	255			
	143.0	39.7	20.5		10.37	11	15KW	77	2.6				
	169.0	47.0	18.7		11.45	15		75	3.5				
NES(O) 125-100-260 B	88.2	24.5	21.1		7.56	7.5	Y160M-4	67	2.3	245			
	137.3	38.2	18.9		9.32	11	11KW	76	2.6				
	162.4	45.1	17.2		10.29	11		74	3.5				
NES(O) 125-100-260 C	84.6	23.5	19.4		6.77	7.5	Y160M-4	66	2.3	235			
	131.7	36.6	17.4		8.33	11	11KW	75	2.6				
	155.8	43.3	15.8		9.20	11		73	3.5				
NES(O) 125-100-260 D	81.0	22.5	17.8		6.03	7.5	Y160M-4	65	2.3	225			
	126.1	35.0	16.0		7.41	7.5	11KW	74	2.6				
	149.2	41.4	14.5		8.19	11		72	3.5				
NES(O) 125-100-260 E	77.4	21.5	16.2	5.30	7.5	Y160M-4	65	2.3	215				
	120.5	33.5	14.6	6.51	7.5	11KW	74	2.6					
	142.5	39.6	13.3	7.20	11		72	3.5					
NES(O) 125-100-320	81.0	22.5	37.5	1450	12.72	15	Y180L-4	65	2	329	125	100	134
	135.0	37.5	34.0		16.66	22	22KW	75	2				
	162.0	45.0	30.0		18.38	22		72	2.3				
NES(O) 125-100-320 A	77.5	21.5	33.5		11.49	15	Y180L-4	62	2	315			
	130.0	36.1	30.5		15.20	22	22KW	71	2				
	155.0	43.1	27.0		16.63	22		69	2.2				

Type	CaNES(O)city (Q)		Head H	Speed n	Power		Mating motor	Eff	NPS HR	Impeller dia	Dia of Pump		Weight
	m ³ /h	L/s			m	r/min					Shaft Power	Motor Power	
			kw	kw			%	m	mm	mm	kg		
NES(O) 125-100-320 B	73.5	20.4	30.5	1450	10.43	15	Y180M-4	59	2	300	125	100	134
	123.0	34.2	27.5		13.54	18.5	18.5KW	68	2				
	147.5	41.0	24.5		14.91	18.5		66	2.1				
NES(O) 125-100-320 C	69.8	19.4	27.5		9.10	11	Y160L-4	58	2	285			
	116.9	32.5	24.8		11.78	15	15KW	67	2				
	140.1	38.9	22.1		12.98	15		65	2.1				
NES(O) 125-100-320 D	66.1	18.4	24.7		7.87	11	Y160L-4	57	2	270			
	110.7	30.7	22.3		10.17	11	15KW	66	2				
	132.7	36.9	19.8		11.21	15		64	2.1				
NES(O) 125-100-320 E	62.5	17.4	22.0		6.69	11	Y160L-4	56	2	255			
	104.5	29.0	19.9		8.63	11	15KW	66	2				
	125.4	34.8	17.7		9.51	15		64	2.1				
NES(O) 125-100-400	90.0	25.0	57.0		24.08	30	Y225M-4	58	1.7	409			
	150.0	41.7	52.0		31.23	37	45KW	68	2				
	180.0	50.0	48.5		34.95	45		68	2.7				
NES(O) 125-100-400 A	87.0	24.2	52.5	22.20	30	Y225S-4	56	1.7	395				
	145.0	40.3	48.2	28.83	37	37KW	66	2					
	174.0	48.3	44.5	31.74	37		66	2.5					
NES(O) 125-100-400 B	84.0	23.3	48.5	20.54	30	Y225S-4	54	1.7	380				
	139.5	38.8	44.5	26.40	37	37KW	64	1.9					
	167.5	46.5	41.2	29.35	37		64	2.4					
NES(O) 125-100-400 C	81.0	22.5	45.0	19.08	22	Y200L-4	52	1.7	365				
	135.0	37.5	41.0	24.30	30	30KW	62	1.9					
	162.0	45.0	38.0	27.03	30		62	2.3					
NES(O) 125-100-400 D	77.7	21.6	41.4	17.15	22	Y200L-4	51	1.7	350				
	129.5	36.0	37.7	21.78	22	30KW	61	1.9					
	155.3	43.2	34.9	24.22	30		61	2.3					
NES(O) 125-100-400 E	74.3	20.7	37.9	15.19	22	Y200L-4	51	1.7	335				
	123.9	34.4	34.5	19.25	22	30KW	61	1.9					
	148.7	41.3	32.0	21.42	30		61	2.3					
NES(O) 150-125-200	115.0	32.0	14.2	7.29	11	Y160M-4	61	2.6	214				
	190.0	53.0	12.5	8.51	11	11KW	76	3.5					
	230.0	63.6	11.0	9.06	11		76	3					
NES(O) 150-125-200 A	110.0	30.6	13.0	6.49	11	Y160M-4	60	2.6	205				
	182.0	50.6	11.5	7.60	11	11KW	75	3.5					
	220.0	61.1	10.1	8.07	11		75	3					
NES(O) 150-125-200 B	104.6	29.1	11.8	5.68	7.5	Y132M-4	59	2.6	195				
	173.1	48.1	10.4	6.63	7.5	7.5KW	74	3.5					
	209.3	58.1	9.1	7.04	7.5		74	3					
NES(O) 150-125-200 C	99.3	27.6	10.6	4.89	7.5	Y132M-4	59	2.6	185				
	164.2	45.6	9.4	5.70	7.5	7.5KW	74	3.5					
	198.5	55.1	8.2	6.05	7.5		74	3					

Type	CaNES(O)city (Q)		Head H	Speed n	Power		Mating motor	Eff	NPS HR	Impeller dia	Dia of Pump		Weight
					Shaft Power	Motor Power					Inlet	Outle	
	m ³ /h	L/s	m	r/min	kw	kw	%	m	mm	mm	mm	kg	
NES(O) 150-125-260	144.0	40.0	23.5	1450	13.16	18.5	Y180L-4	70	2.3	264	150	125	115
	240.0	66.7	21.0		16.94	22	22KW	81	2.5				
	288.0	80.0	18.8		18.90	22		78	3.2				
NES(O) 150-125-260 A	139.0	38.6	21.3		12.03	15	Y180L-4	67	2.3	255			
	232.0	64.4	19.2		15.35	22	22KW	79	2.5				
	278.5	77.4	17.0		16.96	22		76	3				
NES(O) 150-125-260 B	134.0	37.2	19.7		11.23	15	Y180M-4	64	2.3	245			
	223.0	61.9	17.5		13.98	18.5	18.5KW	76	2.4				
	267.5	74.3	15.7		15.45	18.5		74	2.8				
NES(O) 150-125-260 C	128.5	35.7	18.1		10.07	11	Y160L-4	63	2.3	235			
	213.9	59.4	16.1		12.50	15	15KW	75	2.4				
	256.6	71.3	14.4		13.82	15		73	2.8				
NES(O) 150-125-260 D	123.1	34.2	16.6		8.98	11	Y160L-4	62	2.3	225			
	204.8	56.9	14.8		11.12	11	15KW	74	2.4				
	245.7	68.2	13.2		12.30	15		72	2.8				
NES(O) 150-125-260 E	117.6	32.7	15.2	7.90	11	Y160L-4	62	2.3	215				
	195.7	54.4	13.5	9.77	11	15KW	74	2.4					
	234.7	65.2	12.1	10.81	15		72	2.8					
NES(O) 150-125-320	120.0	33.3	35.1	1450	18.35	18.5	Y200L-4	63	2.2	329	150	125	163
	200.0	55.6	32.0		23.23	30	30KW	75	2				
	240.0	66.7	29.5		25.87	30		75	2.4				
NES(O) 150-125-320 A	115.0	31.9	31.5		14.94	22	Y200L-4	66	2.1	315			
	191.0	53.1	29.0		19.33	30	30KW	78	2				
	229.0	63.6	26.5		21.18	30		78	2.7				
NES(O) 150-125-320 B	109.0	30.3	28.5		14.09	18.5	Y180L-4	60	2.2	300			
	182.0	50.6	26.0		17.77	22	22KW	73	2				
	218.5	60.7	24.0		19.69	22		73	2.2				
NES(O) 150-125-320 C	103.6	28.8	25.7		12.29	15	Y180M-4	59	2.2	285			
	172.9	48.0	23.5		15.45	18.5	18.5KW	72	2				
	207.6	57.7	21.7		17.12	18.5		72	2.2				
NES(O) 150-125-320 D	98.1	27.2	23.1		10.63	11	Y160L-4	58	2.2	270			
	163.8	45.5	21.1		13.32	15	15KW	71	2				
	196.6	54.6	19.4		14.76	15		71	2.2				
NES(O) 150-125-320 E	92.6	25.7	20.6	9.03	11	Y160L-4	58	2.2	255				
	154.7	43.0	18.8	11.30	15	15KW	70	2					
	185.7	51.6	17.3	12.52	15		70	2.2					
NES(O) 150-125-400	144.0	40.0	58.0	1450	34.45	45	Y280S-4	66	2.2	409	150	125	181
	245.0	68.1	52.0		45.63	55	75KW	76	2.4				
	300.0	83.3	46.0		52.18	75		72	3.2				
NES(O) 150-125-400 A	139.0	38.6	53.5		31.39	37	Y250M-4	65	2.2	395			
	236.5	65.7	48.0		41.76	55	55KW	74	2.4				
	289.0	80.4	42.5		47.77	55		70	3				

Type	CaNES(O)city (Q)		Head H	Speed n	Power		Mating motor	Eff	NPS HR	Impeller dia	Dia of Pump		Weight
					Shaft Power	Motor Power					Inlet	Outle	
	m ³ /h	L/s	m	r/min	kw	kw	%	m	mm	mm	mm	kg	
NES(O) 150-125-400 B	133.5	37.1	49.5	1450	28.55	37	Y250M-4	63	2.2	380	150	125	181
	227.5	63.2	44.0		37.59	45	55KW	73	2.3				
	278.5	77.4	39.0		43.16	55		69	2.8				
NES(O) 150-125-400 C	132.0	36.7	44.8		25.96	30	Y225M-4	62	2.2	365			
	220.0	61.1	40.7		34.33	45	45KW	71	2.3				
	264.0	73.3	36.3		38.94	45		67	2.8				
NES(O) 150-125-400 D	126.6	35.2	41.2		23.27	30	Y225S-4	61	2.2	350			
	211.0	58.6	37.4		30.70	37	37KW	70	2.3				
	253.2	70.3	33.4		34.85	37		66	2.8				
NES(O) 150-125-400 E	121.2	33.7	37.7		20.57	30	Y225S-4	61	2.2	335			
	201.9	56.1	34.3		27.12	37	37KW	70	2.3				
	242.3	67.3	30.6		30.79	37		66	2.8				
NES(O) 200-150-200	216.0	60.0	14.4		12.10	15	Y180M-4	70	3	214			
	360.0	100.0	12.2		14.95	18.5	18.5KW	80	3.5				
	424.8	118.0	10.3		15.47	18.5		77	4				
NES(O) 200-150-200 A	206.9	57.5	13.2	10.71	11	Y160L-4	70	3	205				
	344.9	95.8	11.2	13.22	15	15KW	80	3.5					
	406.9	113.0	9.5	13.69	15		77	4					
NES(O) 200-150-200 B	196.8	54.7	12.0	9.28	11	Y160L-4	69	3	195				
	328.0	91.1	10.1	11.45	15	15KW	79	3.5					
	387.1	107.5	8.6	11.86	15		76	4					
NES(O) 200-150-200 C	186.7	51.9	10.8	7.99	11	Y160L-4	69	3	185				
	311.2	86.4	9.1	9.84	15	15KW	79	3.5					
	367.2	102.0	7.7	10.19	15		76	4					
NES(O) 200-150-200 D	176.6	49.1	9.6	6.81	11	Y160M-4	68	3	175				
	294.4	81.8	8.2	8.38	11	11KW	78	3.5					
	347.4	96.5	6.9	8.68	11		75	4					
NES(O) 200-150-260	194.0	54.0	23.0	17.11	22	Y200L-4	71	2.7	264				
	324.0	90.0	21.0	22.87	30	30KW	81	3					
	414.0	115.0	16.8	25.59	30		74	3.3					
NES(O) 200-150-260 A	186.7	51.9	21.5	15.58	18.5	Y200L-4	70	2.7	255				
	311.8	86.6	19.6	20.79	22	30KW	80	3					
	398.4	110.7	15.7	23.29	30		73	3.3					
NES(O) 200-150-260 B	179.4	49.8	19.8	14.02	15	Y180L-4	69	2.7	245				
	299.5	83.2	18.1	18.67	22	22KW	79	3					
	382.8	106.3	14.5	20.94	22		72	3.3					
NES(O) 200-150-260 C	172.0	47.8	18.2	12.55	15	Y180L-4	68	2.7	235				
	287.3	79.8	16.6	16.68	18.5	22KW	78	3					
	367.1	102.0	13.3	18.74	22		71	3.3					
NES(O) 200-150-260 D	164.7	45.8	16.7	11.10	15	Y180L-4	68	2.7	225				
	275.1	76.4	15.3	14.74	18.5	22KW	78	3					
	351.5	97.6	12.2	16.56	22		71	3.3					

Type	CaNES(O)city (Q)		Head H	Speed n	Power		Mating motor	Eff	NPS HR	Impeller dia	Dia of Pump		Weight
					Shaft Power	Motor Power					Inlet	Outle	
	m ³ /h	L/s	m	r/min	kw	kw	%	m	mm	mm	mm	kg	
NES(O) 200-150-260 E	157.4	43.7	15.3	1450	9.75	15	Y180M-4 18.5KW	67	2.7	215	200	150	148
	262.9	73.0	13.9		12.94	18.5		77	3				
	335.9	93.3	11.1		14.55	18.5		70	3.3				
NES(O) 200-150-320	230.0	63.9	36.0	1450	30.88	37	Y250M-4 55KW	73	2.8	329	200	150	170
	370.0	102.8	33.0		40.53	45		82	3.2				
	445.0	123.6	30.0		44.87	55		81	3.6				
NES(O) 200-150-320 A	220.0	61.1	32.5	1450	27.61	37	Y225M-4 45KW	71	2.8	315	200	150	170
	354.0	98.3	30.0		36.36	45		80	3.1				
	426.0	118.3	27.0		39.89	45		79	3.5				
NES(O) 200-150-320 B	209.5	58.2	29.5	1450	24.38	30	Y225S-4 37KW	69	2.8	300	200	150	170
	337.5	93.8	27.0		31.80	37		78	3				
	405.5	112.6	24.5		35.12	37		77	3.3				
NES(O) 200-150-320 C	199.0	55.3	26.6	1450	21.21	22	Y225S-4 37KW	68	2.8	285	200	150	170
	320.6	89.1	24.4		27.62	30		77	3				
	385.2	107.0	22.1		30.51	37		76	3.3				
NES(O) 200-150-320 D	188.6	52.4	23.9	1450	18.31	22	Y200L-4 30KW	67	2.8	270	200	150	170
	303.8	84.4	21.9		23.79	30		76	3				
	365.0	101.4	19.8		26.29	30		75	3.3				
NES(O) 200-150-320 E	178.1	49.5	21.3	1450	15.54	22	Y200L-4 30KW	67	2.8	255	200	150	170
	286.9	79.7	19.5		20.18	30		76	3				
	344.7	95.7	17.7		22.29	30		75	3.3				
NES(O) 200-150-400	240.0	66.7	54.0	1450	51.13	75	Y280M-4 90KW	69	2.8	409	200	150	209
	385.0	106.9	50.0		66.33	75		79	3.2				
	460.0	127.8	46.0		73.85	90		78	3.6				
NES(O) 200-150-400 A	232.0	64.4	50.0	1450	46.78	55	Y280S-4 75KW	68	2.8	395	200	150	209
	372.0	103.3	46.0		60.50	75		77	3.2				
	444.0	123.3	42.5		65.86	75		78	3.6				
NES(O) 200-150-400 B	223.0	61.9	46.0	1450	42.31	55	Y280S-4 75KW	66	2.8	380	200	150	209
	357.5	99.3	42.0		54.14	75		76	3.1				
	427.5	118.8	39.0		60.92	75		75	3.5				
NES(O) 200-150-400 C	204.0	56.7	43.5	1450	37.16	45	Y250M-4 55KW	65	2.8	365	200	150	209
	340.0	94.4	38.3		47.27	55		75	3				
	408.0	113.3	34.9		52.38	55		74	3.4				
NES(O) 200-150-400 D	195.6	54.3	40.0	1450	33.28	37	Y250M-4 55KW	64	2.8	350	200	150	209
	326.0	90.6	35.2		42.24	45		74	3				
	391.2	108.7	32.1		46.82	55		73	3.4				
NES(O) 200-150-400 E	190.1	52.8	37.8	1450	31.03	37	Y250M-4 55KW	63	2.8	335	200	150	209
	316.8	88.0	33.3		39.30	45		73	3				
	380.2	105.6	30.3		43.57	55		72	3.4				
NES(O) 250-200-260	360.0	100.0	20.0	1450	30.63	30	Y200L-4 30KW	64	3.7	288	250	200	251
	600.0	166.7	15.2		31.03	30		80	2.8				
	720.0	200.0	12.0		29.77	30		79	3.6				

Type	CaNES(O)city (Q)		Head H	Speed n	Power		Mating motor	Eff	NPS HR	Impeller dia	Dia of Pump		Weight
					Shaft Power	Motor Power					Inlet	Outle	
	m ³ /h	L/s	m	r/min	kw	kw	%	m	mm	mm	mm	kg	
NES(O) 250-200-260 A	337.5	93.8	17.6	1450	25.43	22	Y180L-4	64	3.7	270	250	200	251
	562.5	156.3	13.4		25.73	22	22KW	80	2.8				
	675.0	187.5	10.5		24.69	22		79	3.6				
NES(O) 250-200-260 B	318.8	88.5	15.7		21.60	15	Y180M-4	63	3.7	255			
	531.3	147.6	11.9		21.81	18.5	18.5KW	79	2.8				
	637.5	177.1	9.4		20.93	18.5		78	3.6				
NES(O) 250-200-260 C	300.0	83.3	13.9		18.15	15	Y160L-4	63	3.7	240			
	498.0	138.3	10.6		18.23	15	15KW	79	2.8				
	597.7	166.0	8.3		17.49	15		78	3.6				
NES(O) 250-200-320	378.0	105.0	33.0	1450	46.52	55	Y280S-4	73	2.7	329			
	630.0	175.0	27.0		54.48	75	75KW	85	3.8				
	756.0	210.0	20.0		56.38	75		73	3.9				
NES(O) 250-200-320 A	360.0	100.0	30.0		40.27	45	Y250M-4	73	2.6	315			
	600.0	167.0	25.0		50.41	55	55KW	81	3.7				
	720.0	200.0	19.0		51.01	55		73	3.8				
NES(O) 250-200-320 B	342.0	95.0	28.5		37.37	45	Y250M-4	71	2.5	300			
	570.0	158.0	23.0		44.61	55	55KW	80	3.6				
	684.0	190.0	18.5		47.19	55		73	3.7				
NES(O) 250-200-320 C	324.0	90.0	25.5		33.08	37	Y225M-4	68	2.5	285			
	540.0	150.0	21.0		40.09	45	45KW	77	3.6				
	648.0	180.0	16.6		41.24	45		71	3.7				
NES(O) 250-200-320 D	306.9	85.3	22.9		28.54	30	Y225S-4	67	2.5	270			
	511.6	142.1	18.8		34.54	37	37KW	76	3.6				
	613.9	170.5	14.9		35.57	37		70	3.7				
NES(O) 250-200-320 E	289.9	80.5	20.4	24.23	30	Y225S-4	67	2.5	255				
	483.2	134.2	16.8	29.29	37	37KW	76	3.6					
	579.8	161.1	13.3	30.18	37		70	3.7					
NES(O) 250-200-400	390.0	108.0	55.5	1450	76.52	90	Y315M-4	77	3	409			
	650.0	181.0	48.5		99.79	110	132KW	86	3.8				
	780.0	217.0	41.5		108.79	132		81	4.5				
NES(O) 250-200-400 A	378.0	105.0	51.0		68.15	75	Y315S-4	77	2.9	395			
	630.0	175.0	44.0		88.78	110	110KW	85	3.8				
	756.0	210.0	37.0		96.39	110		79	4.4				
NES(O) 250-200-400 B	360.0	100.0	47.0		60.61	75	Y280M-4	76	2.9	380			
	600.0	167.0	40.5		78.75	90	90KW	84	3.7				
	720.0	200.0	33.5		84.18	90		78	4.3				
NES(O) 250-200-400 C	342.0	95.0	43.0		53.38	75	Y280M-4	75	2.9	365			
	570.0	158.0	36.5		68.24	90	90KW	83	3.7				
	684.0	190.0	30.5		73.75	90		77	4.2				
NES(O) 250-200-400 D	324.0	90.0	39.0		46.48	55	Y280S-4	74	2.9	350			
	540.0	150.0	32.5		58.26	75	75KW	82	3.6				
	648.0	180.0	27.0		62.67	75		76	4.1				

Type	CaNES(O)city (Q)		Head H	Speed n	Power		Mating motor	Eff	NPS HR	Impeller dia	Dia of Pump		Weight
					Shaft Power	Motor Power					Inlet	Outle	
	m ³ /h	L/s	m	r/min	kw	kw	%	m	mm	mm	mm	kg	
NES(O) 250-200-400 E	306.0	85.0	34.0	1450	39.34	45	Y280S-4	72	2.8	335	250	200	295
	510.0	142.0	29.0		49.71	55	75KW	81	3.6				
	612.0	170.0	23.5		52.91	75		74	4				
NES(O)300-250-320	504.0	140.0	32.0	1450	62.72	75	Y280M-4	70	3.2	329	300	250	311
	840.0	233.0	29.0		77.11	90	90KW	86	3.4				
	1008.0	280.0	23.0		78.89	90		80	5.5				
NES(O)300-250-320 A	480.0	133.0	29.0	1450	54.13	75	Y280s-4	70	3.2	315	300	250	311
	800.0	222.0	26.0		66.61	75	75KW	85	3.2				
	960.0	267.0	21.0		68.60	75		80	4.8				
NES(O)300-250-320 B	456.0	127.0	26.5	1450	47.67	55	Y280s-4	69	3.3	300	300	250	311
	760.0	211.0	23.5		57.88	75	75KW	84	3.1				
	912.0	253.0	19.0		59.71	75		79	4.1				
NES(O)300-250-320 C	432.0	120.0	24.0	1450	40.90	45	Y250M-4	69	3.3	285	300	250	311
	720.0	200.0	21.0		49.59	55	55KW	83	3.1				
	864.0	240.0	17.0		50.61	55		79	3.7				
NES(O)300-250-320 D	409.3	113.7	21.5	1450	35.29	37	Y225M-4	68	3.3	270	300	250	311
	682.1	189.5	18.8		42.68	45	45KW	82	3.1				
	818.5	227.4	15.3		43.59	45		78	3.7				
NES(O)300-250-320 E	386.5	107.4	19.2	1450	29.95	37	Y225M-4	68	3.3	255	300	250	311
	644.2	178.9	16.8		36.17	45	45KW	82	3.1				
	773.1	214.7	13.6		36.95	45		78	3.7				
NES(O) 300-250-400	540.0	150.0	52.5	1450	102.90	132	Y315L ₁ -4	75	3.3	409	300	250	390
	900.0	250.0	48.5		135.03	160	160KW	88	4.8				
	1080.0	300.0	41.0		148.81	160		81	6.3				
NES(O) 300-250-400 A	522.0	145.0	49.0	1450	92.84	110	Y315L ₁ -4	75	3.3	395	300	250	390
	870.0	242.0	44.5		119.76	132	160KW	88	4.8				
	1044.0	290.0	38.5		133.44	160		82	6.2				
NES(O) 300-250-400 B	504.0	140.0	45.0	1450	81.24	90	Y315M ₁ -	76	3.2	380	300	250	390
	840.0	233.0	40.5		105.24	132	132KW	88	4.7				
	1008.0	280.0	34.5		112.70	132		84	6.2				
NES(O) 300-250-400 C	480.0	133.0	41.0	1450	71.43	90	Y315S-4	75	3.1	365	300	250	390
	800.0	222.0	37.0		91.57	110	110KW	88	4.6				
	960.0	267.0	31.0		96.44	110		84	6				
NES(O) 300-250-400 D	456.0	127.0	38.0	1450	62.89	75	Y315S-4	75	3	350	300	250	390
	760.0	211.0	33.5		78.76	90	110KW	88	4.5				
	912.0	253.0	28.5		84.23	110		84	5.8				
NES(O) 300-250-400 E	432.0	120.0	35.0	1450	55.62	75	Y280M-4	74	3	335	300	250	390
	720.0	200.0	31.0		69.84	90	90KW	87	4.4				
	864.0	240.0	27.0		76.51	90		83	5.5				

50-32-130

Performance Curve

2900 rpm

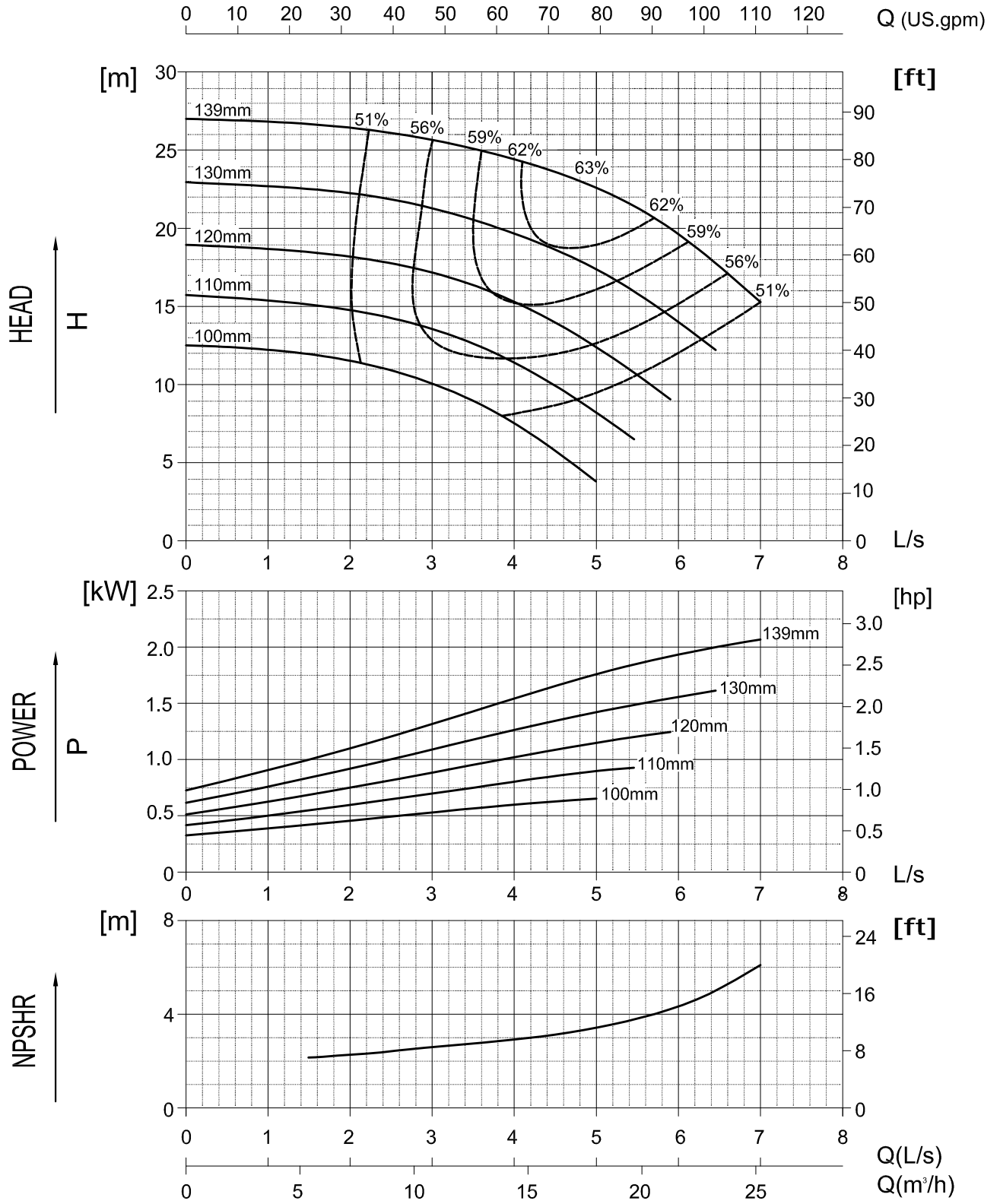

ISO9906-II, Date refers to clean cold water

50-32-160

Performance Curve

2900 rpm

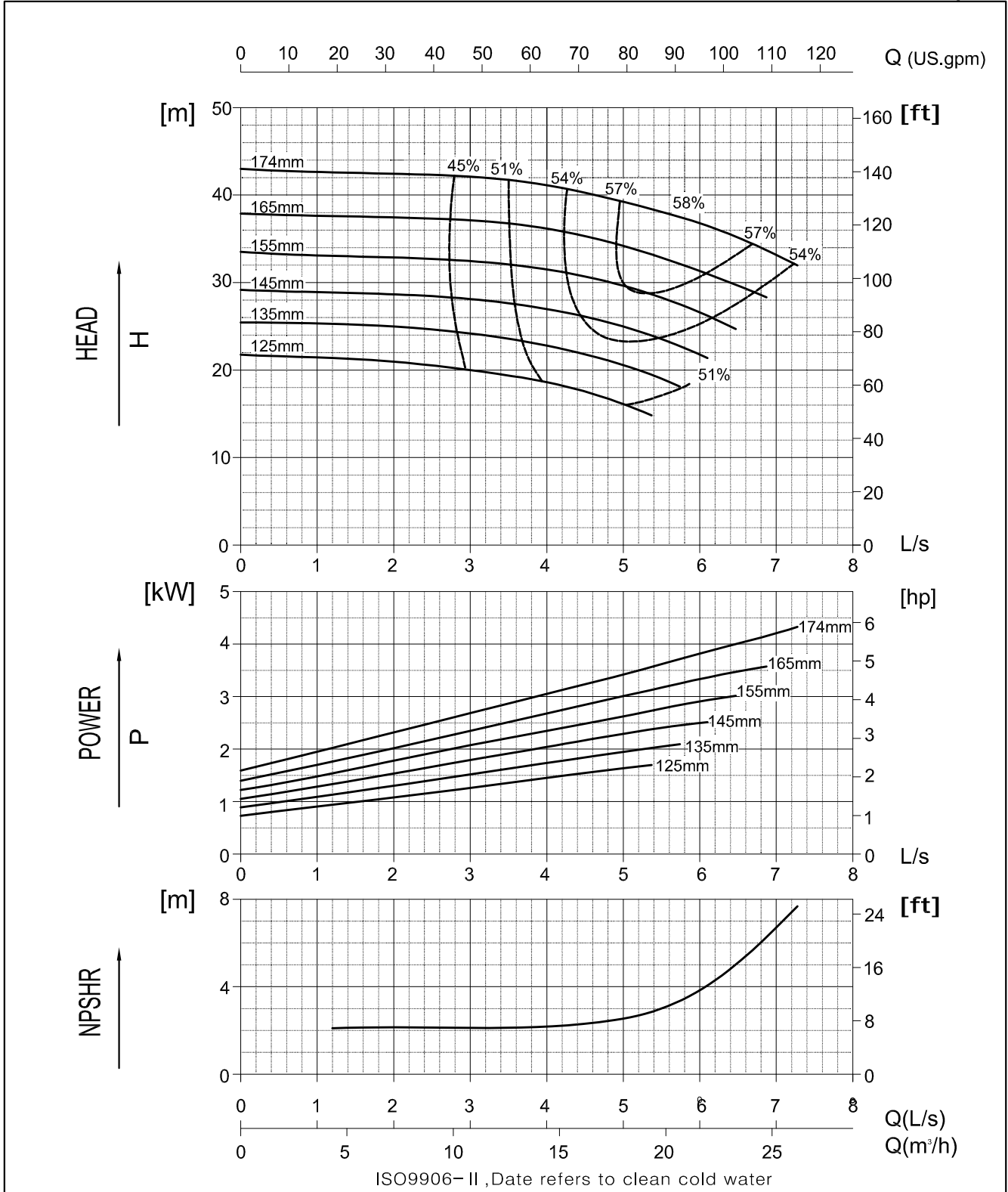

50-32-200

Performance Curve

2900 rpm

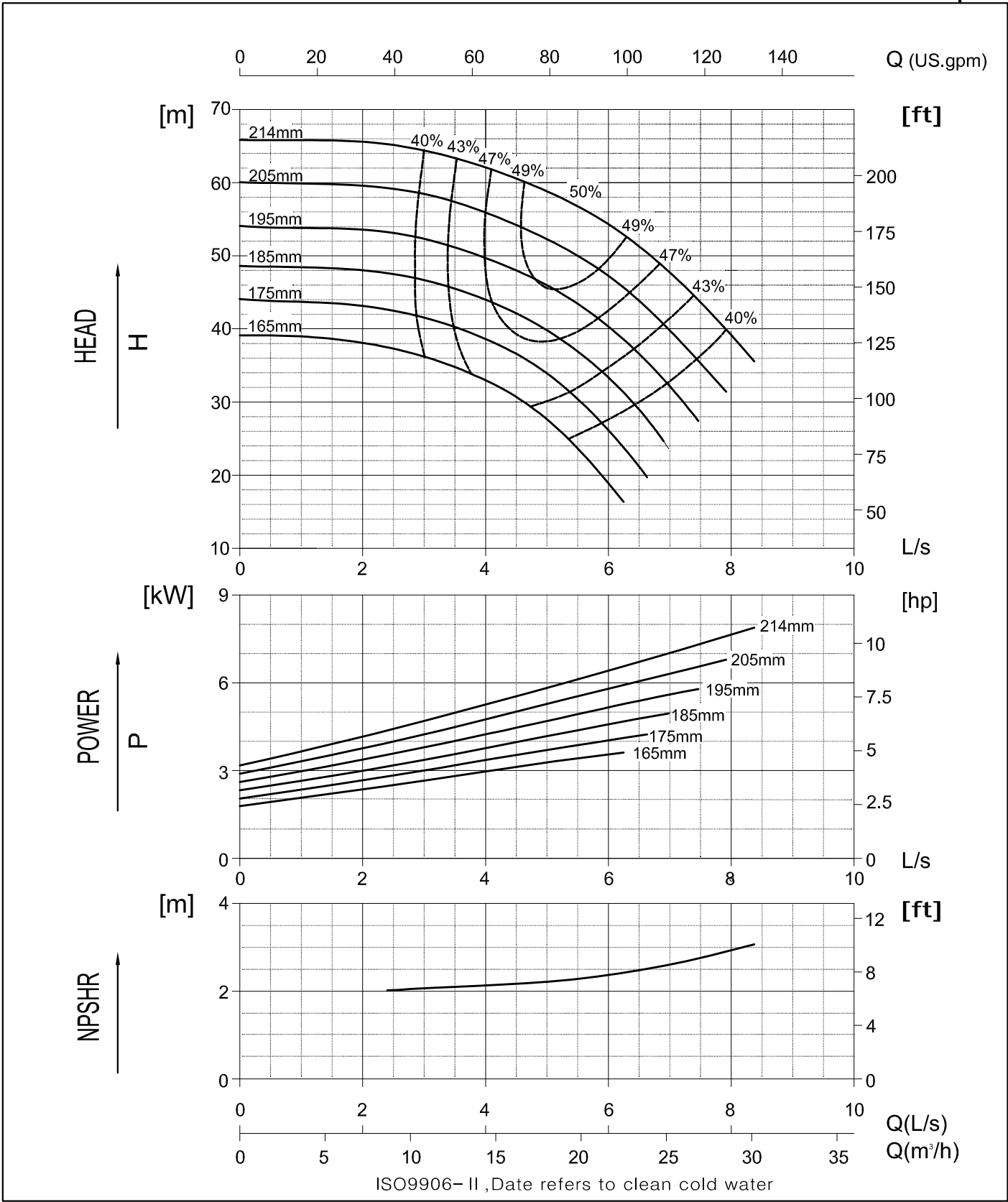

50-32-260

Performance Curve

2900 rpm

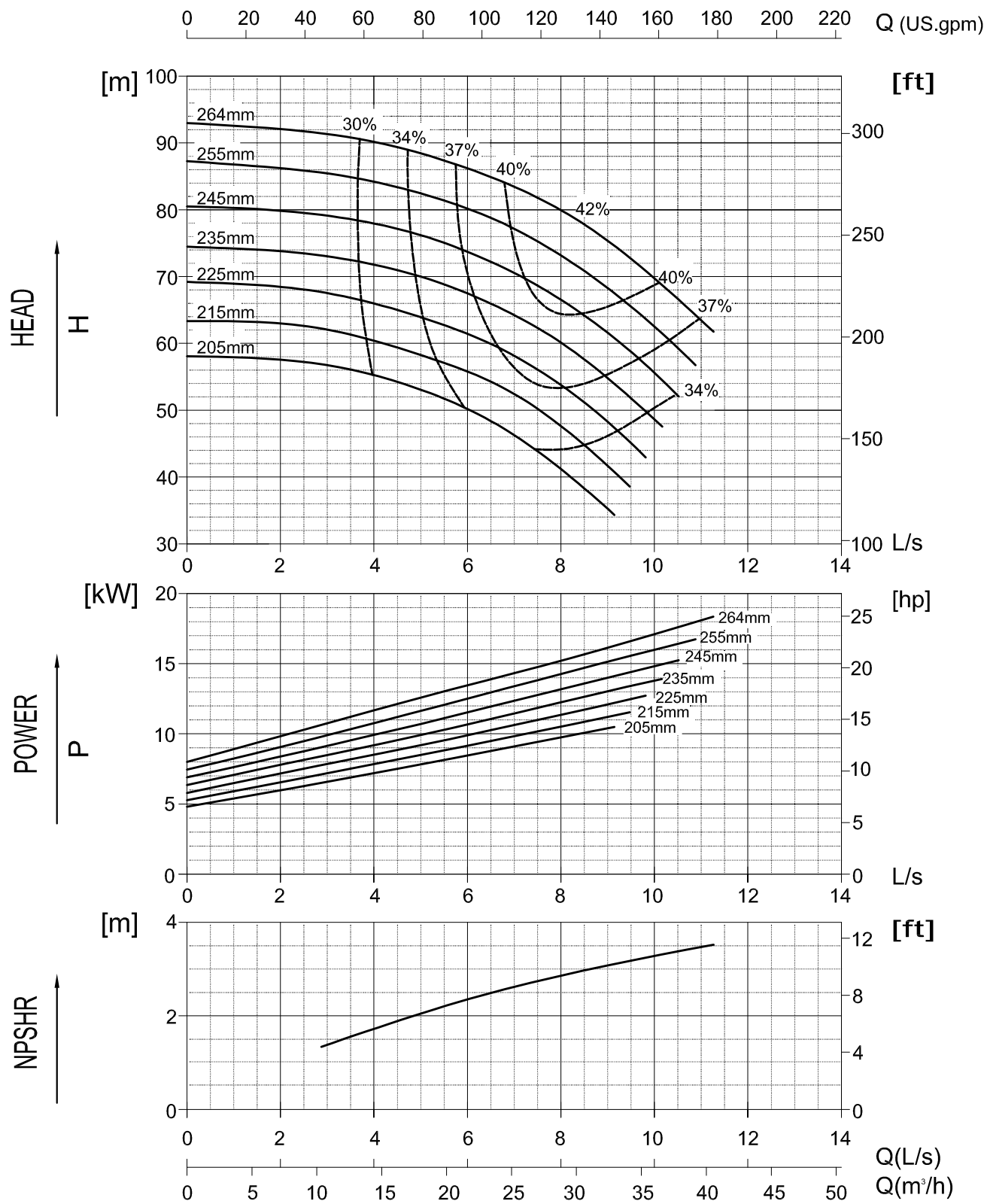

ISO9906-II, Date refers to clean cold water

65-40-130

Performance Curve

2900 rpm

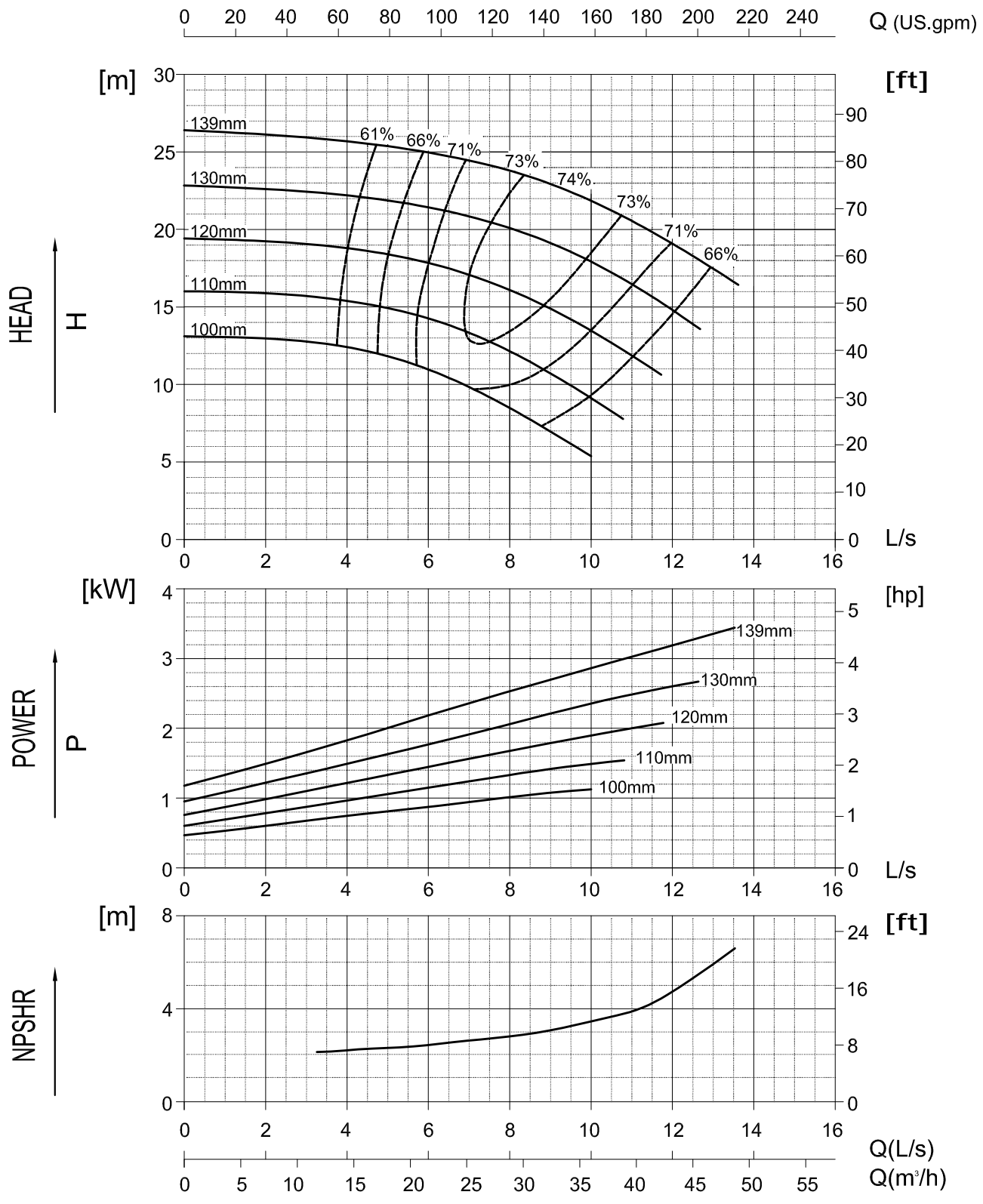

65-40-160

Performance Curve

2900 rpm

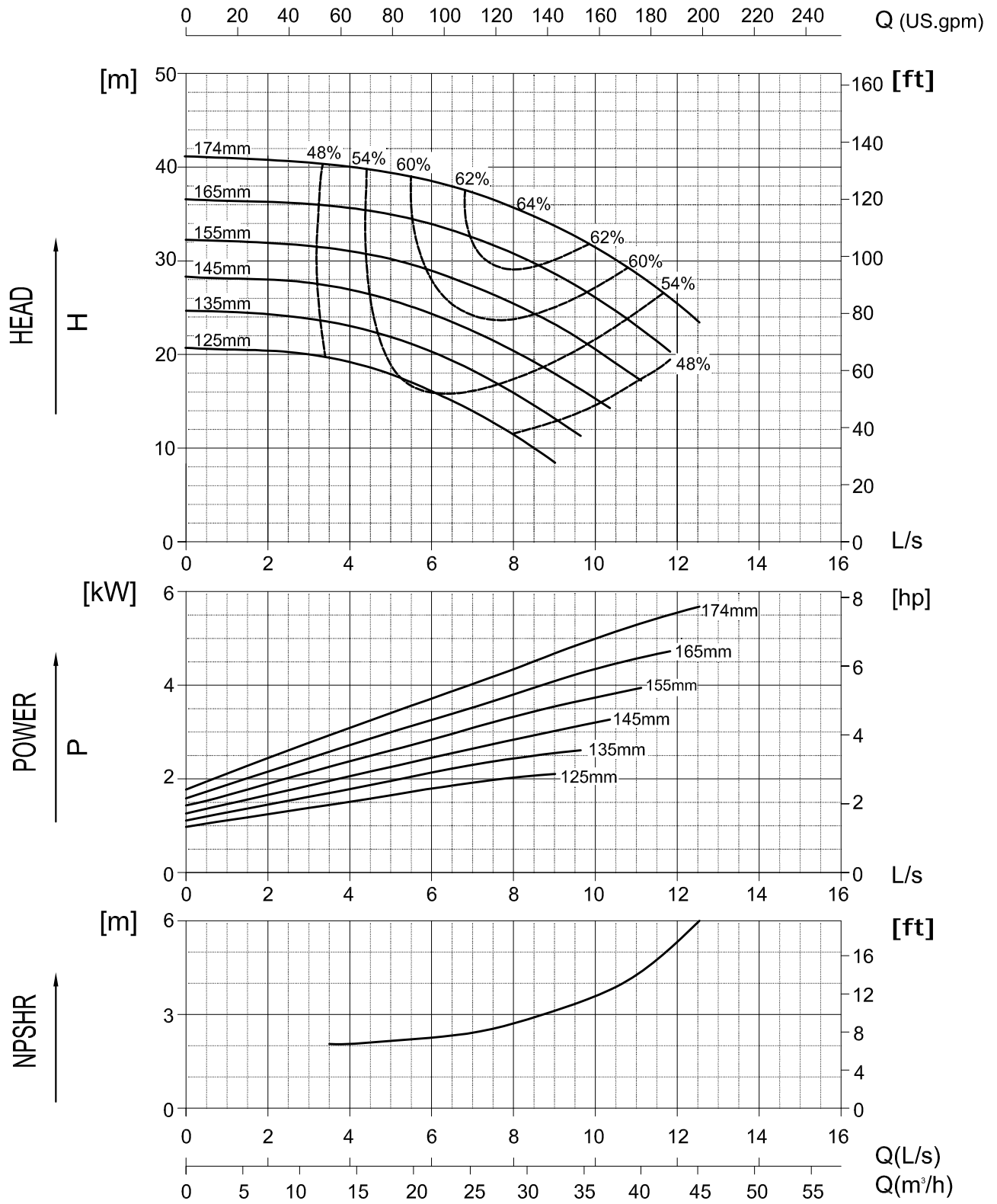

ISO9906-II, Date refers to clean cold water

65-40-200

Performance Curve

2900 rpm

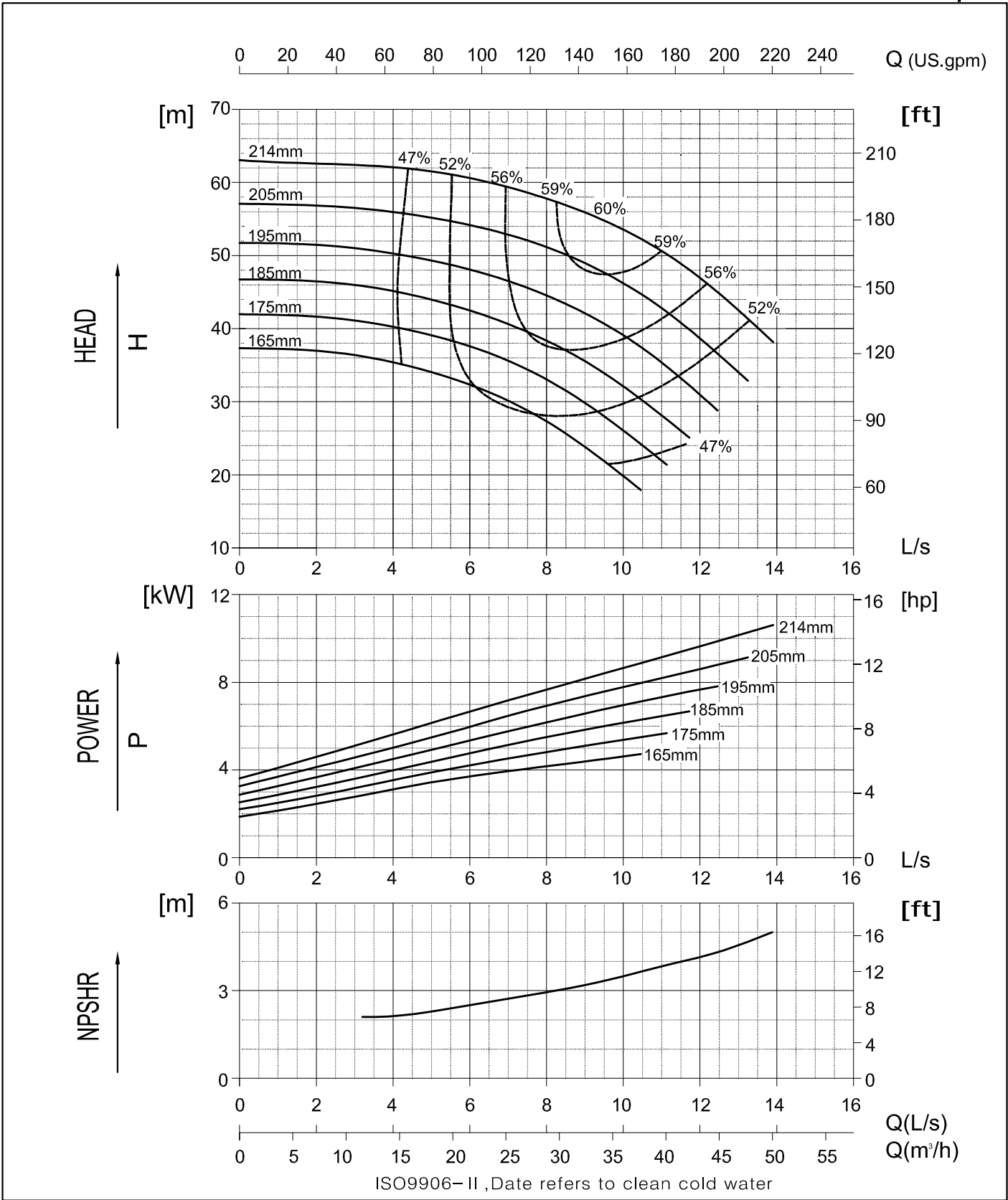

65-40-260

Performance Curve

2900 rpm

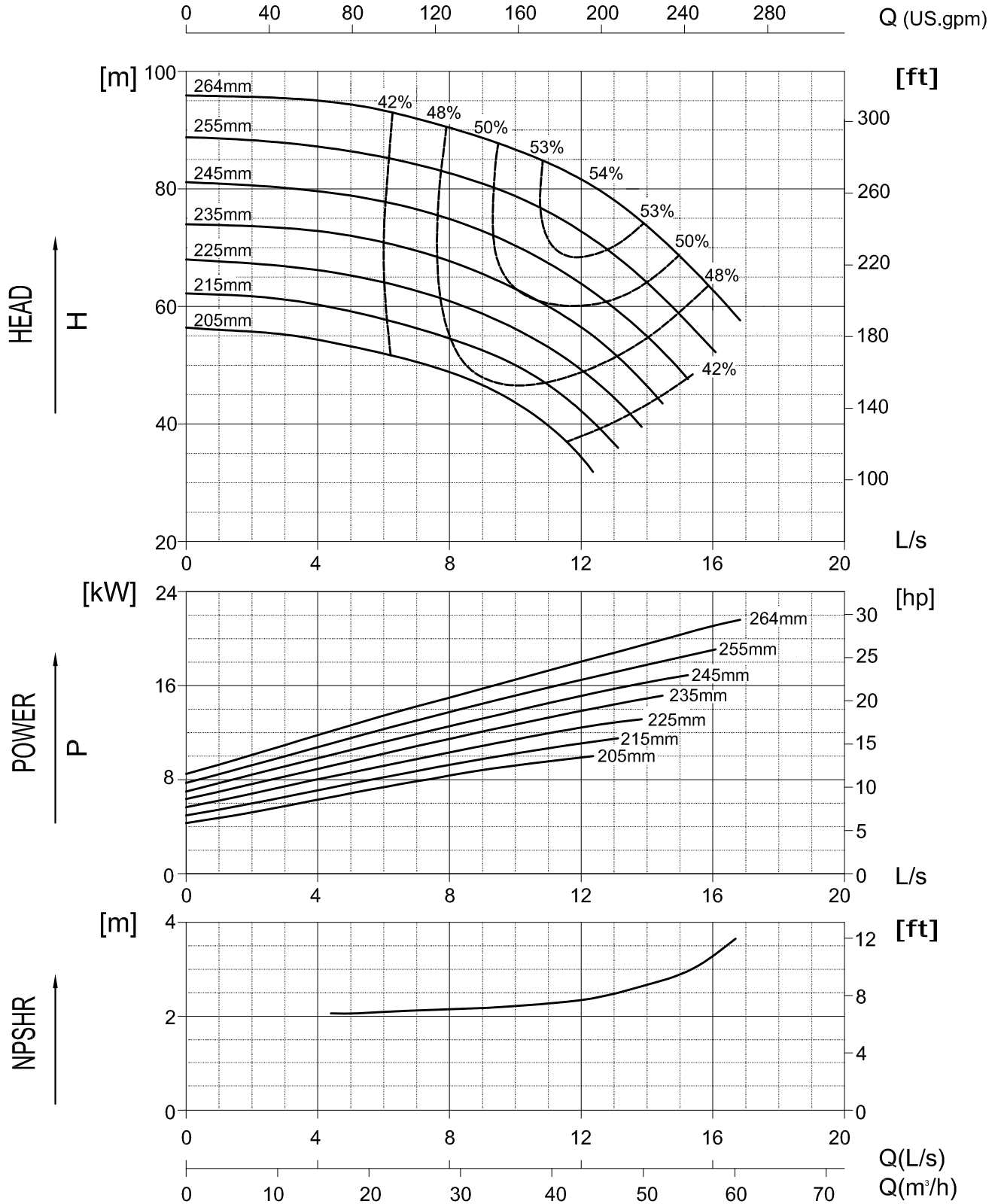

ISO9906-II, Date refers to clean cold water

65-40-320H

Performance Curve

2900 rpm

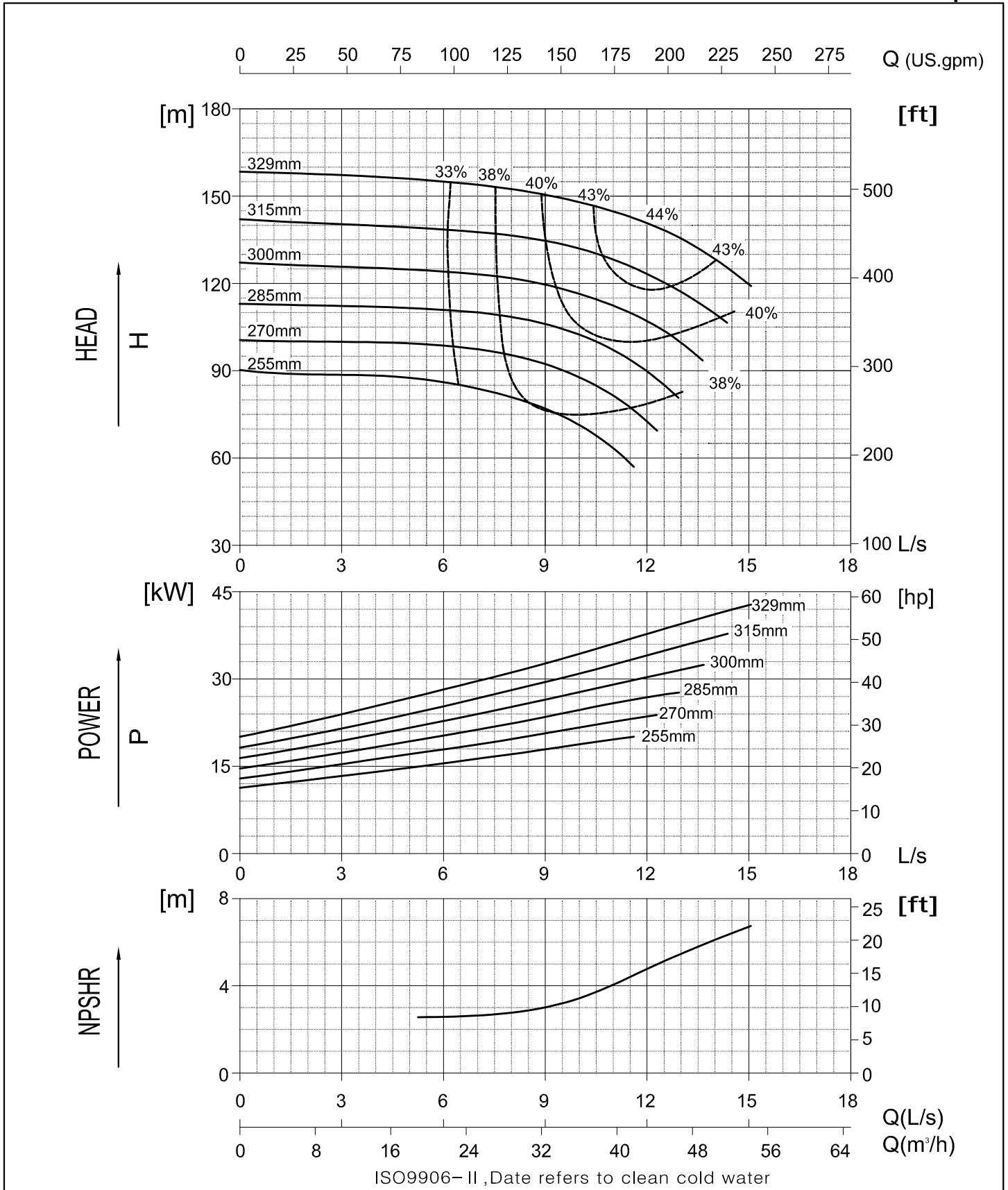

65-50-130

Performance Curve

2900 rpm

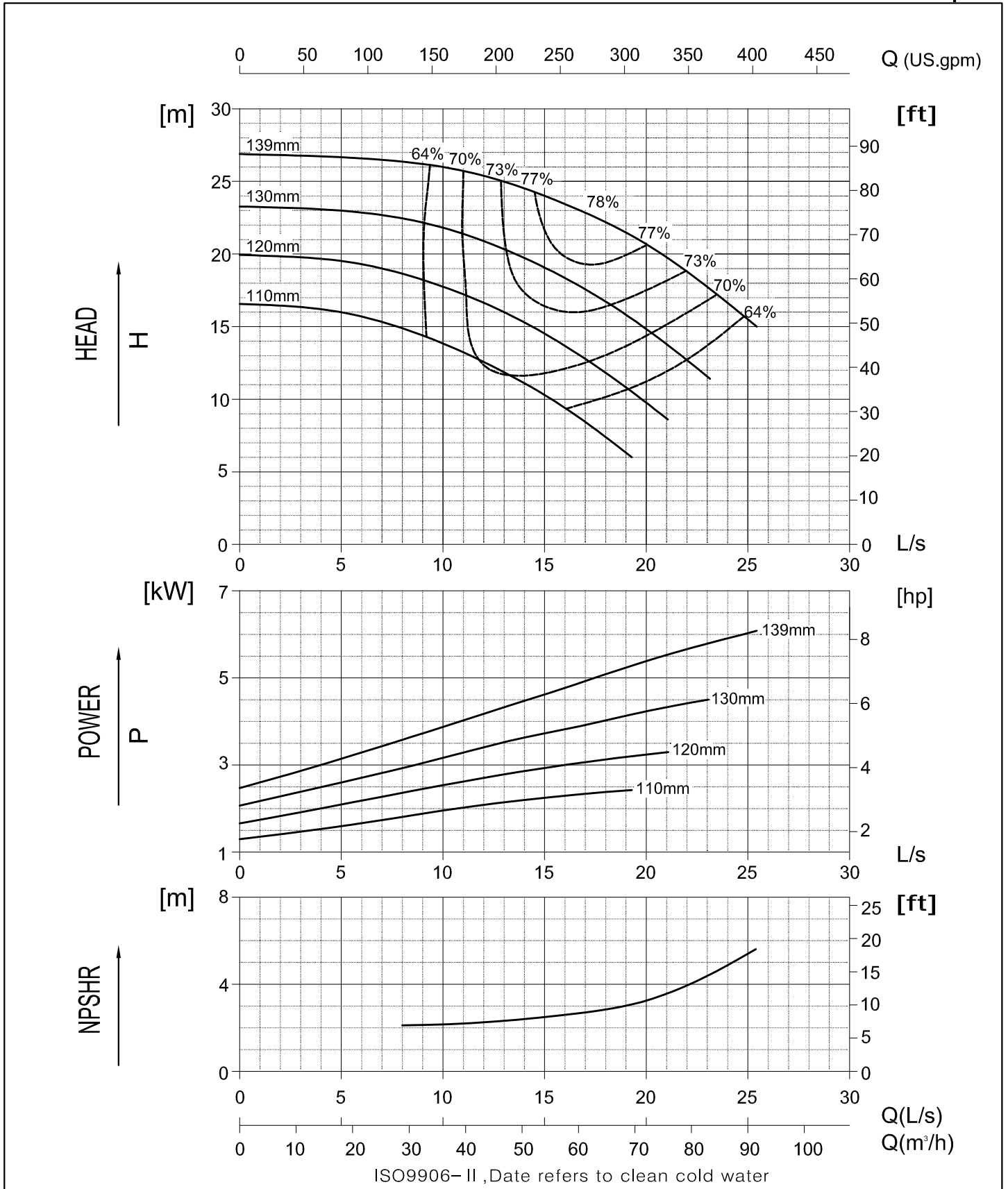

65-50-160

Performance Curve

2900 rpm

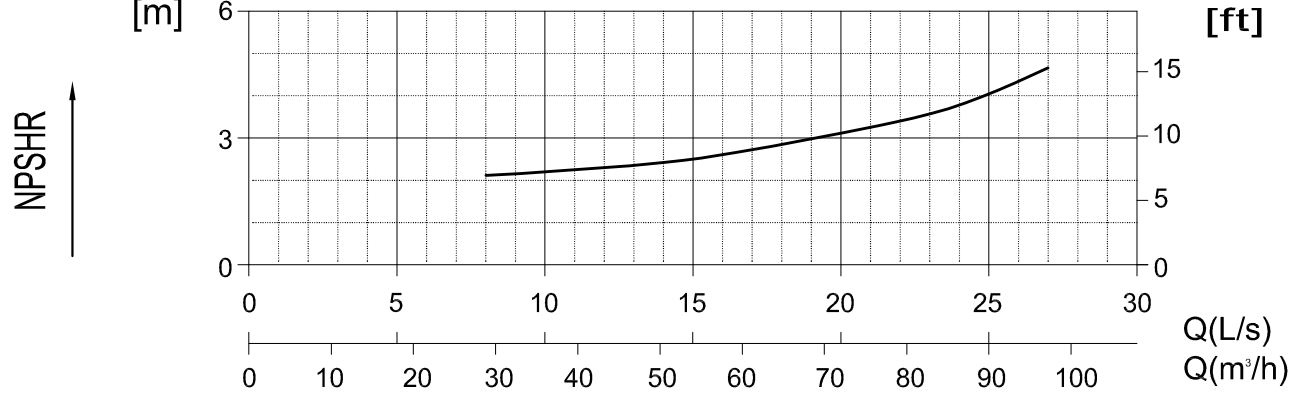
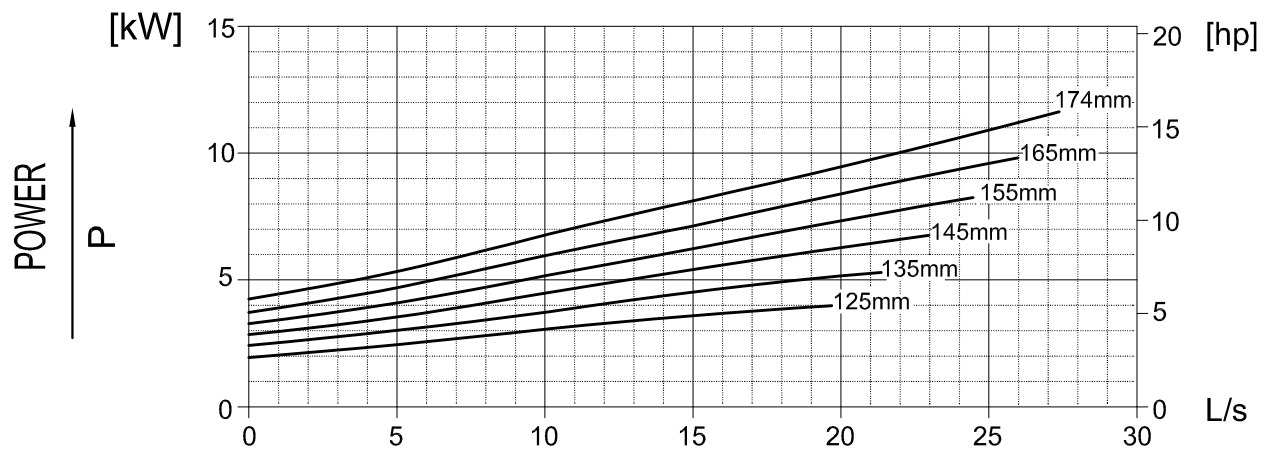
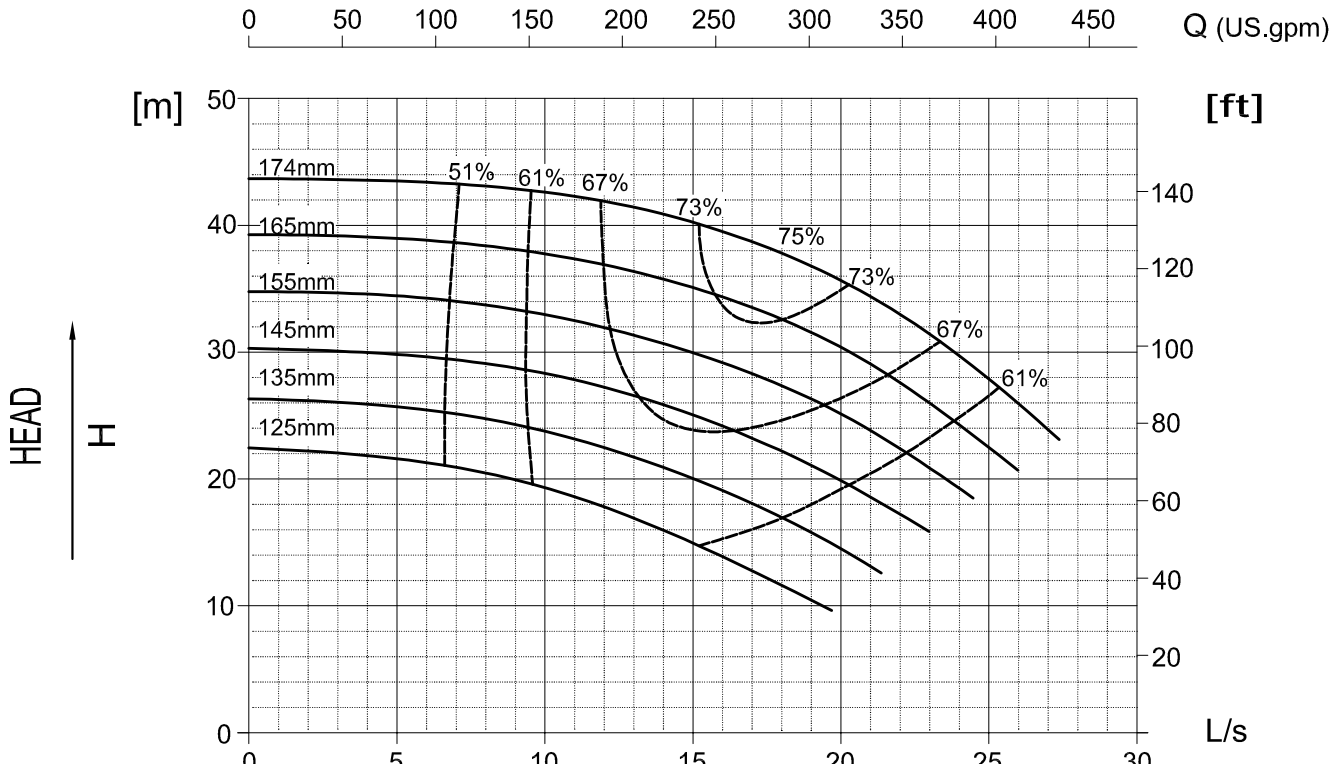

ISO9906-II, Date refers to clean cold water

65-50-200

Performance Curve

2900 rpm

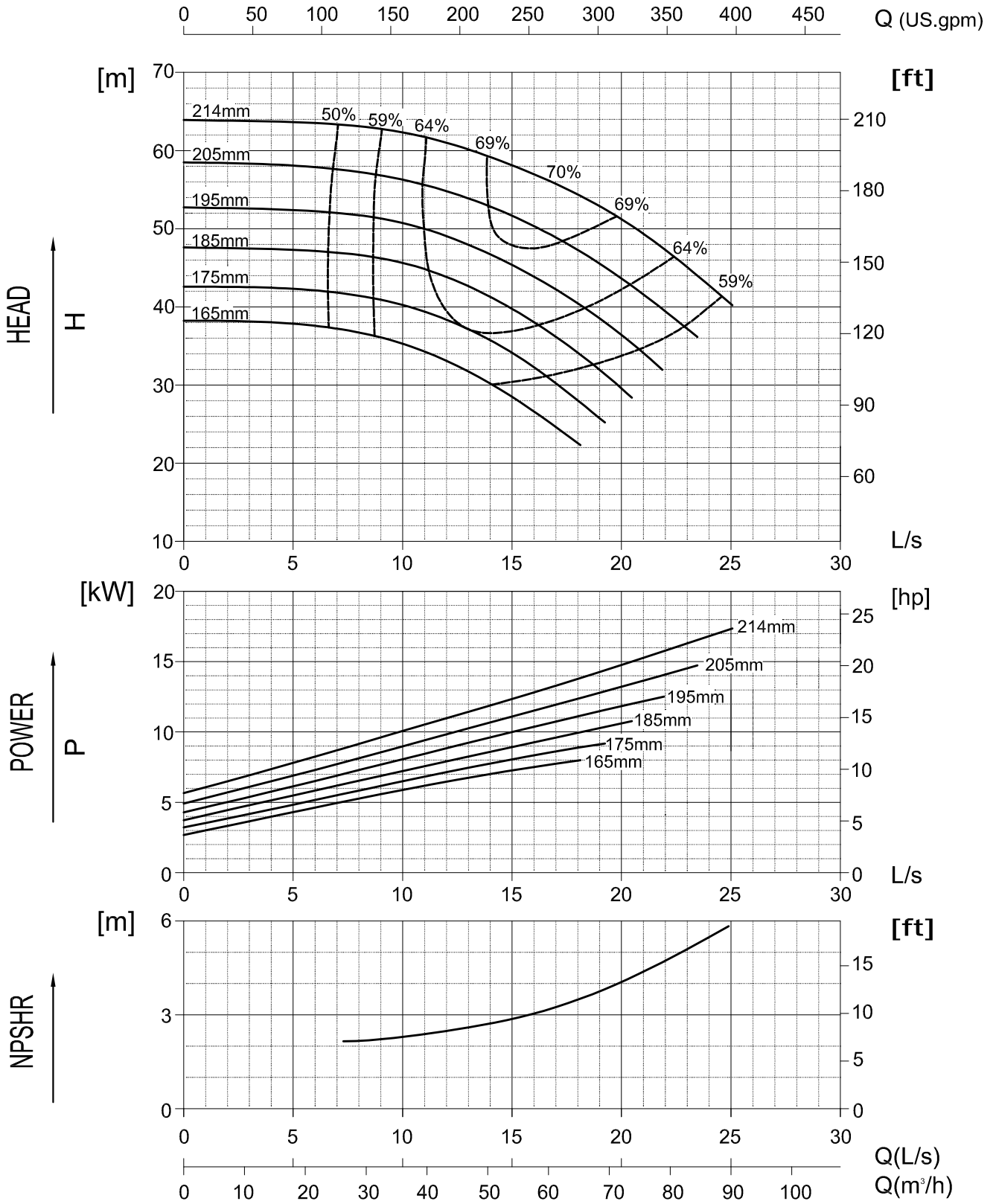

ISO9906-II, Date refers to clean cold water

65-50-260H

Performance Curve

2900 rpm

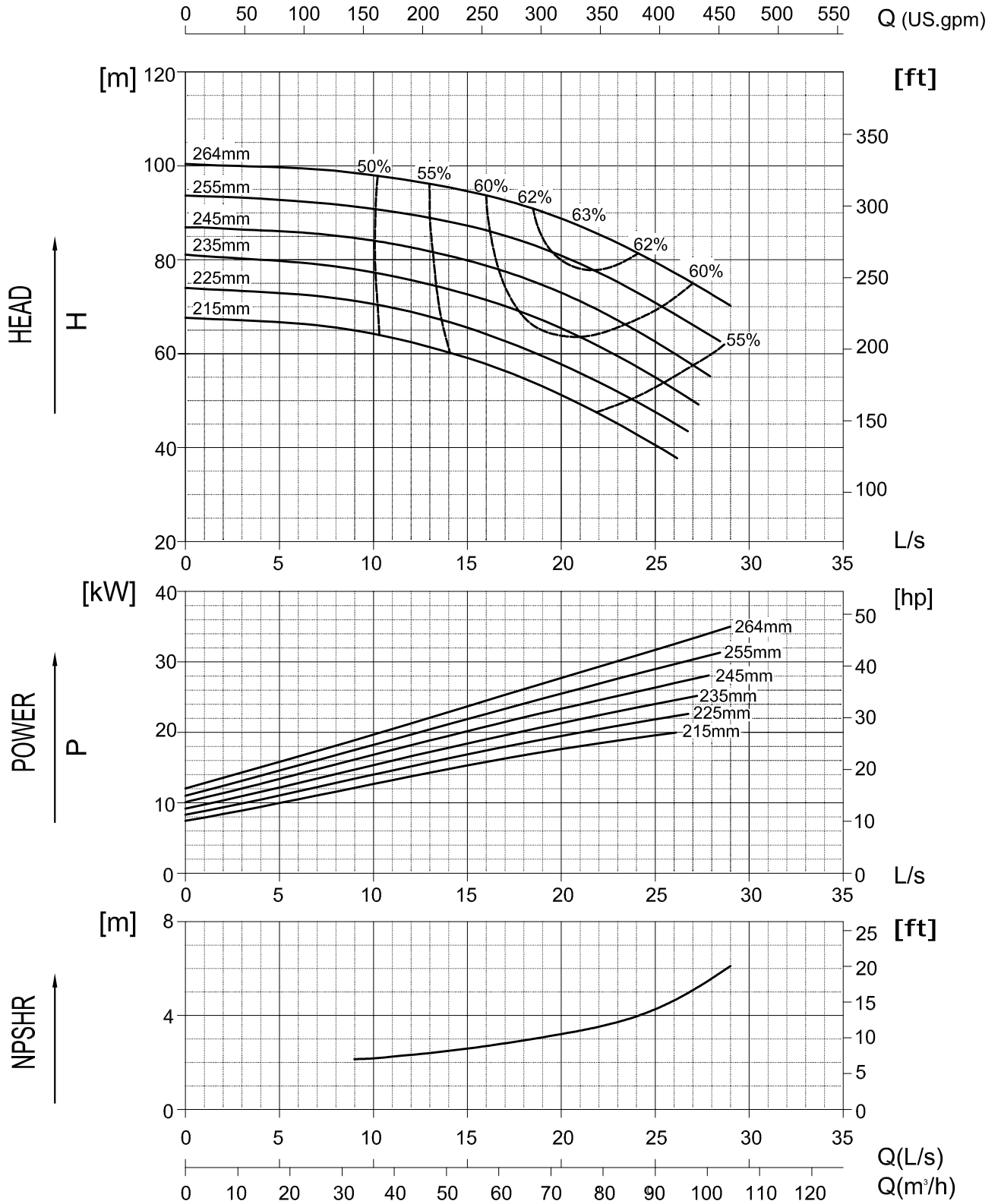

ISO9906-II, Date refers to clean cold water

65-50-320H

Performance Curve

2900 rpm

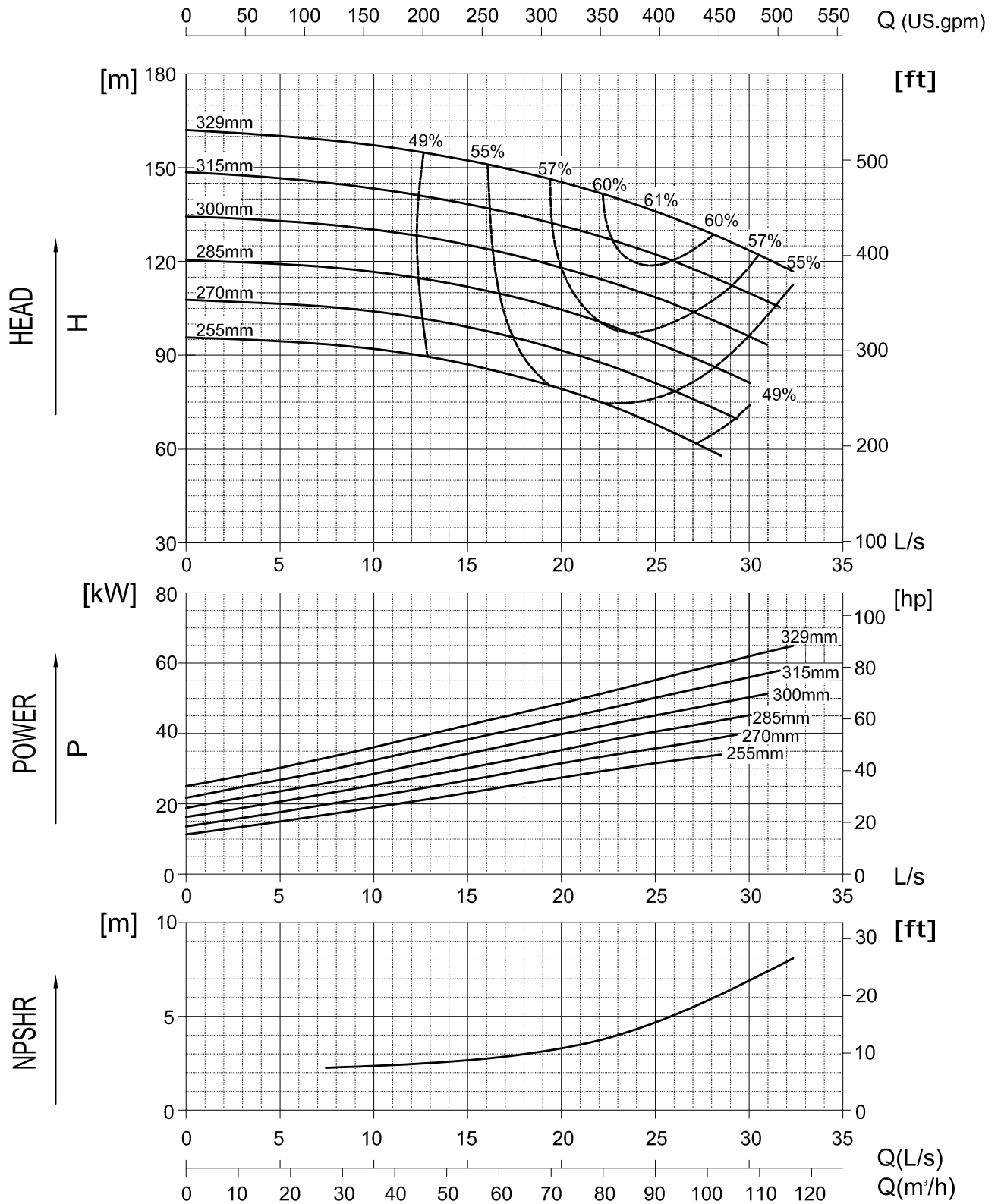

ISO9906-II, Date refers to clean cold water

80-65-130

Performance Curve

2900 rpm

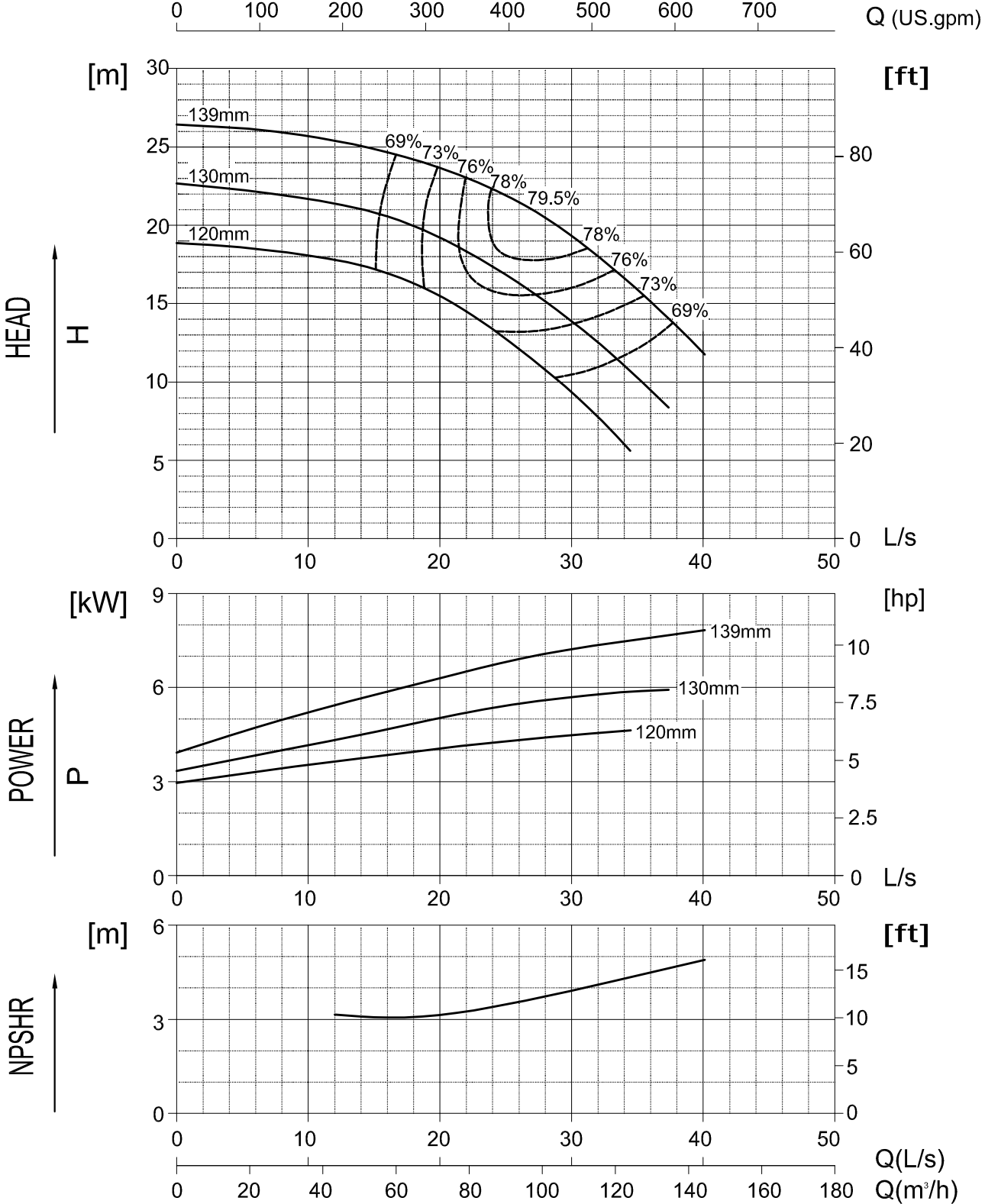

ISO9906-II, Date refers to clean cold water

80-65-160

Performance Curve

2900 rpm

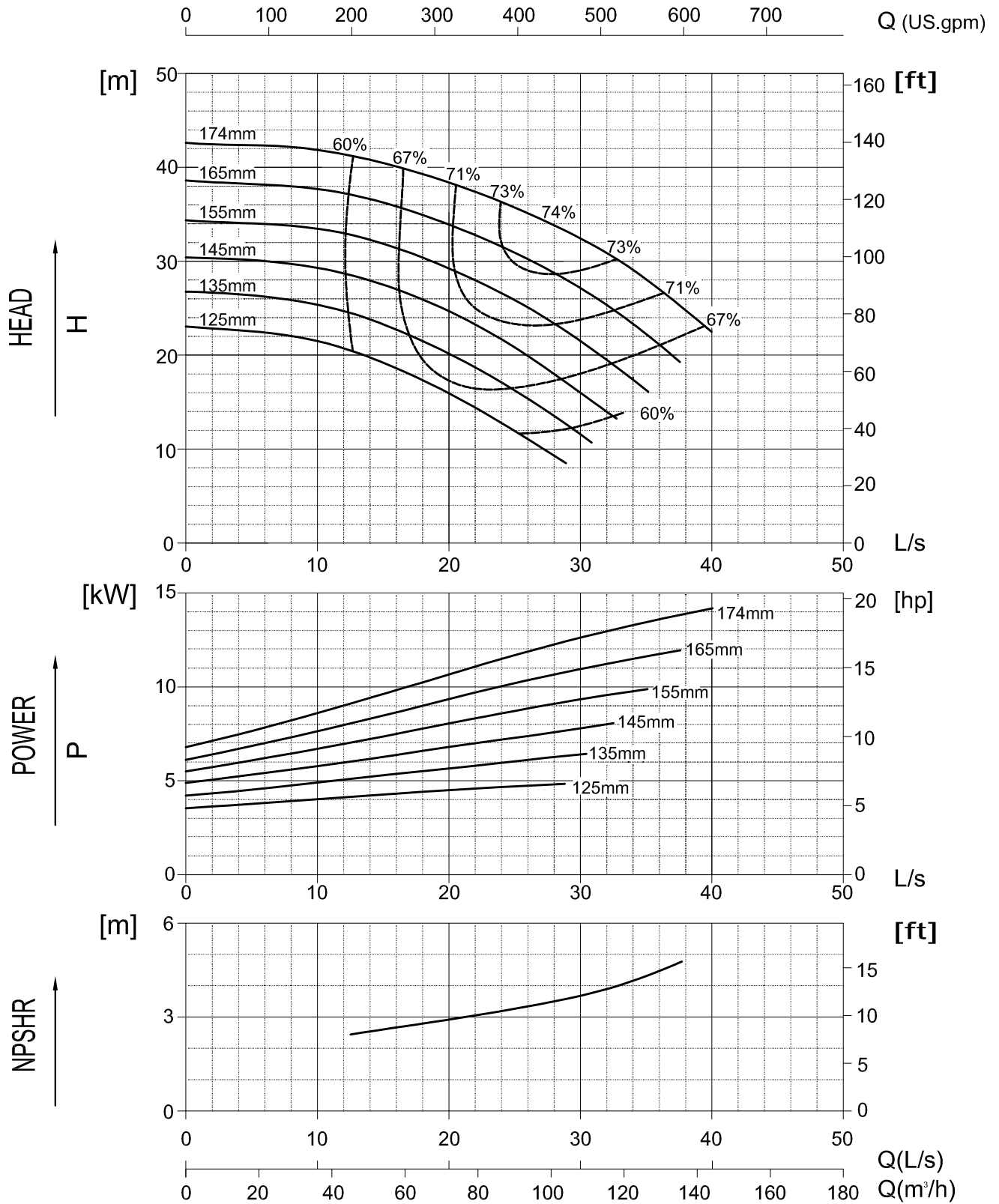

ISO9906-II, Date refers to clean cold water

80-65-200H

Performance Curve

2900 rpm

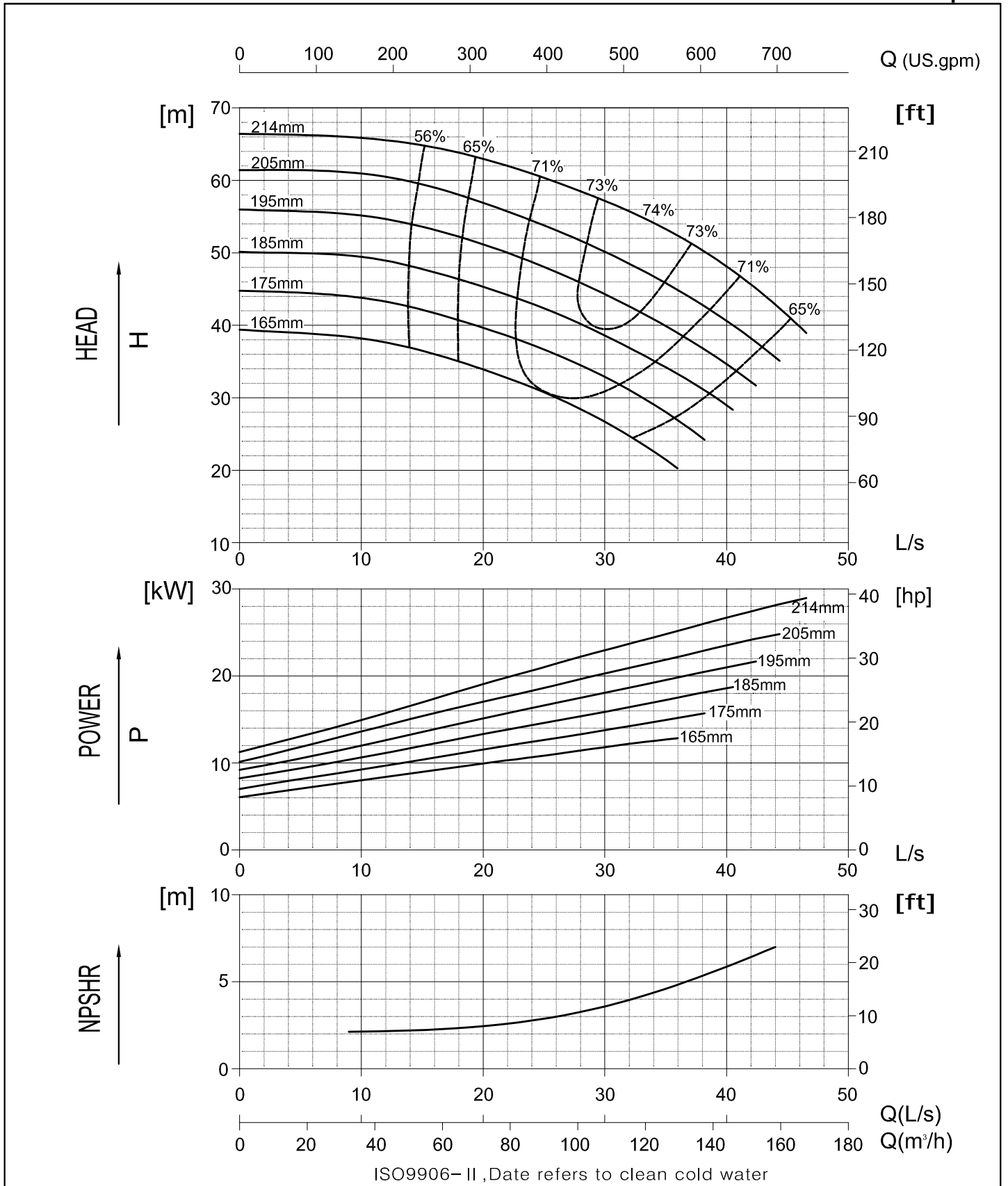

80-65-260

Performance Curve

2900 rpm

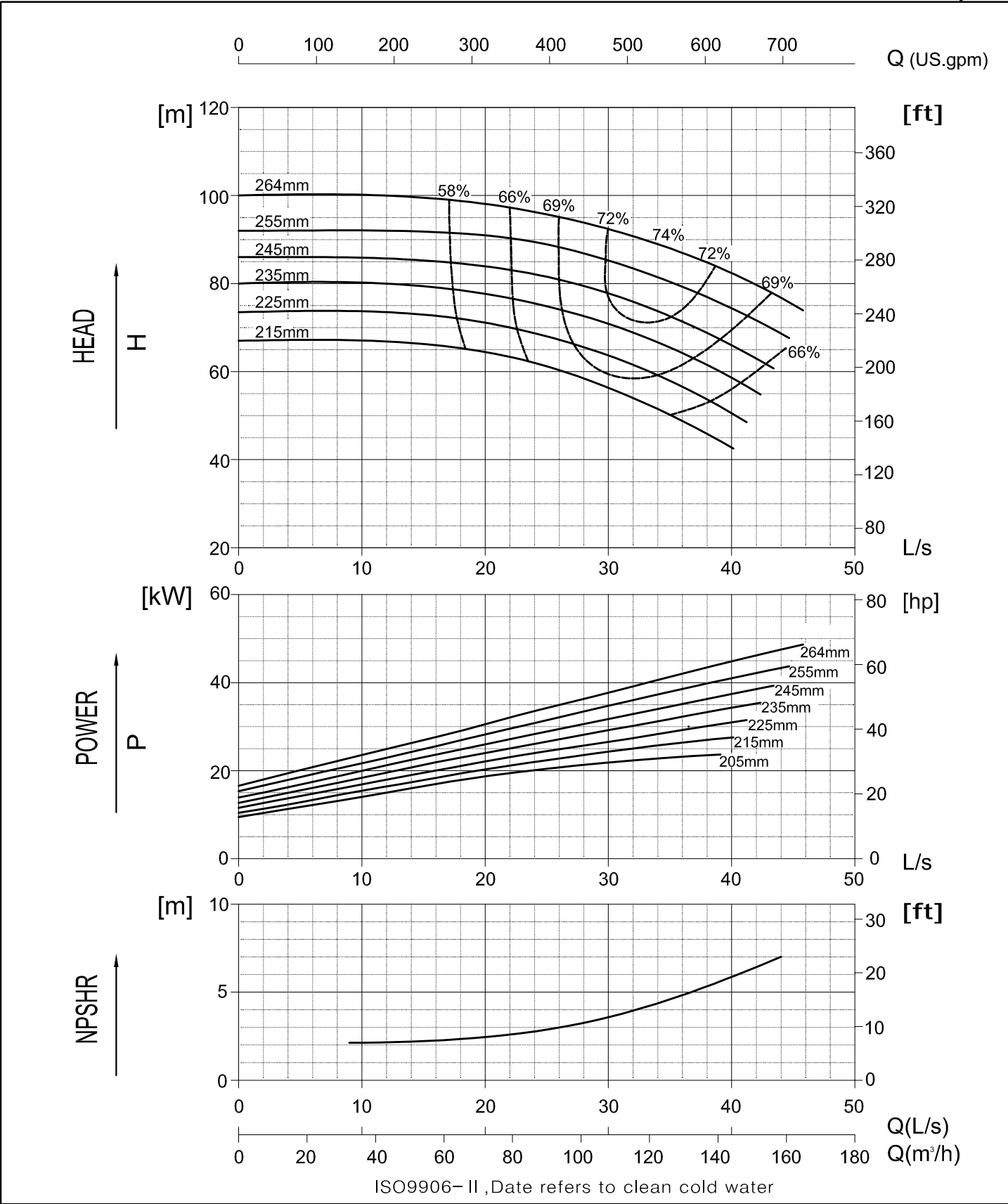

80-65-320H

Performance Curve

2900 rpm

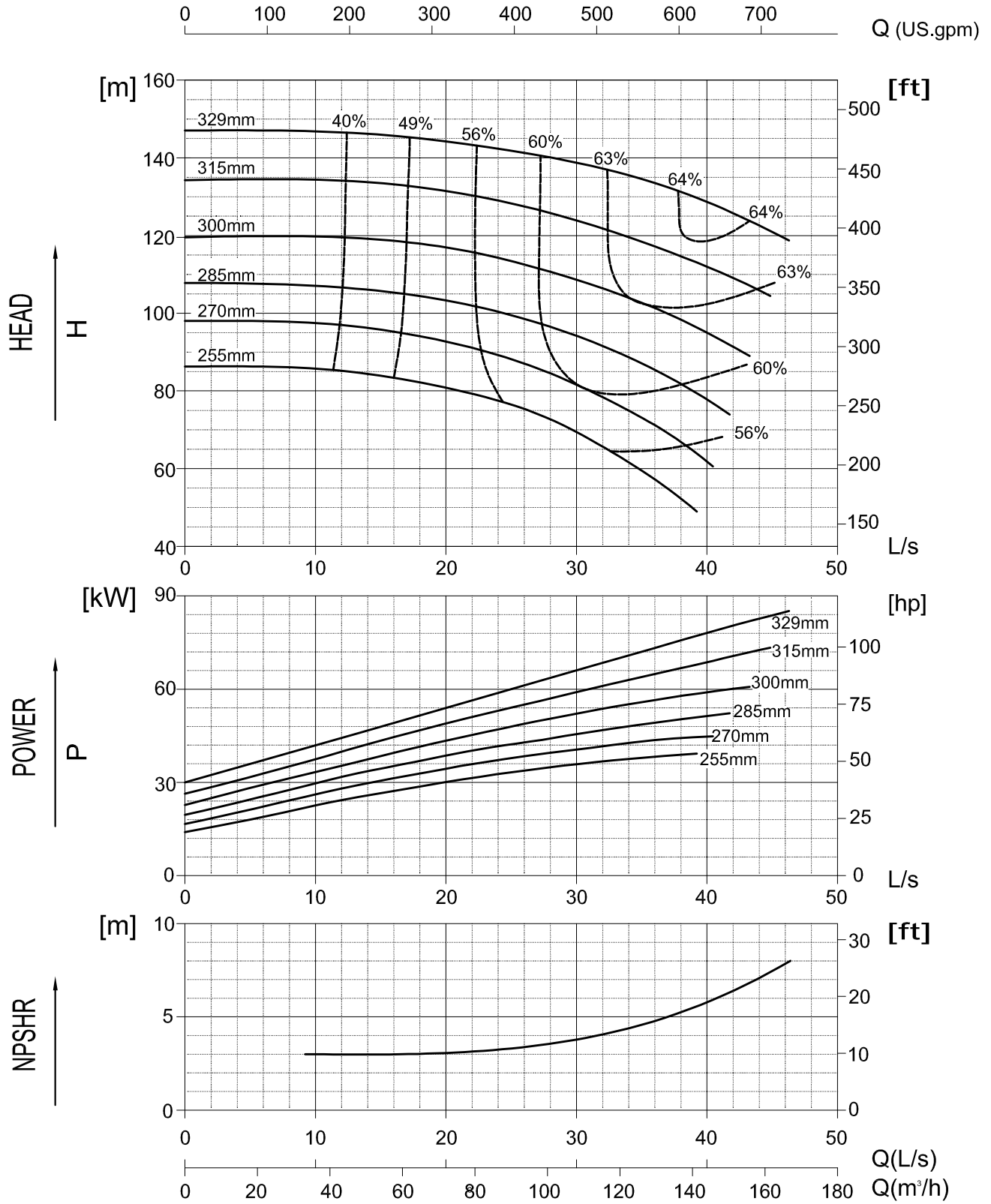

ISO9906-II, Date refers to clean cold water

100-80-160

Performance Curve

2900 rpm

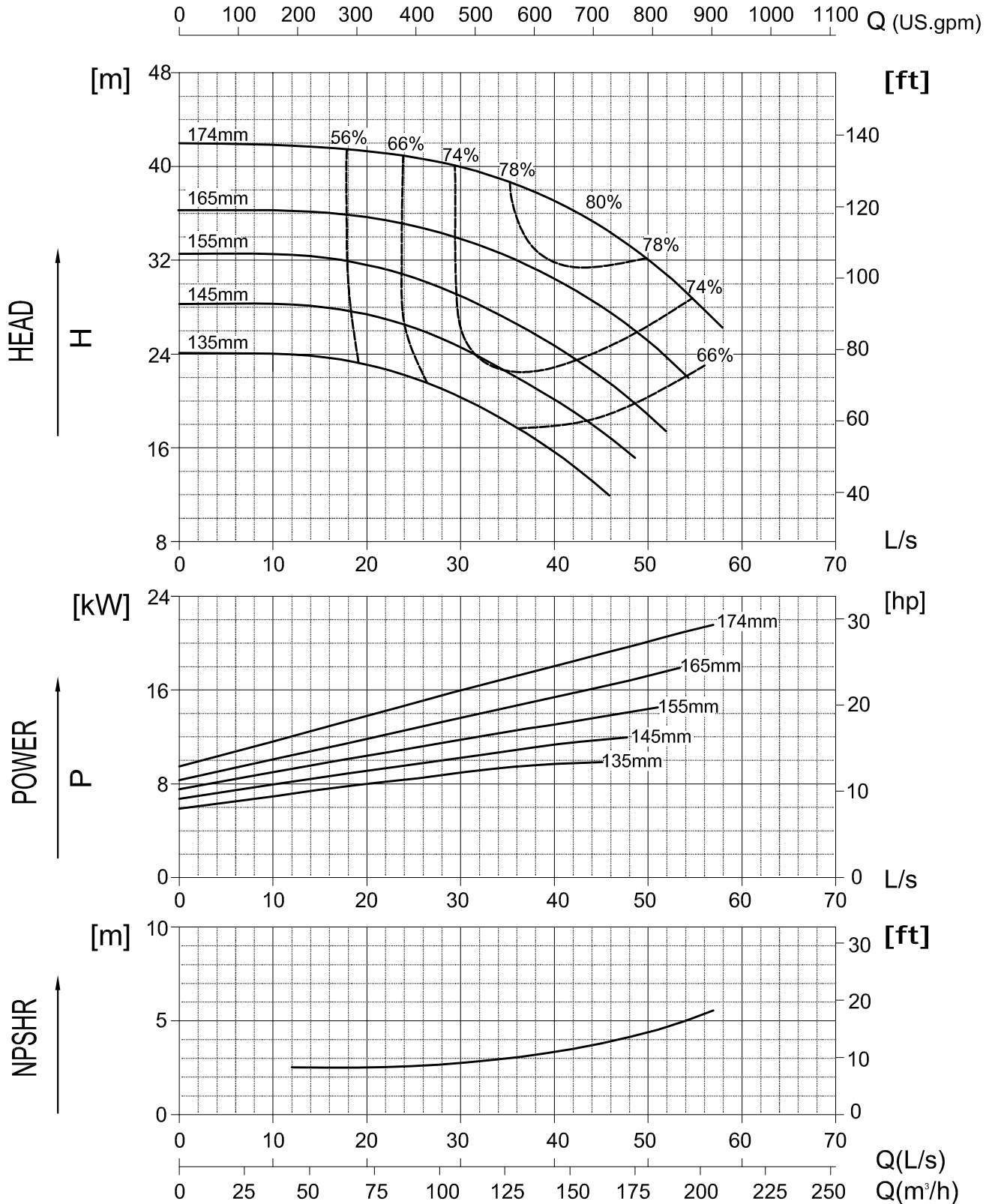

ISO9906-II, Date refers to clean cold water

100-80-200

Performance Curve

2900 rpm

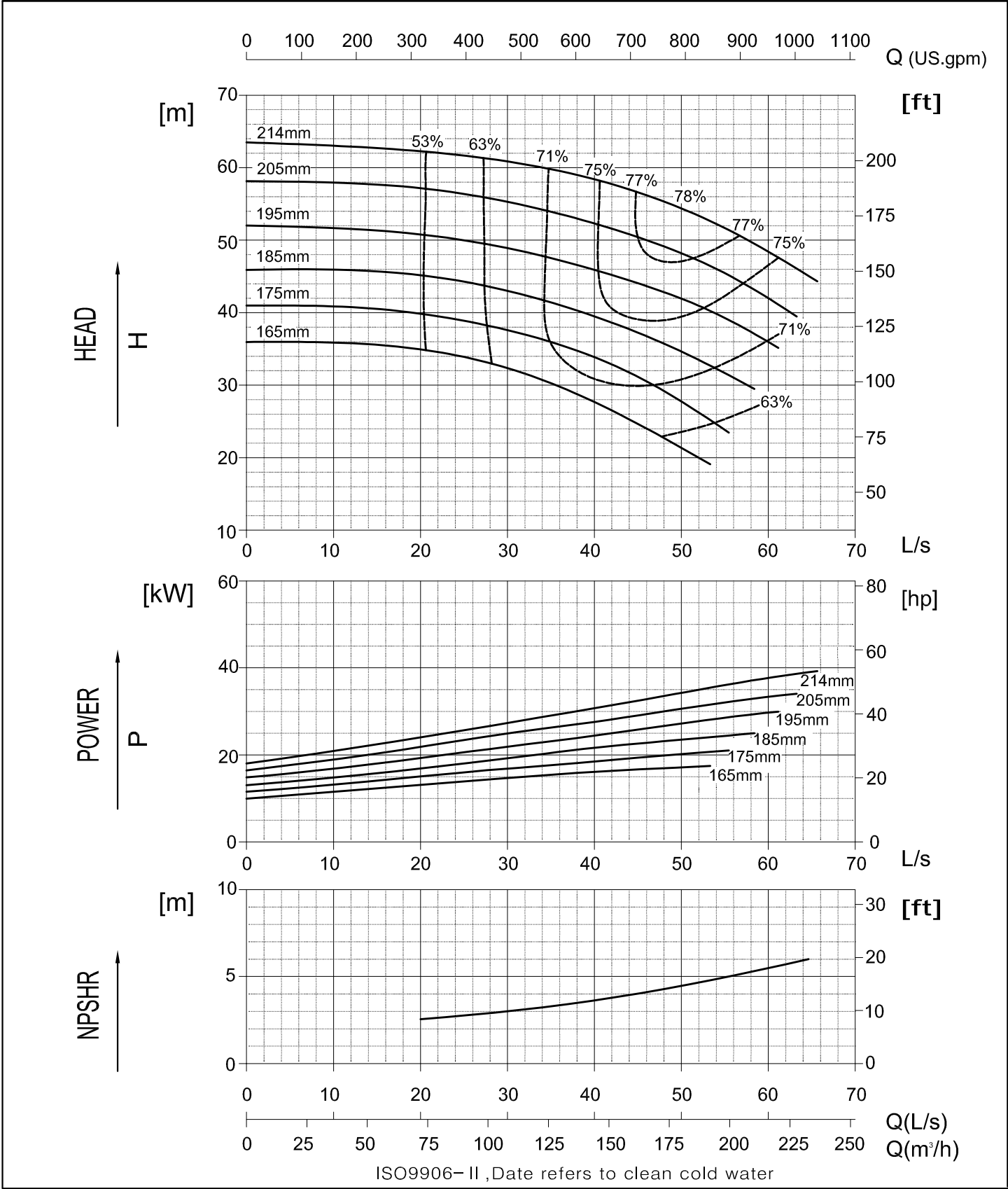

100-80-260

Performance Curve

2900 rpm

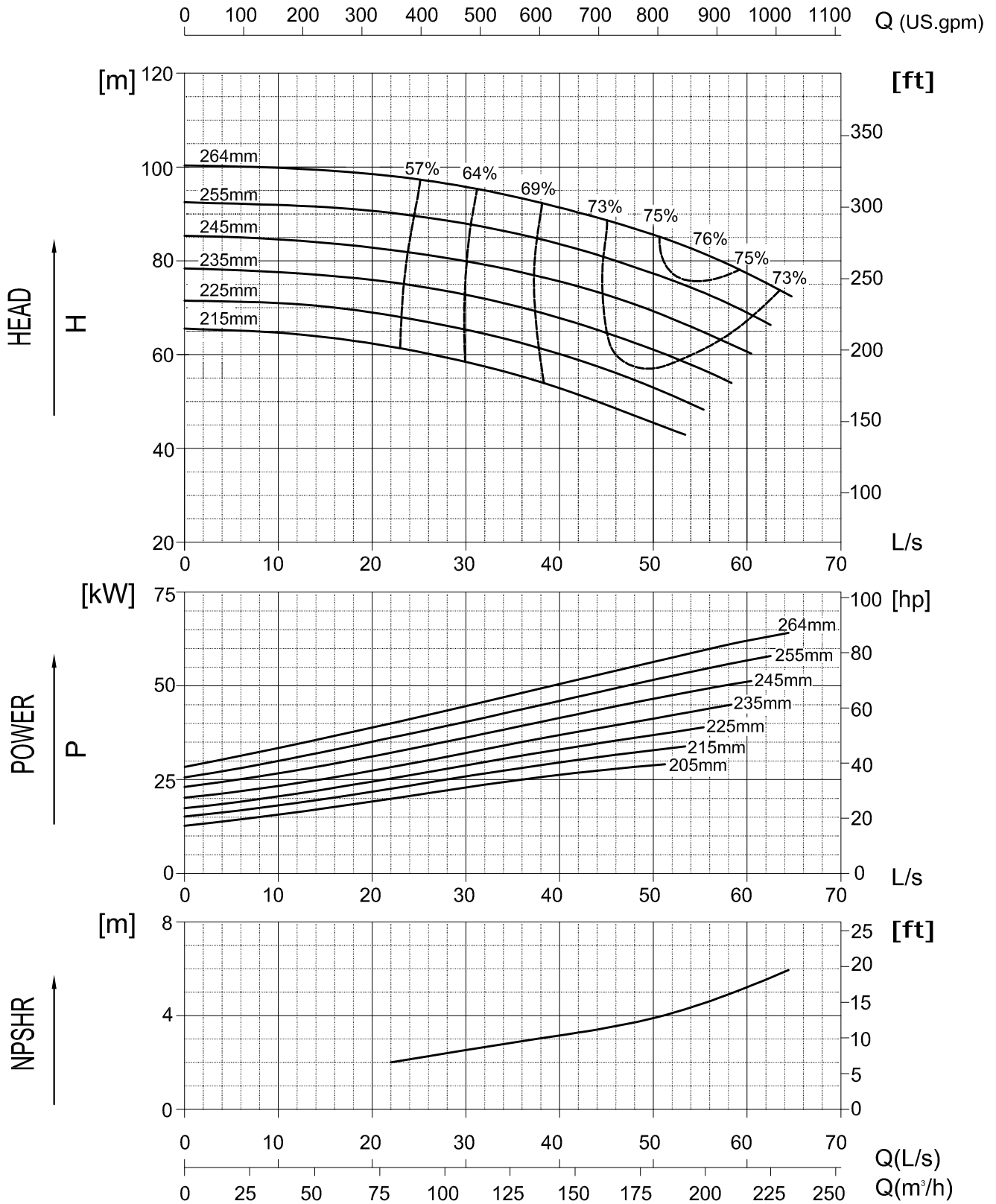

ISO9906-II, Date refers to clean cold water

100-80-320H

Performance Curve

2900 rpm

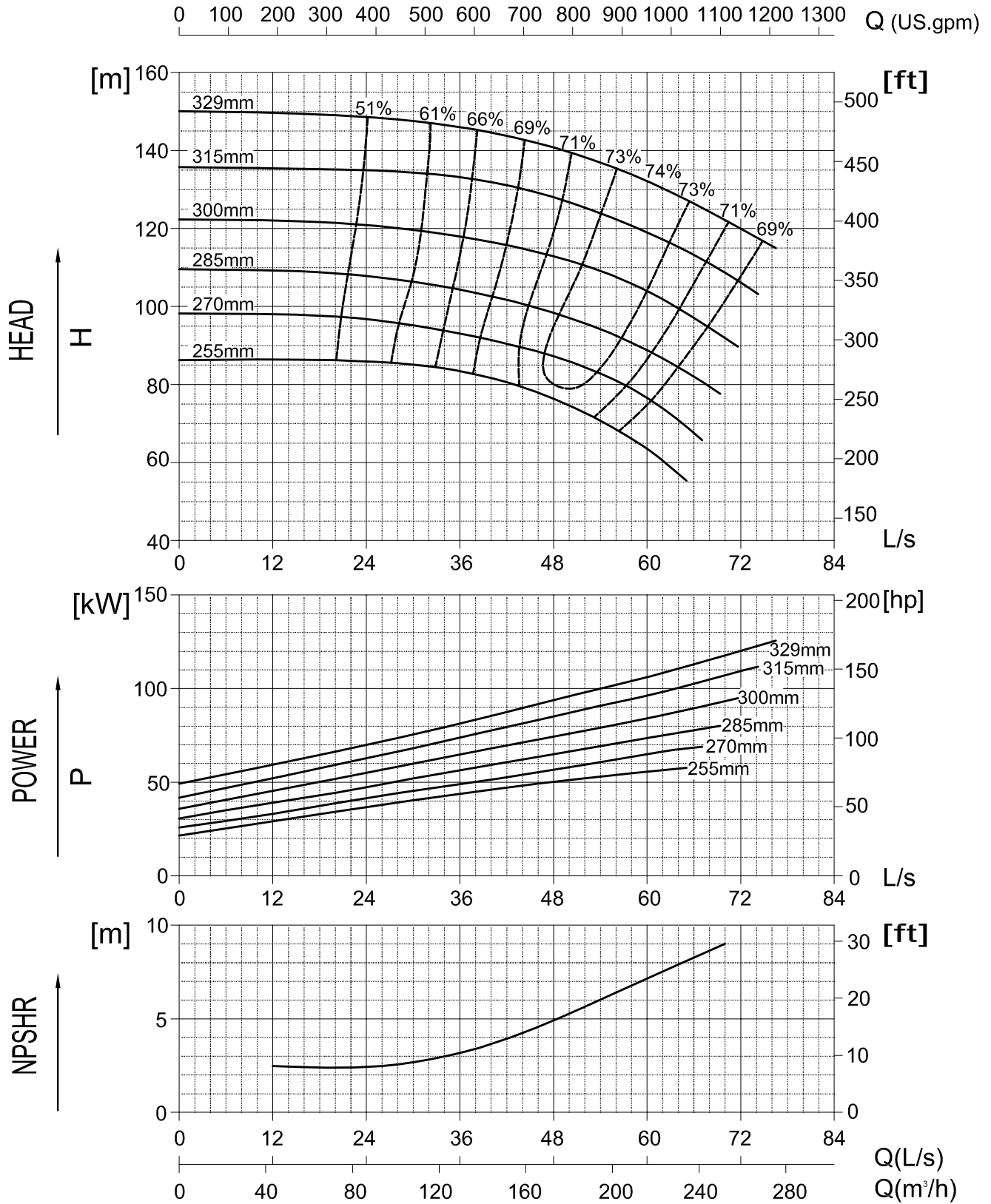

ISO9906-II, Date refers to clean cold water

125-100-160

Performance Curve

2900 rpm

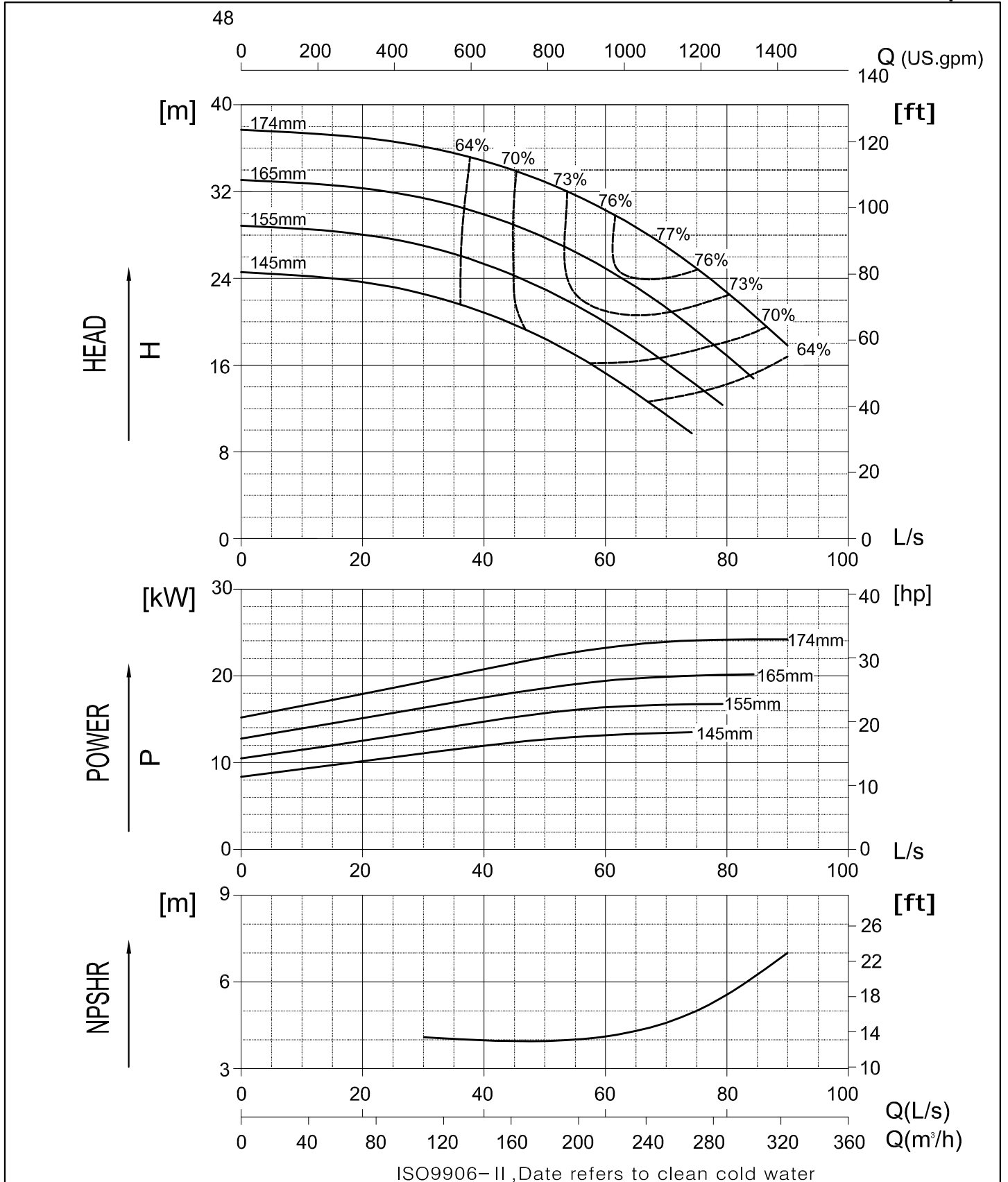

ISO9906-II, Date refers to clean cold water

125-100-200

Performance Curve

2900 rpm

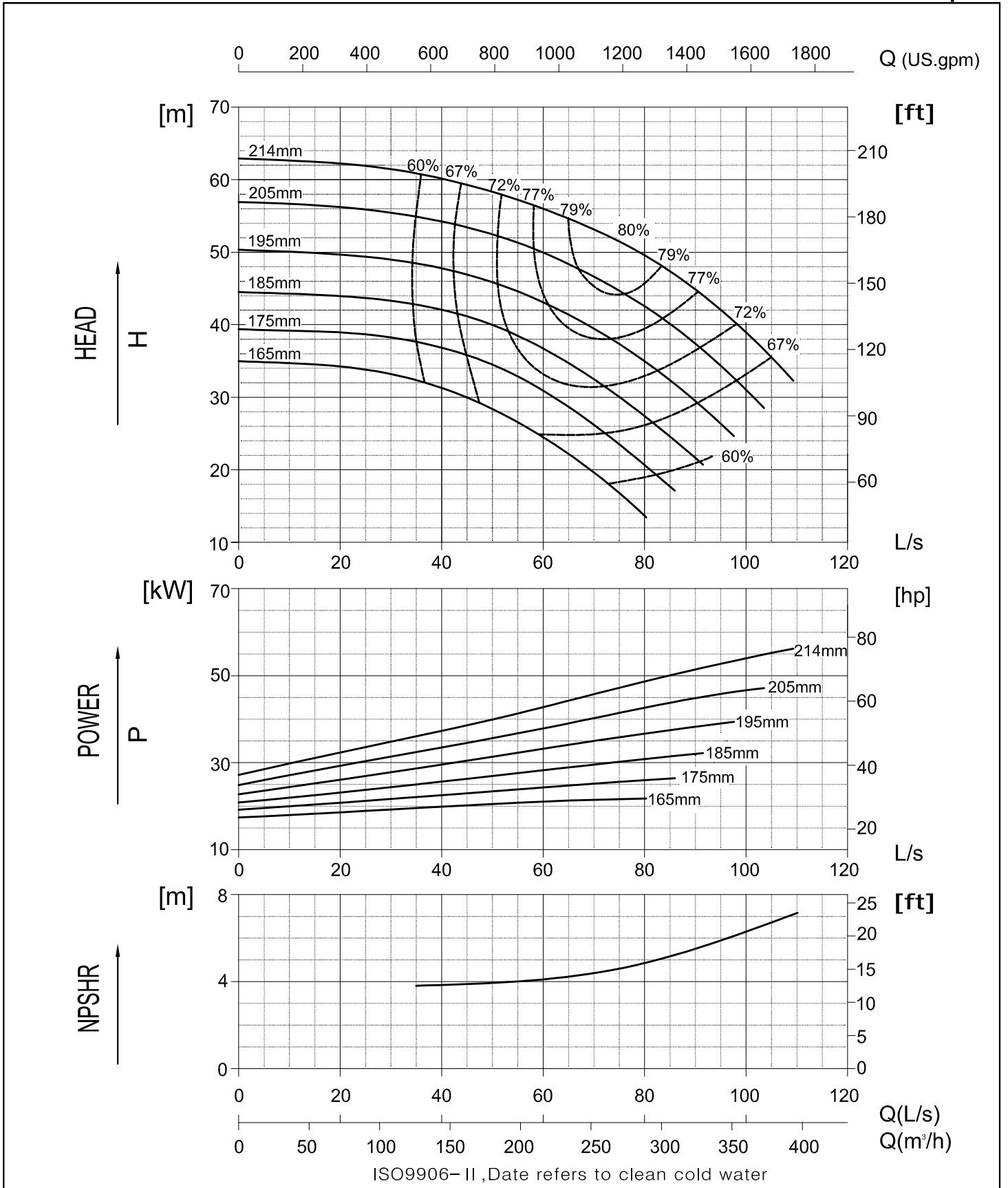

125-100-260H

Performance Curve

2900 rpm

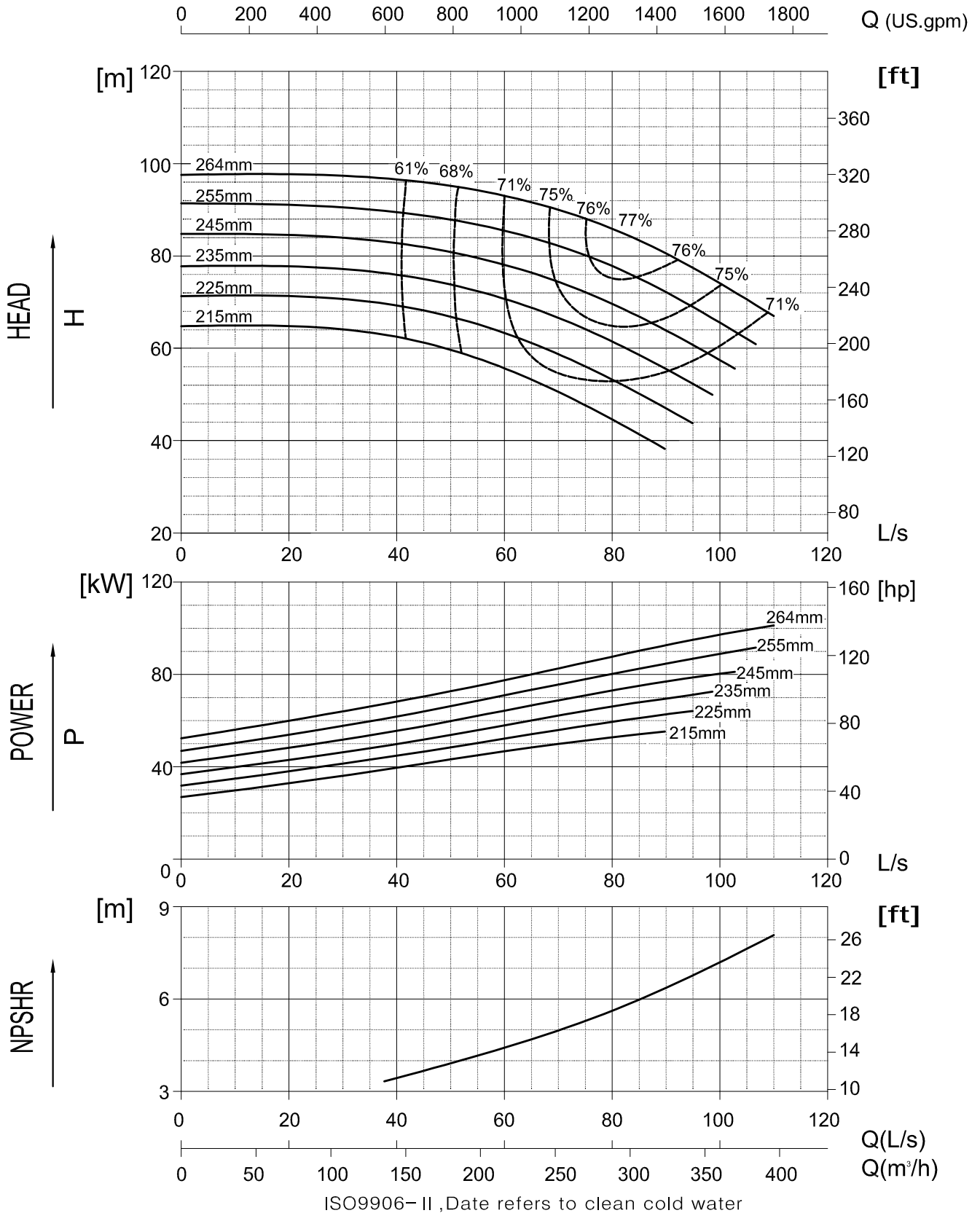

125-100-320H

Performance Curve

2900 rpm

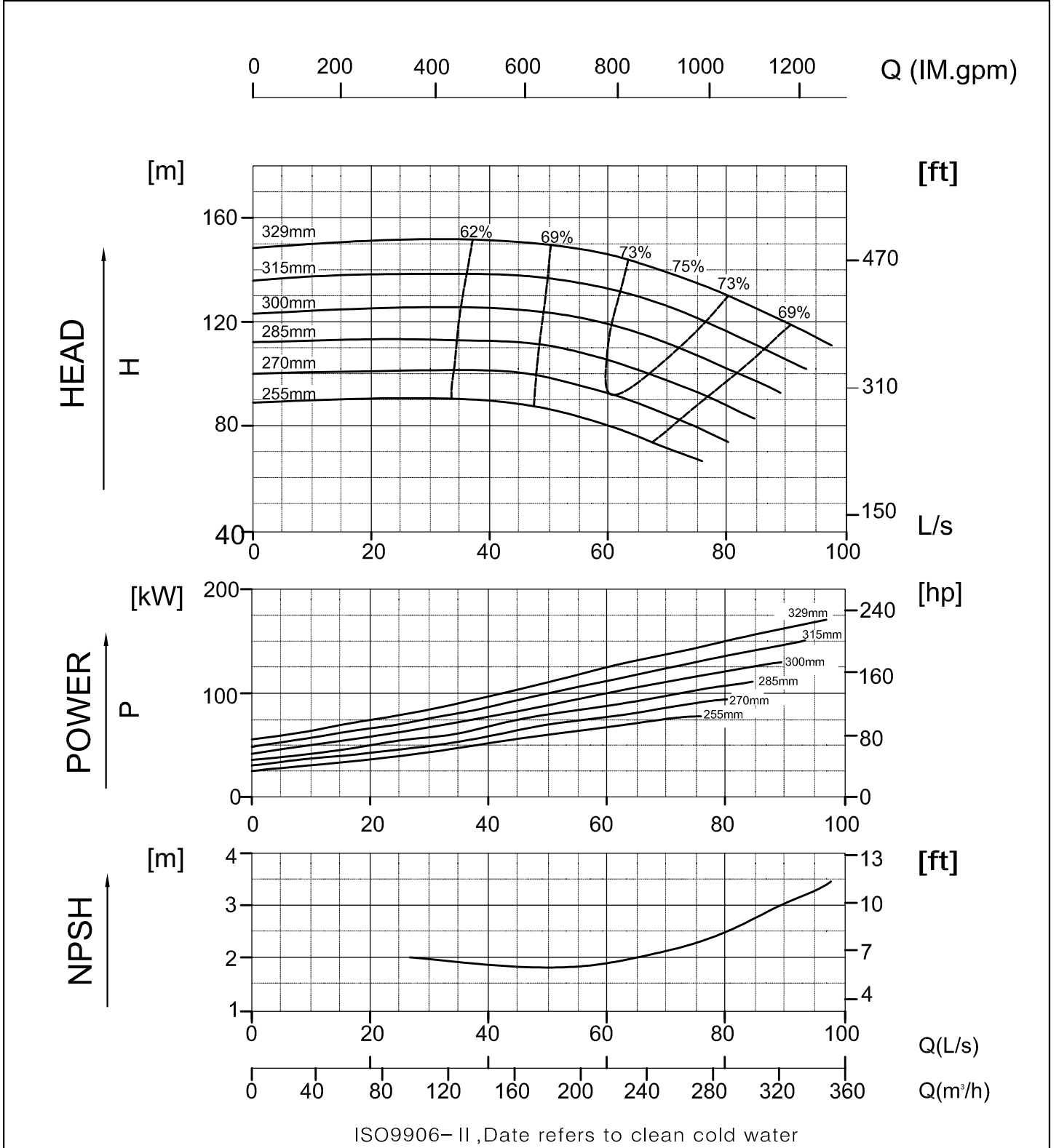

ISO9906-II, Date refers to clean cold water

150-125-200

Performance Curve

2900 rpm

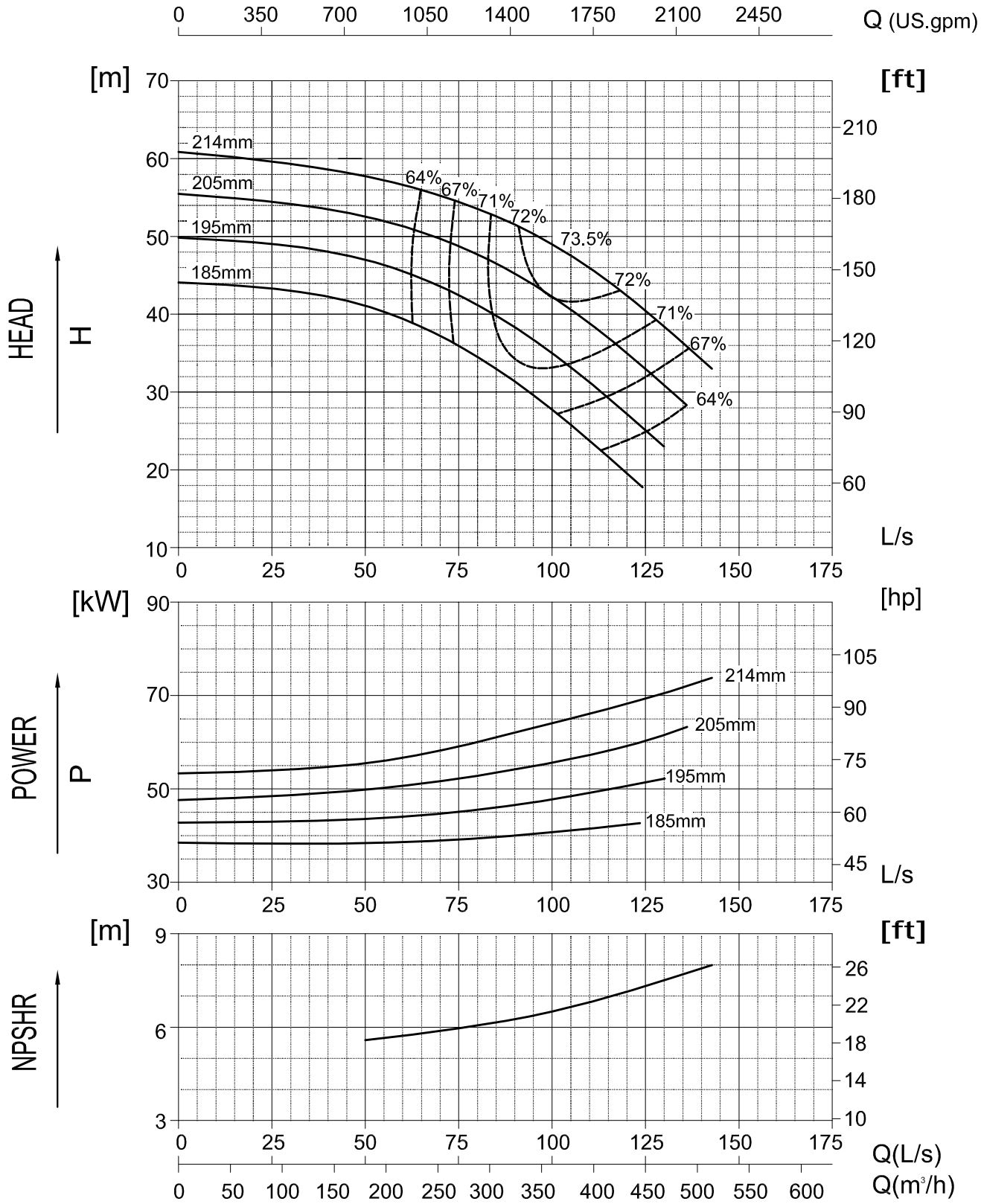

ISO9906-II, Date refers to clean cold water

150-125-260H Performance Curve 2900 rpm

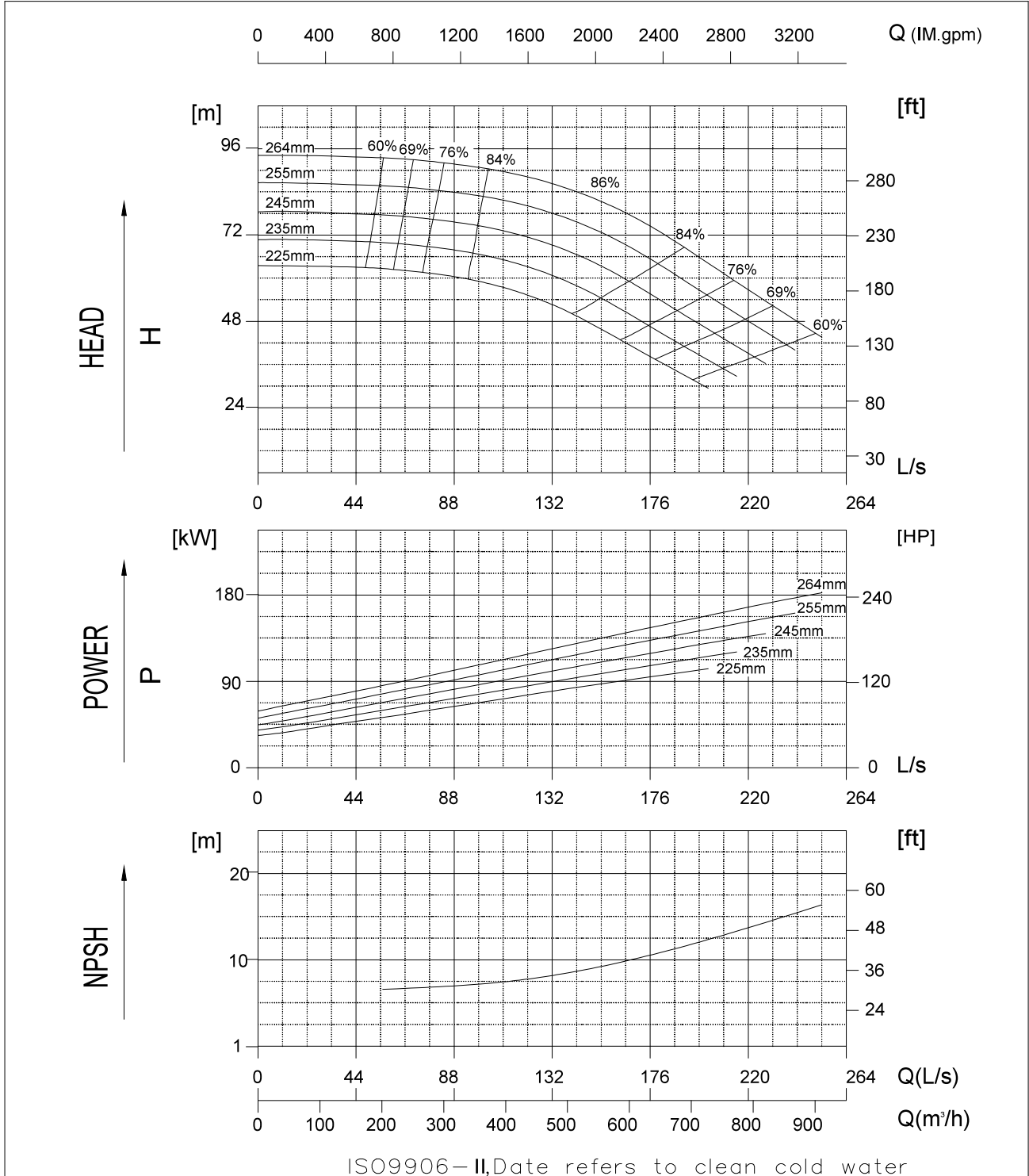

50-32-130

Performance Curve

1450 rpm

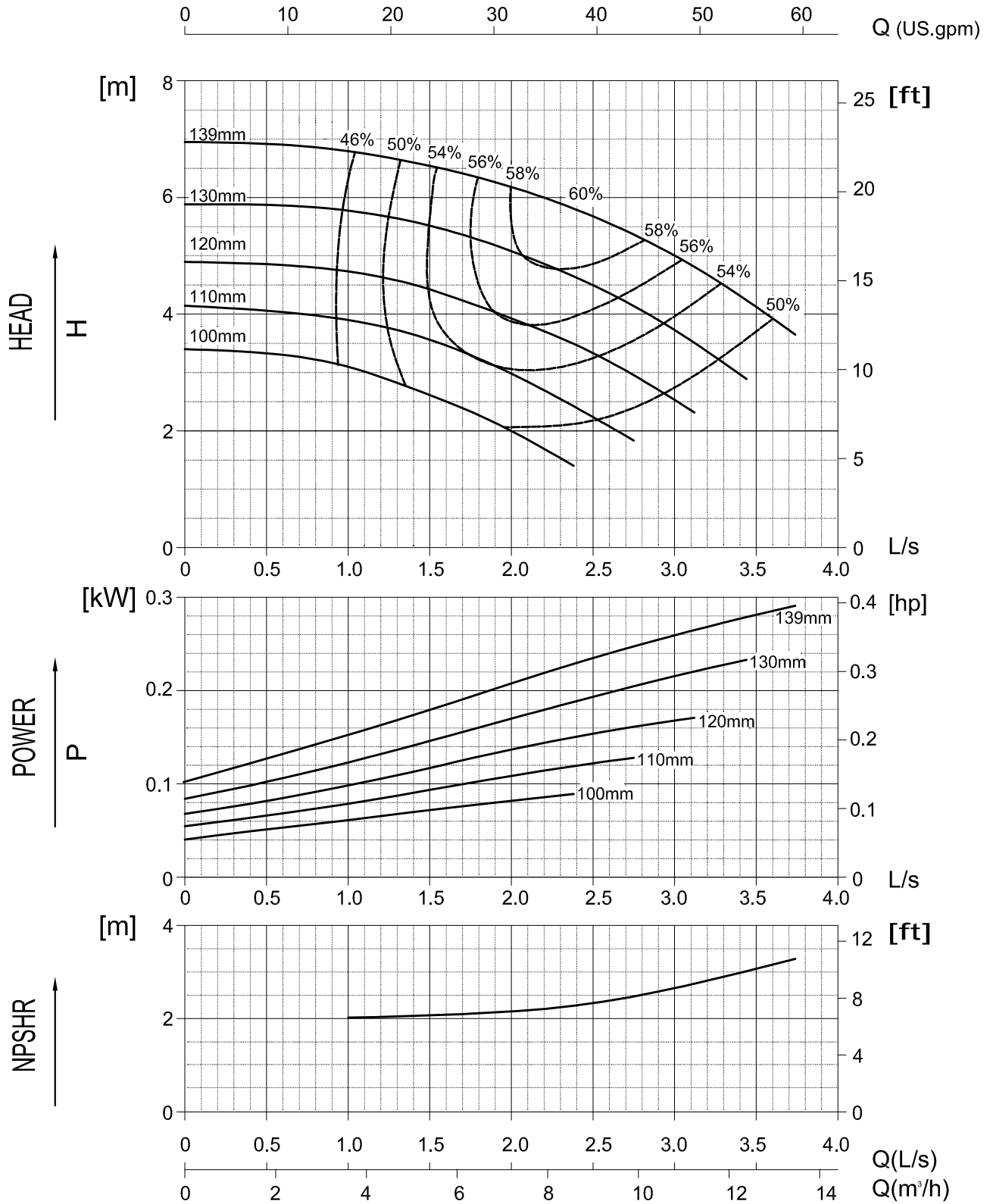

ISO9906-II, Date refers to clean cold water

50-32-160

Performance Curve

1450 rpm

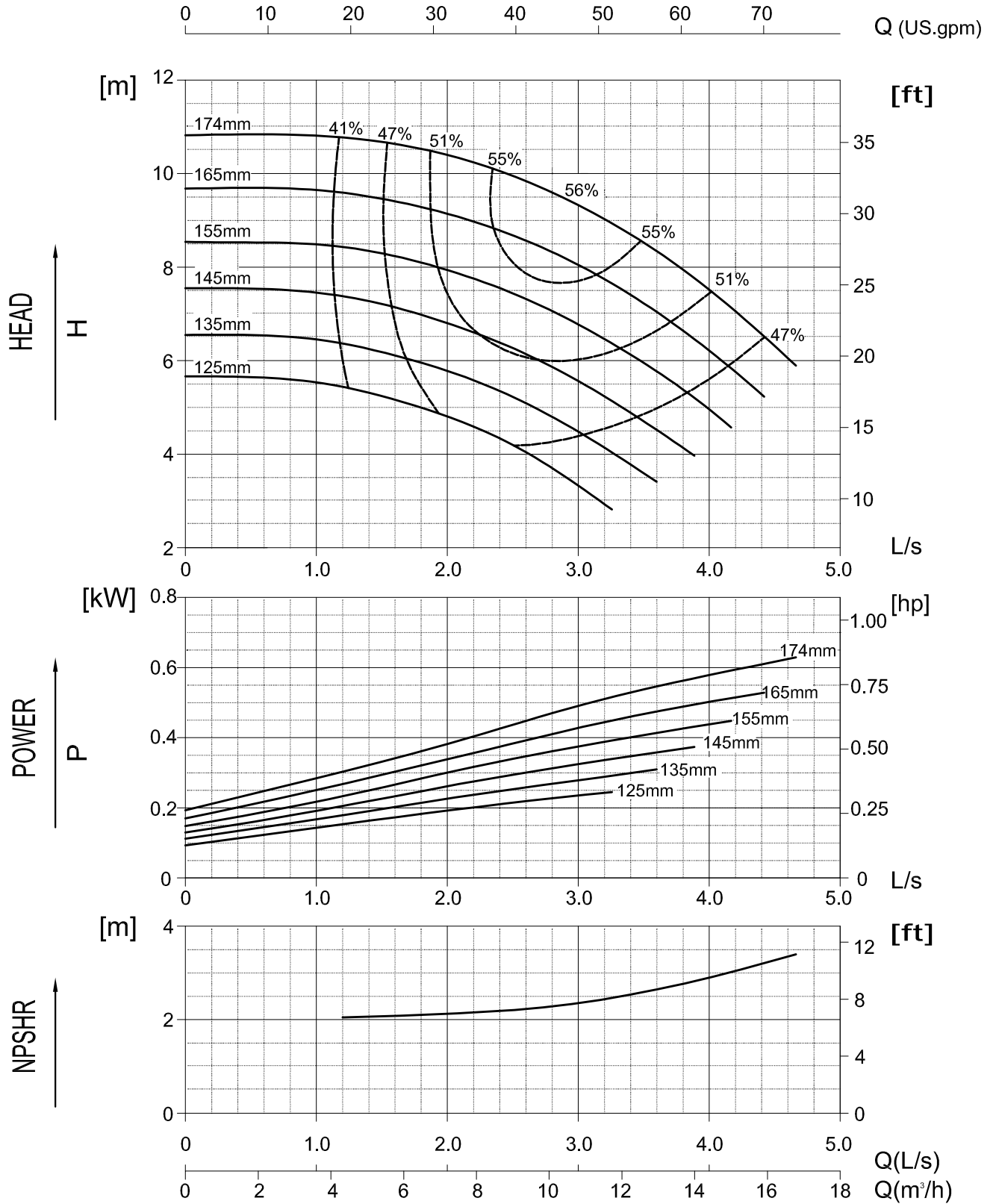

ISO9906-II, Date refers to clean cold water

50-32-200

Performance Curve

1450 rpm

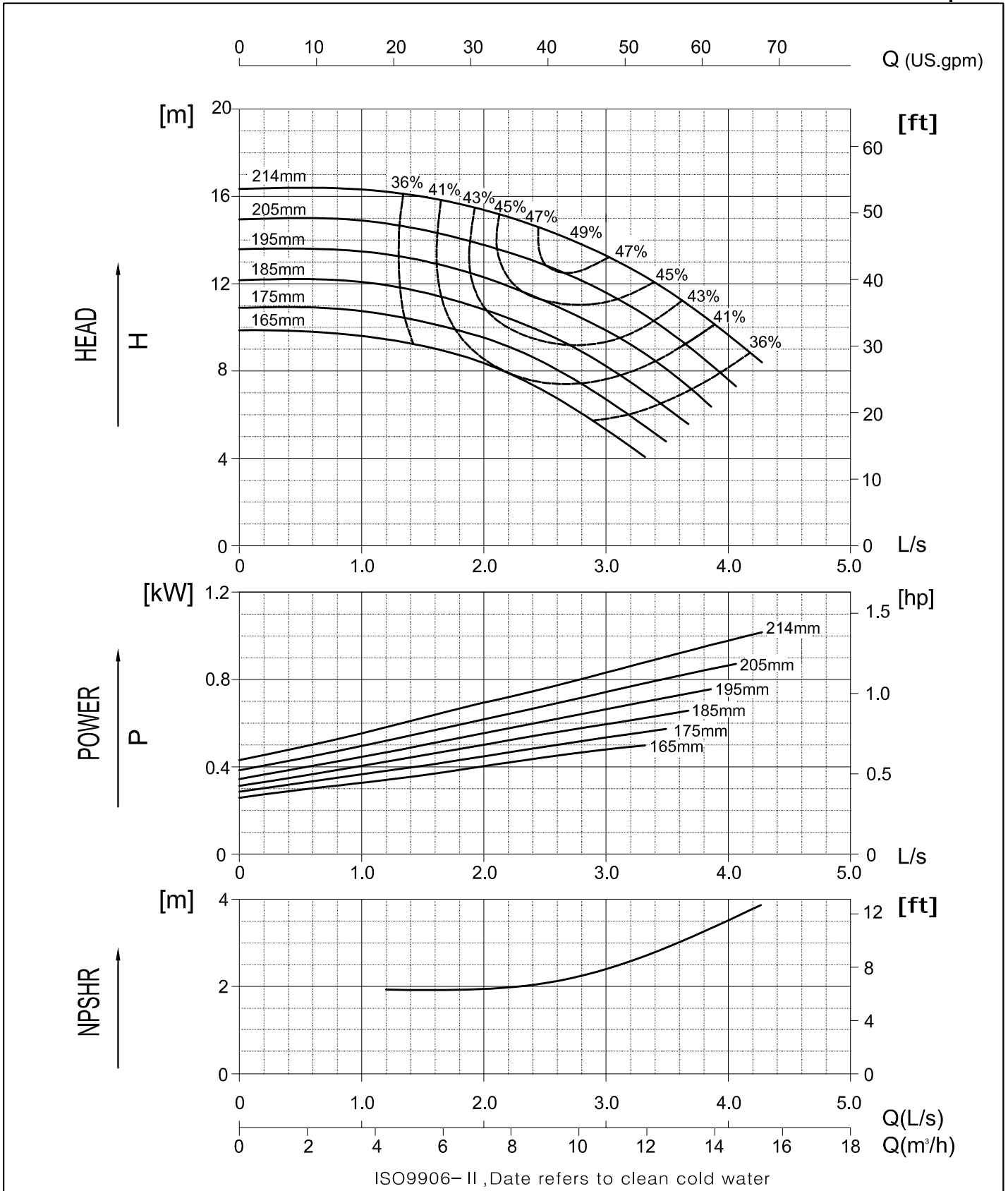

50-32-260

Performance Curve

1450 rpm

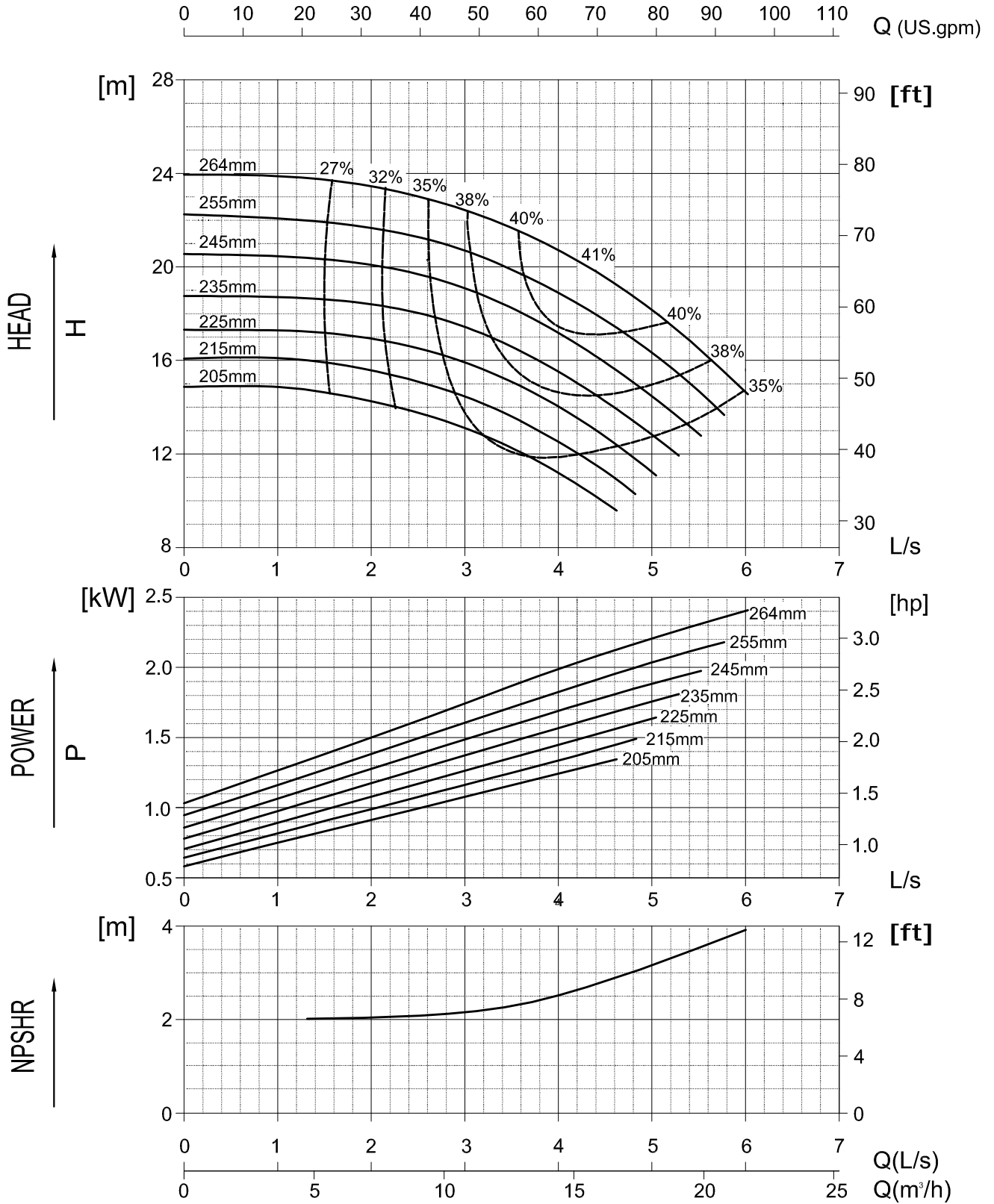

ISO9906-II, Date refers to clean cold water

65-40-130

Performance Curve

1450 rpm

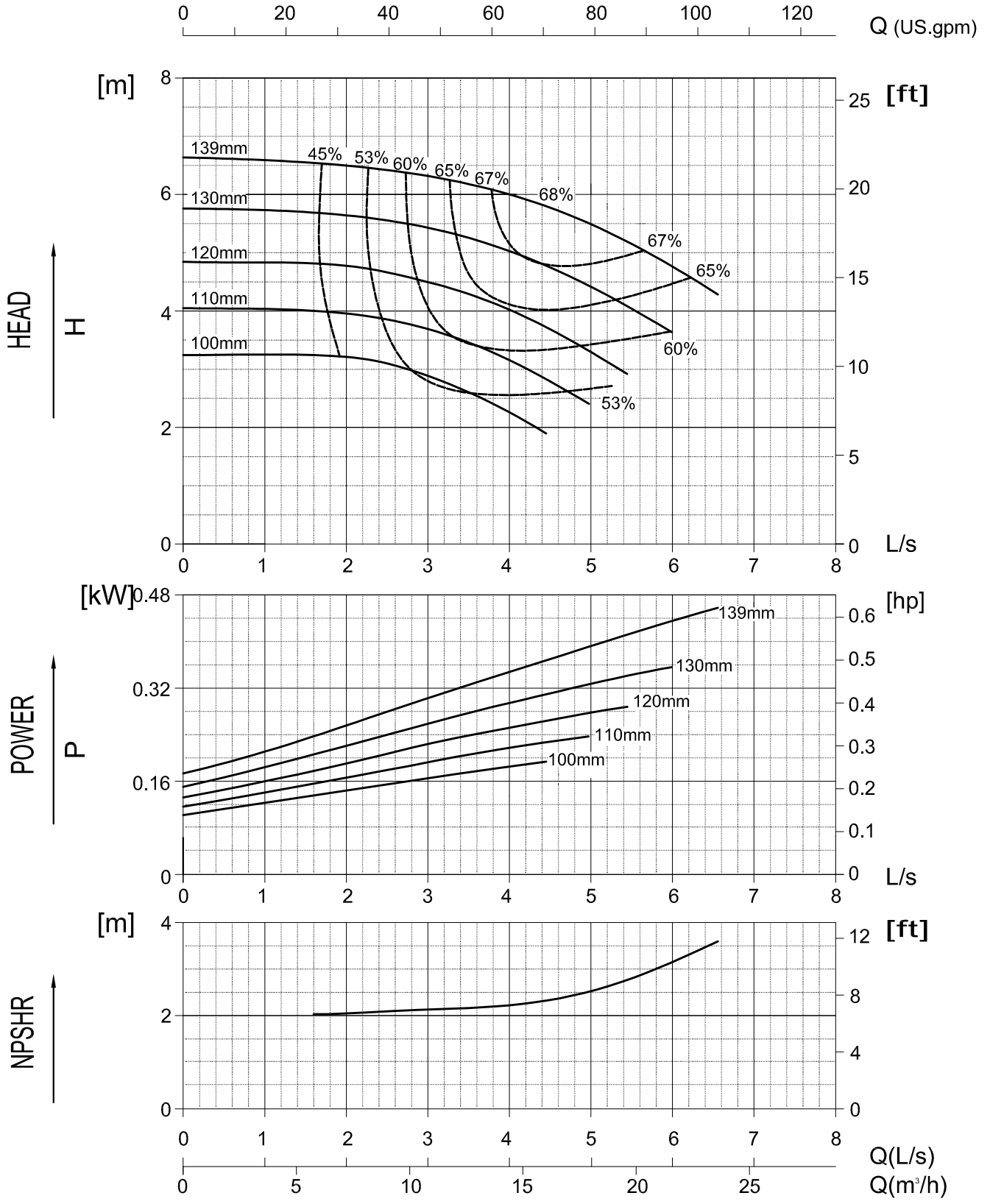

ISO9906-II, Date refers to clean cold water

65-40-160

Performance Curve

1450 rpm

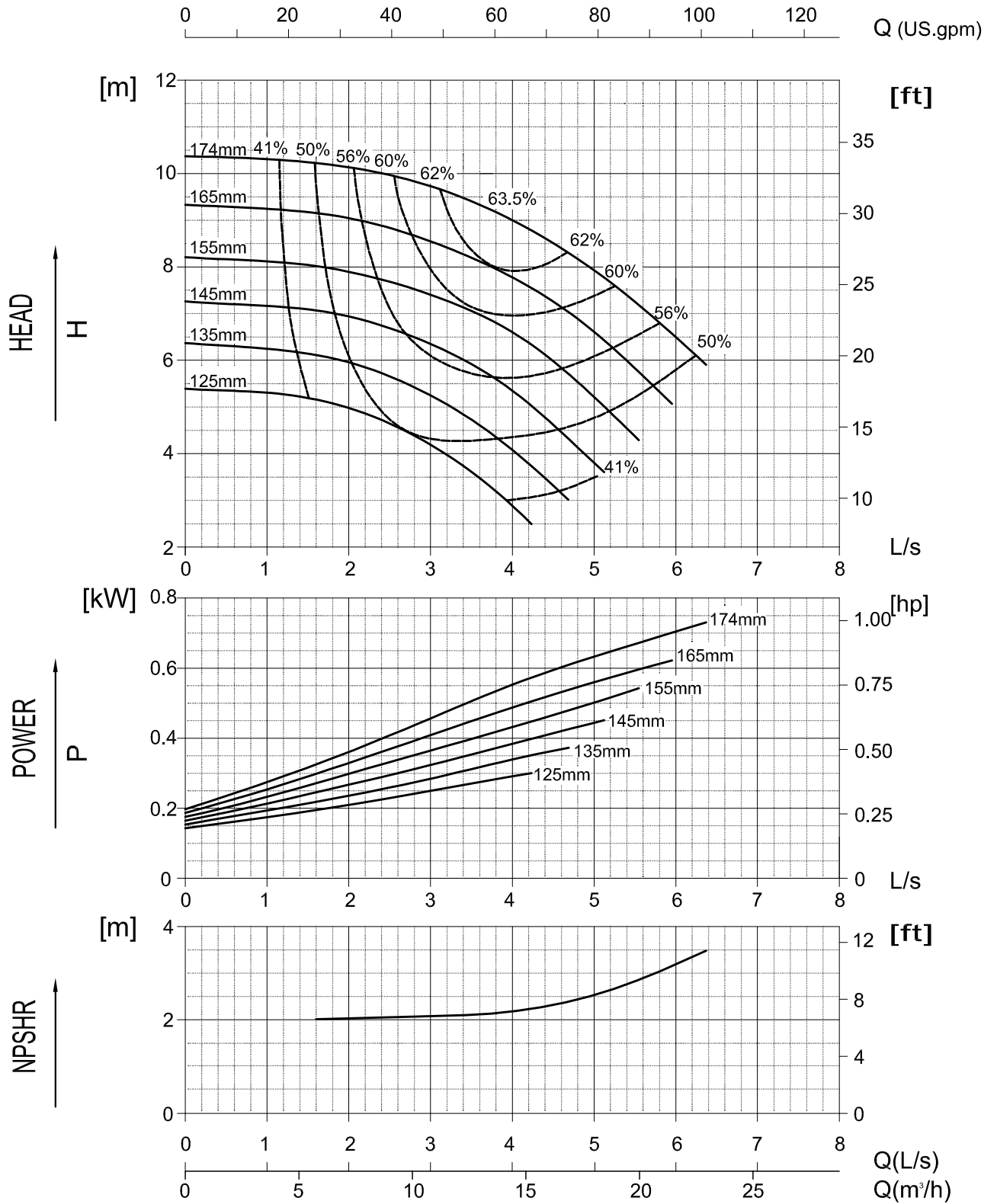

ISO9906- II , Date refers to clean cold water

65-40-200

Performance Curve

1450 rpm

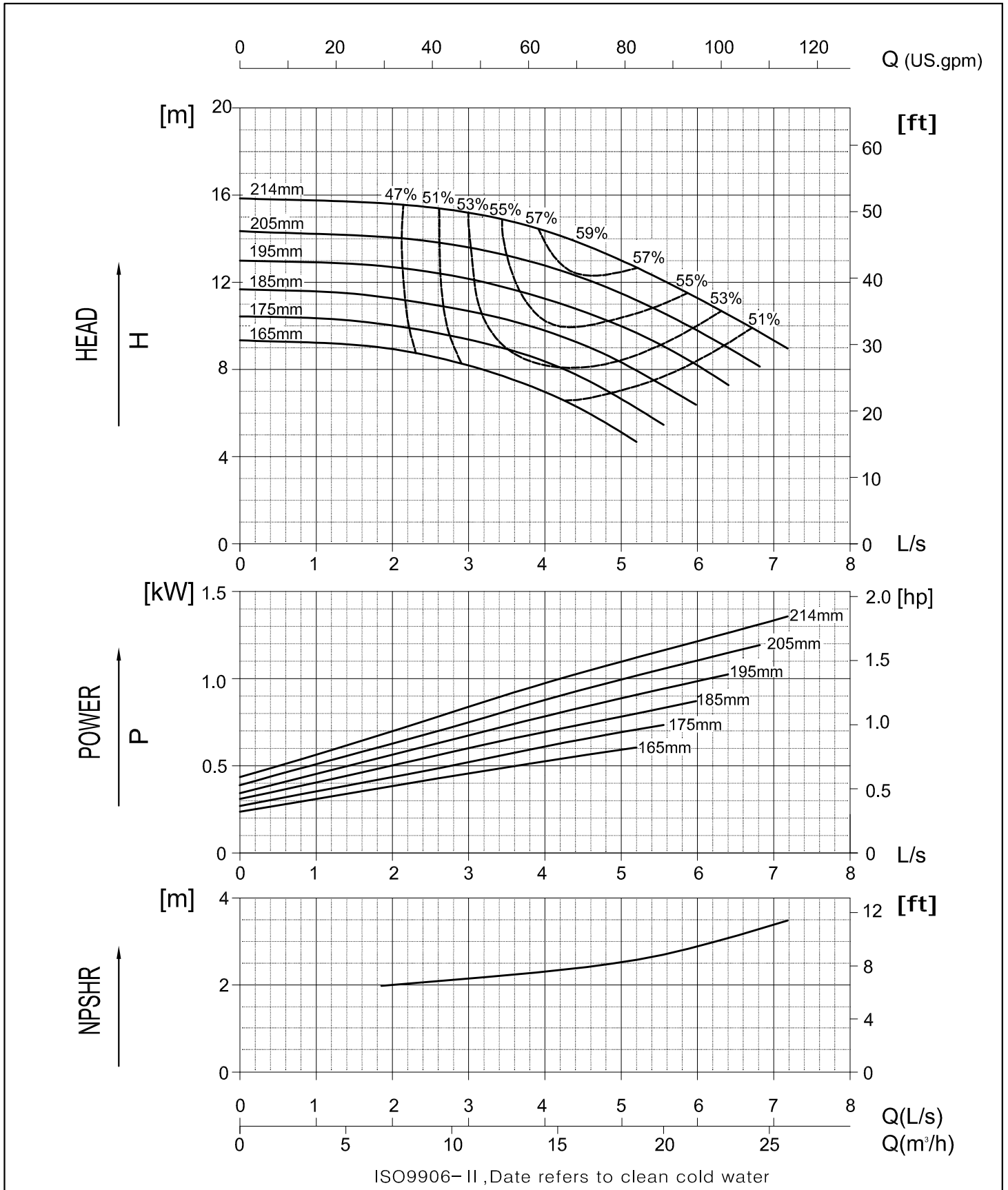

65-40-260

Performance Curve

1450 rpm

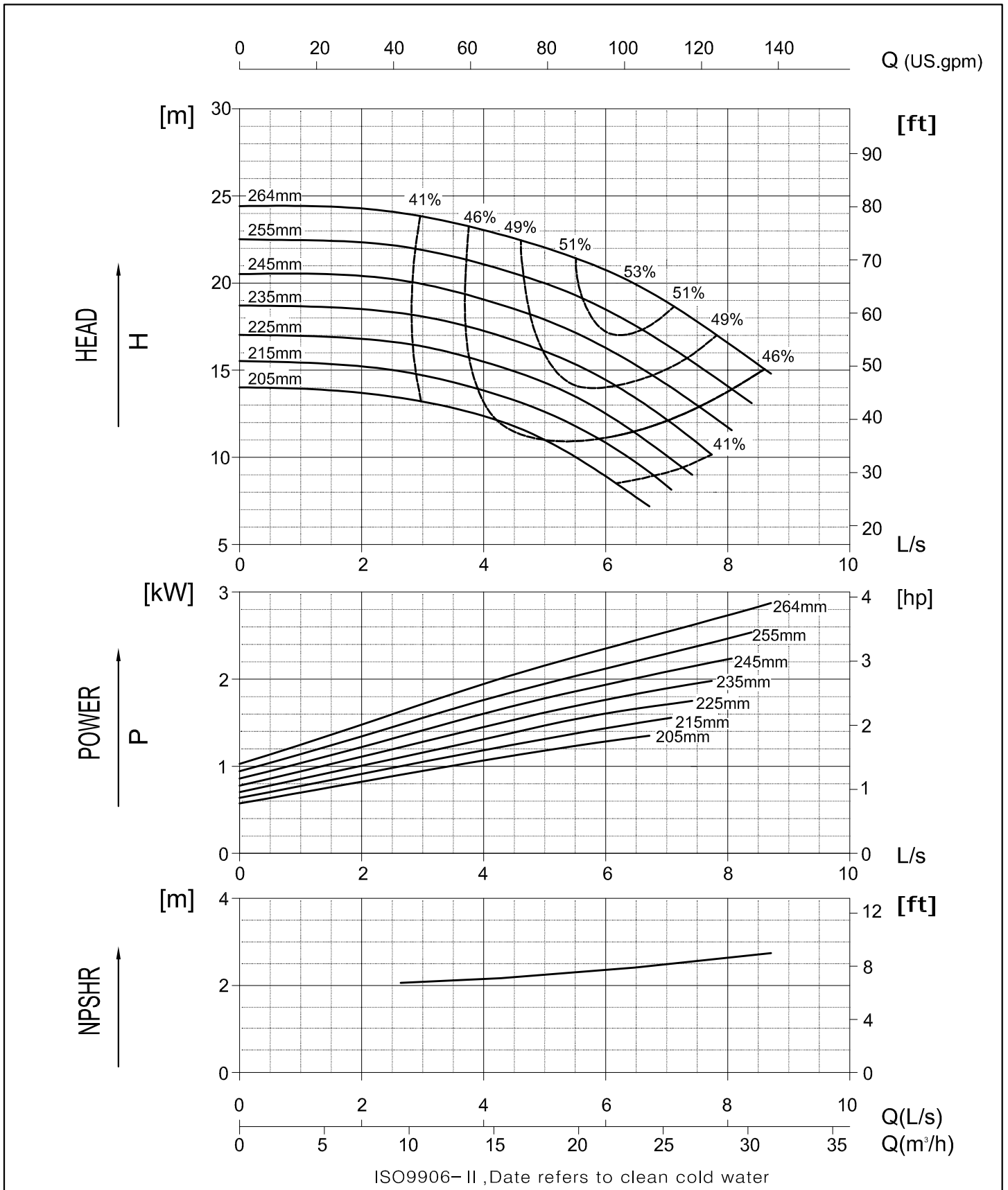

65-40-320

Performance Curve

1450 rpm

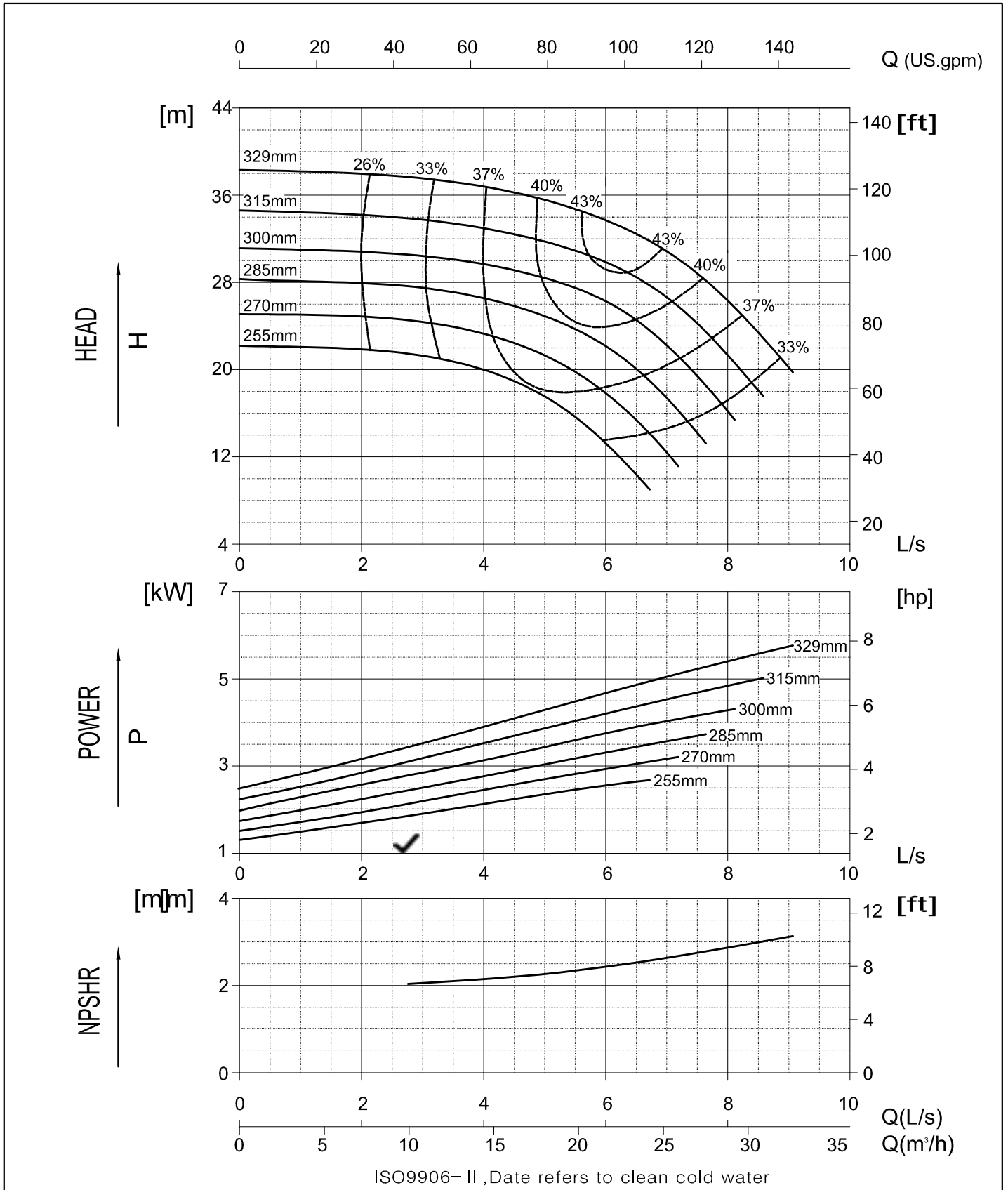

65-50-130

Performance Curve

1450 rpm

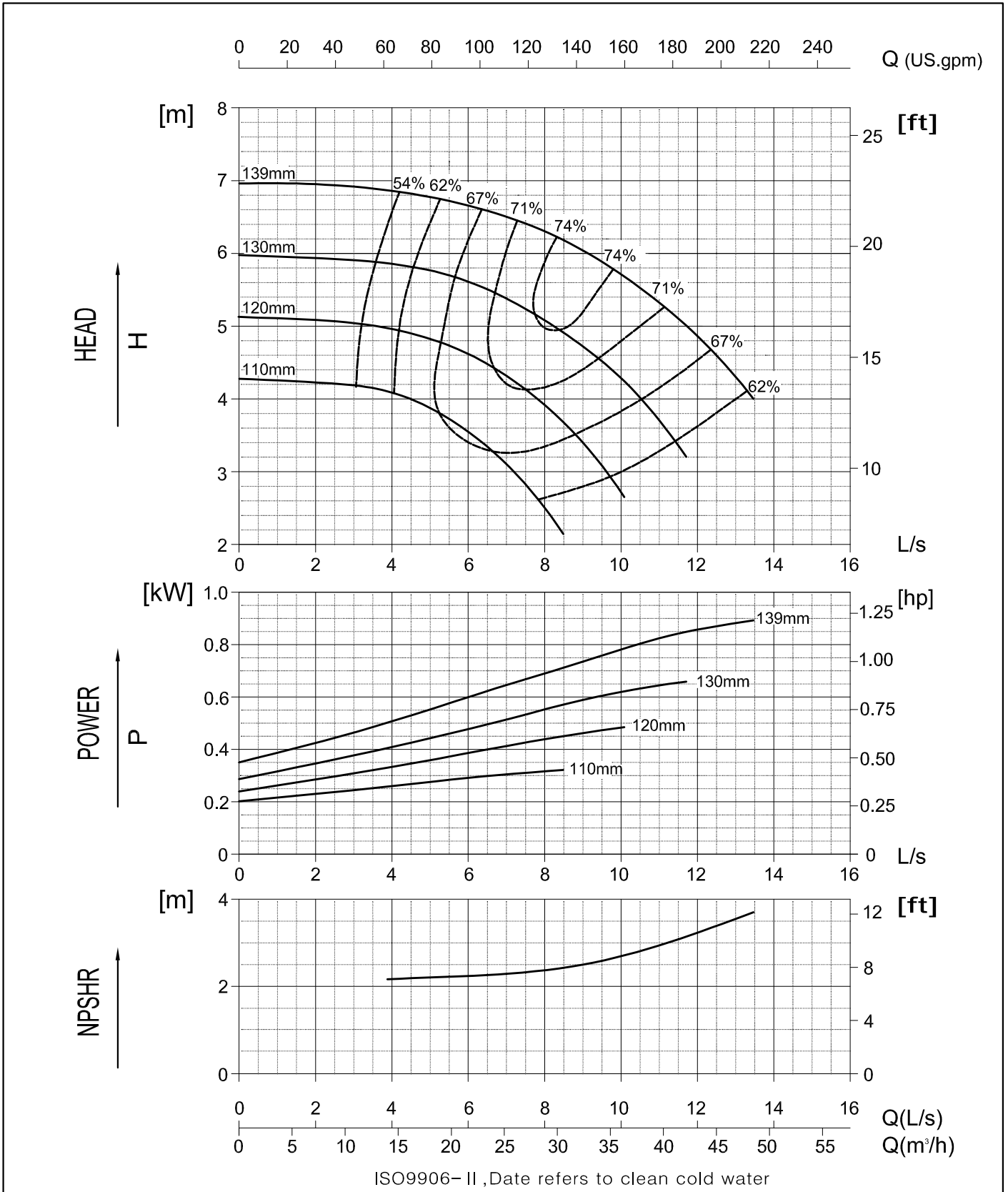

65-50-160

Performance Curve

1450 rpm

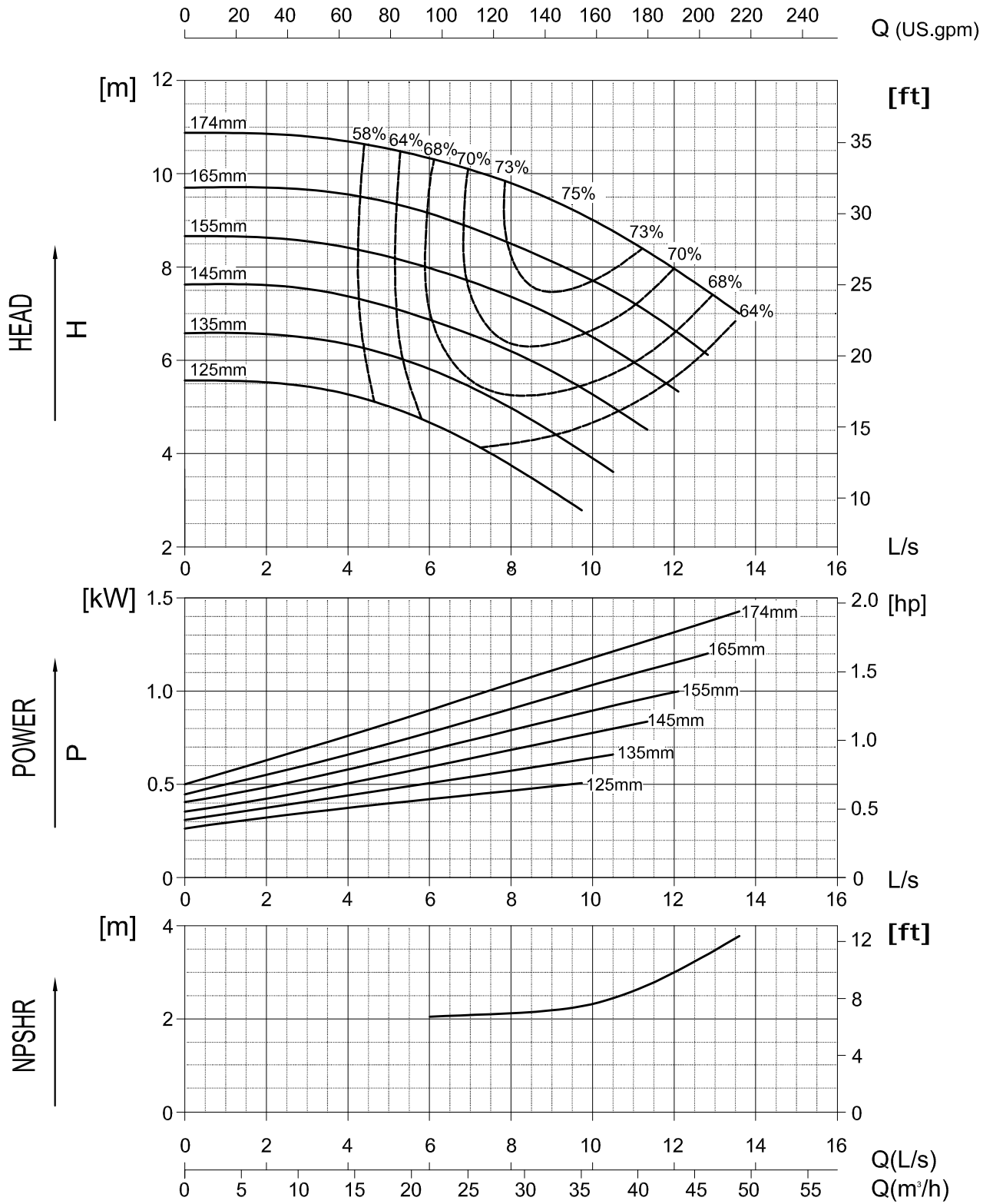

ISO9906-II, Date refers to clean cold water

65-50-200

Performance Curve

1450 rpm

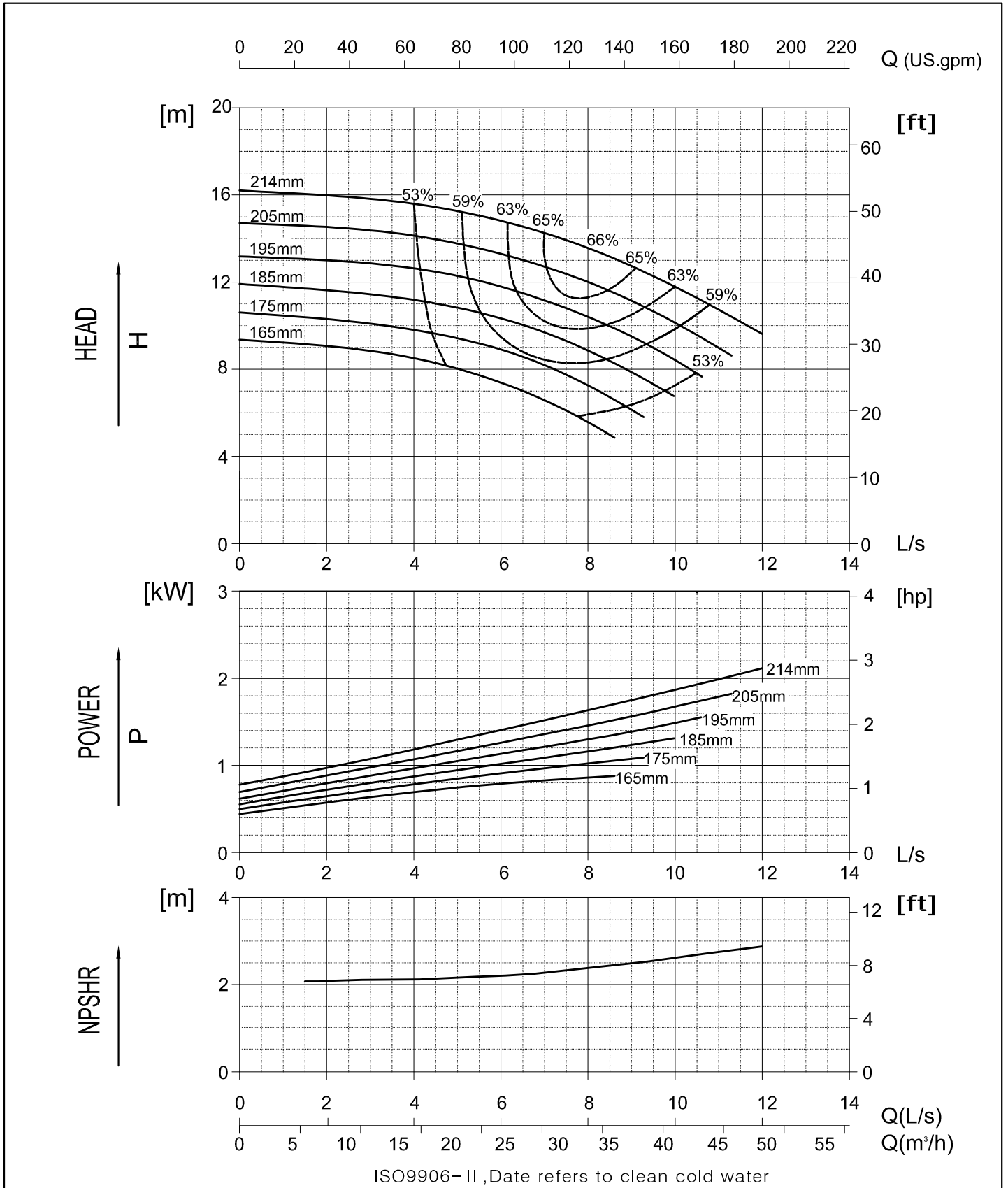

65-50-260

Performance Curve

1450 rpm

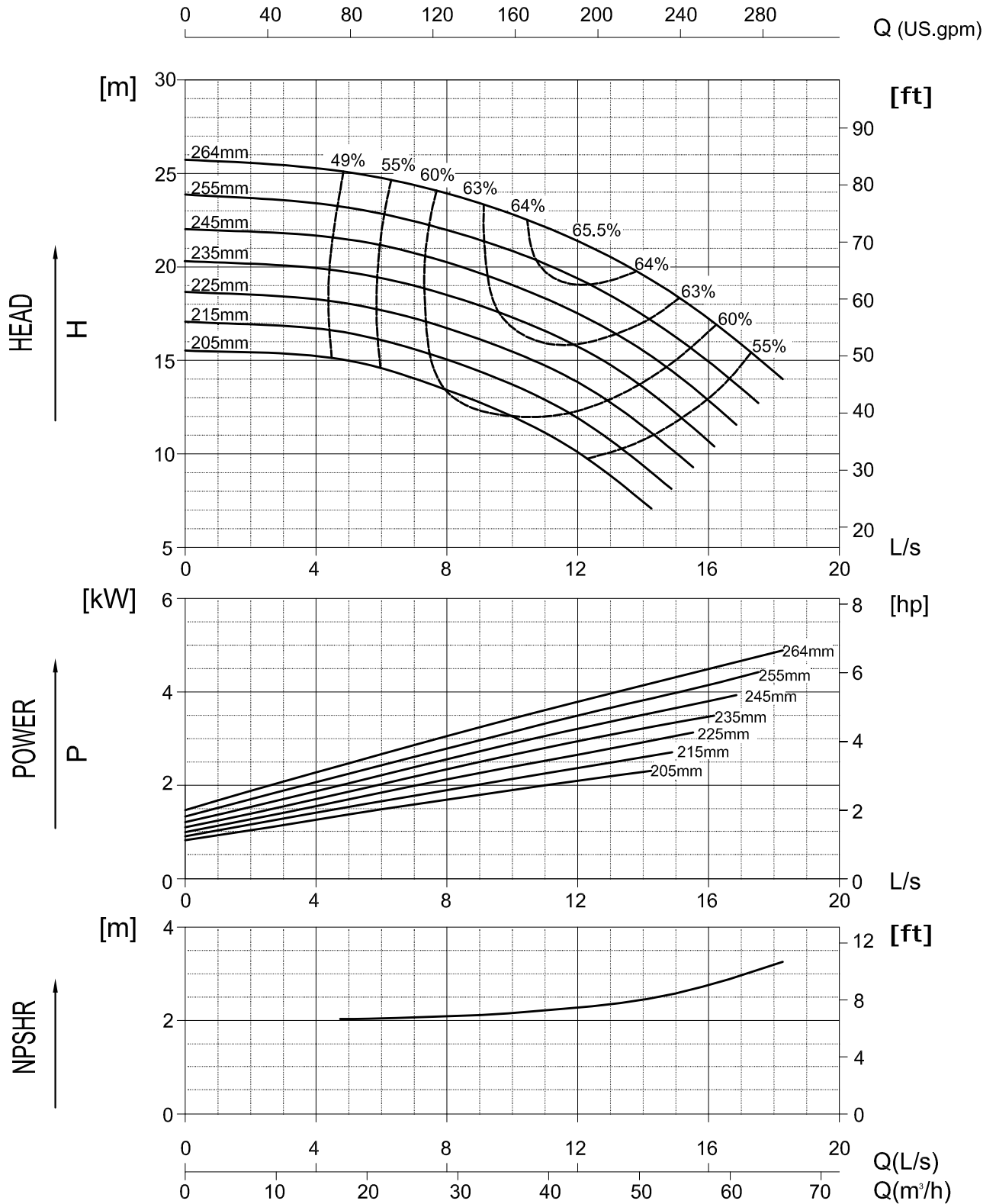

ISO9906-II, Date refers to clean cold water

65-50-320

Performance Curve

1450 rpm

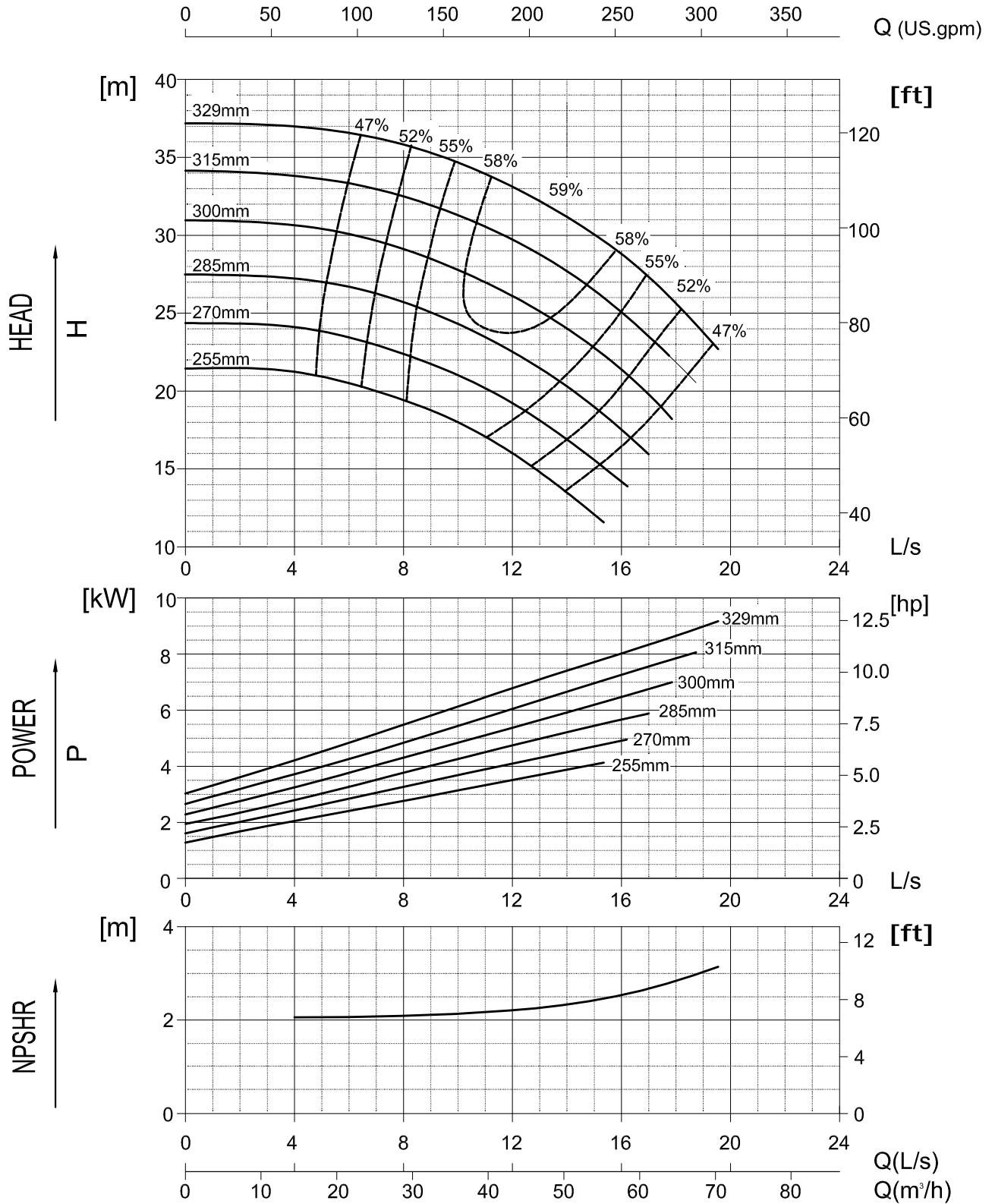

ISO9906- II , Date refers to clean cold water

80-65-130

Performance Curve

1450 rpm

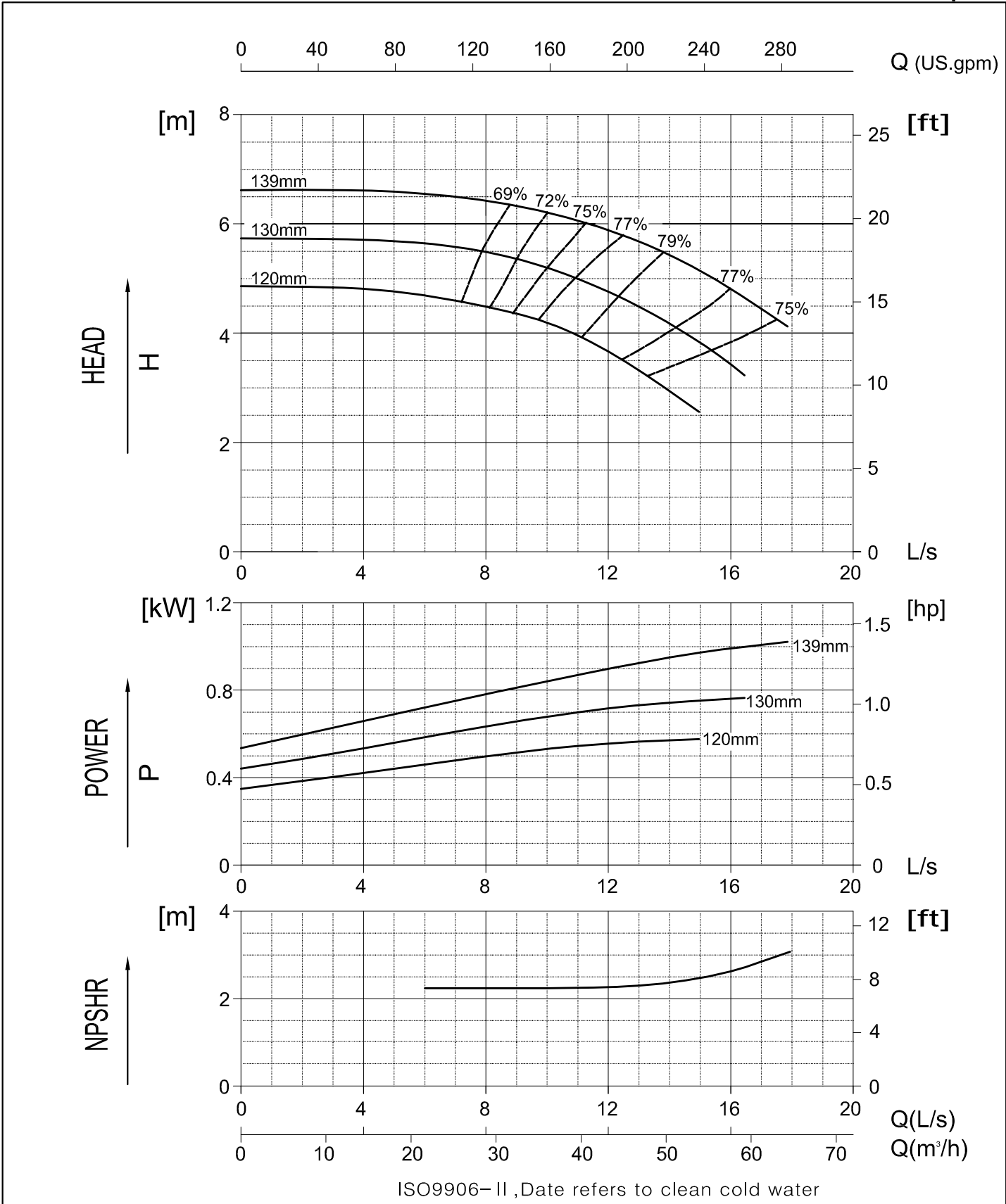

ISO9906-II, Date refers to clean cold water

80-65-160

Performance Curve

1450 rpm

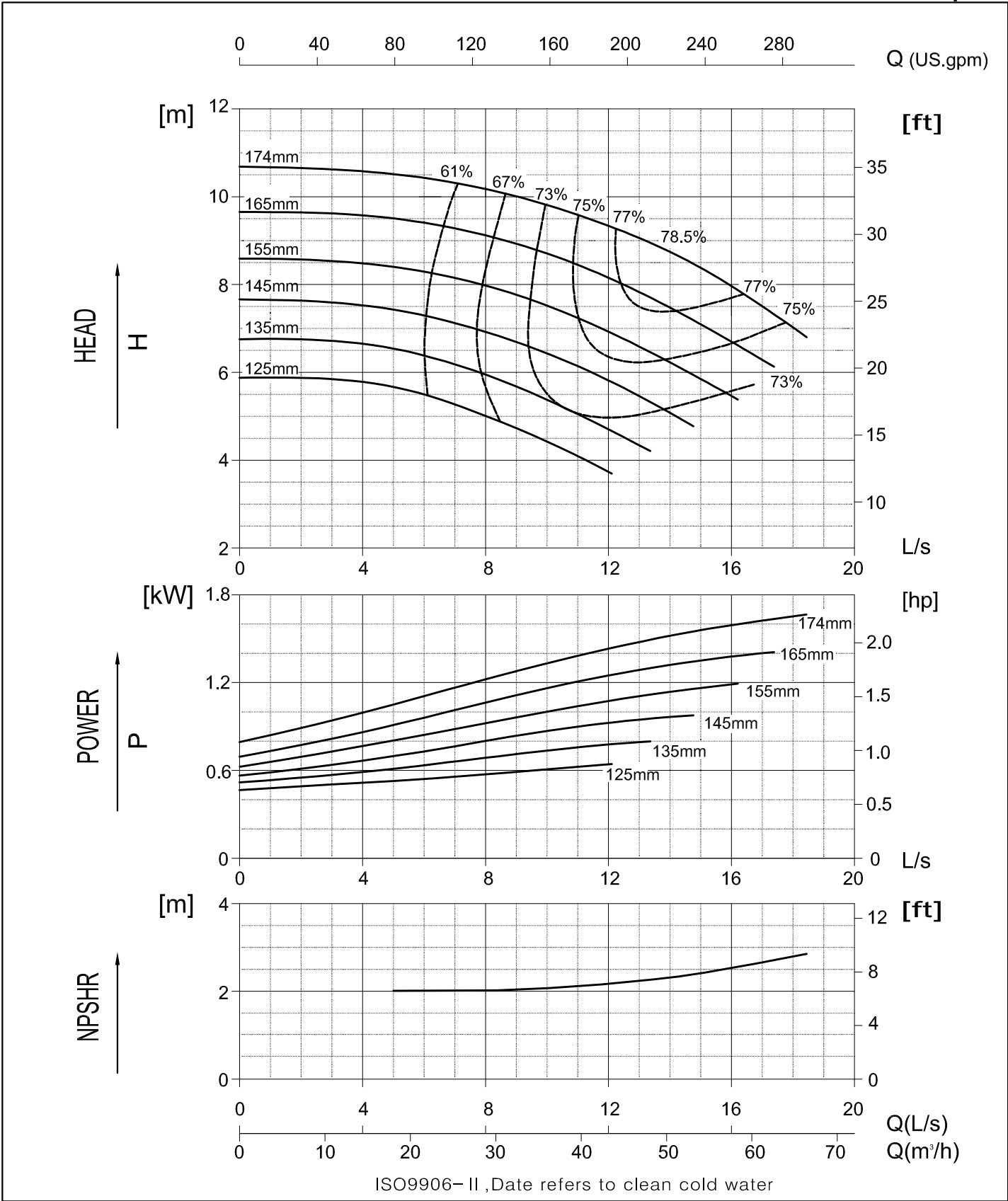

80-65-200

Performance Curve

1450 rpm

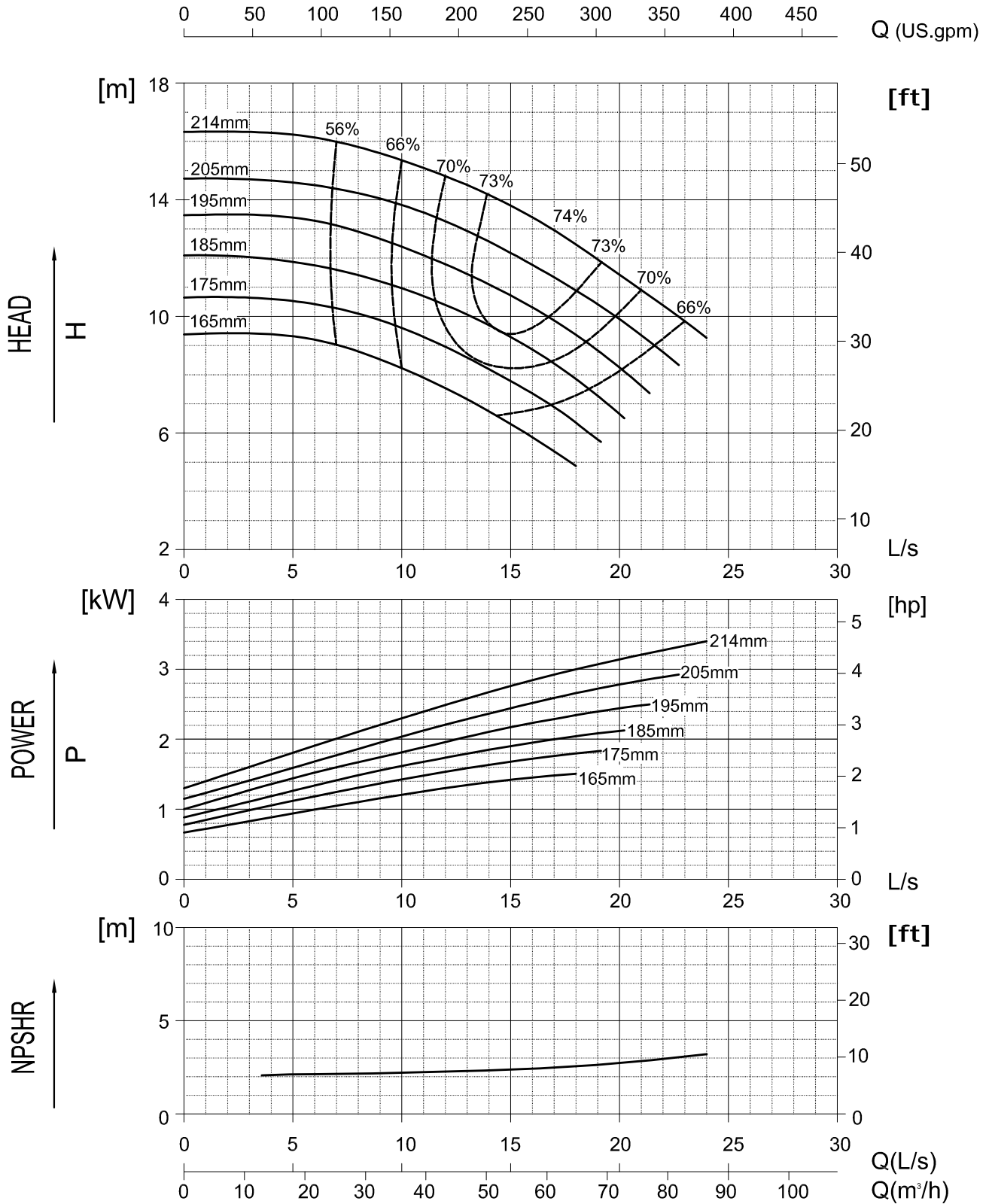

ISO9906-II, Date refers to clean cold water

80-65-260

Performance Curve

1450 rpm

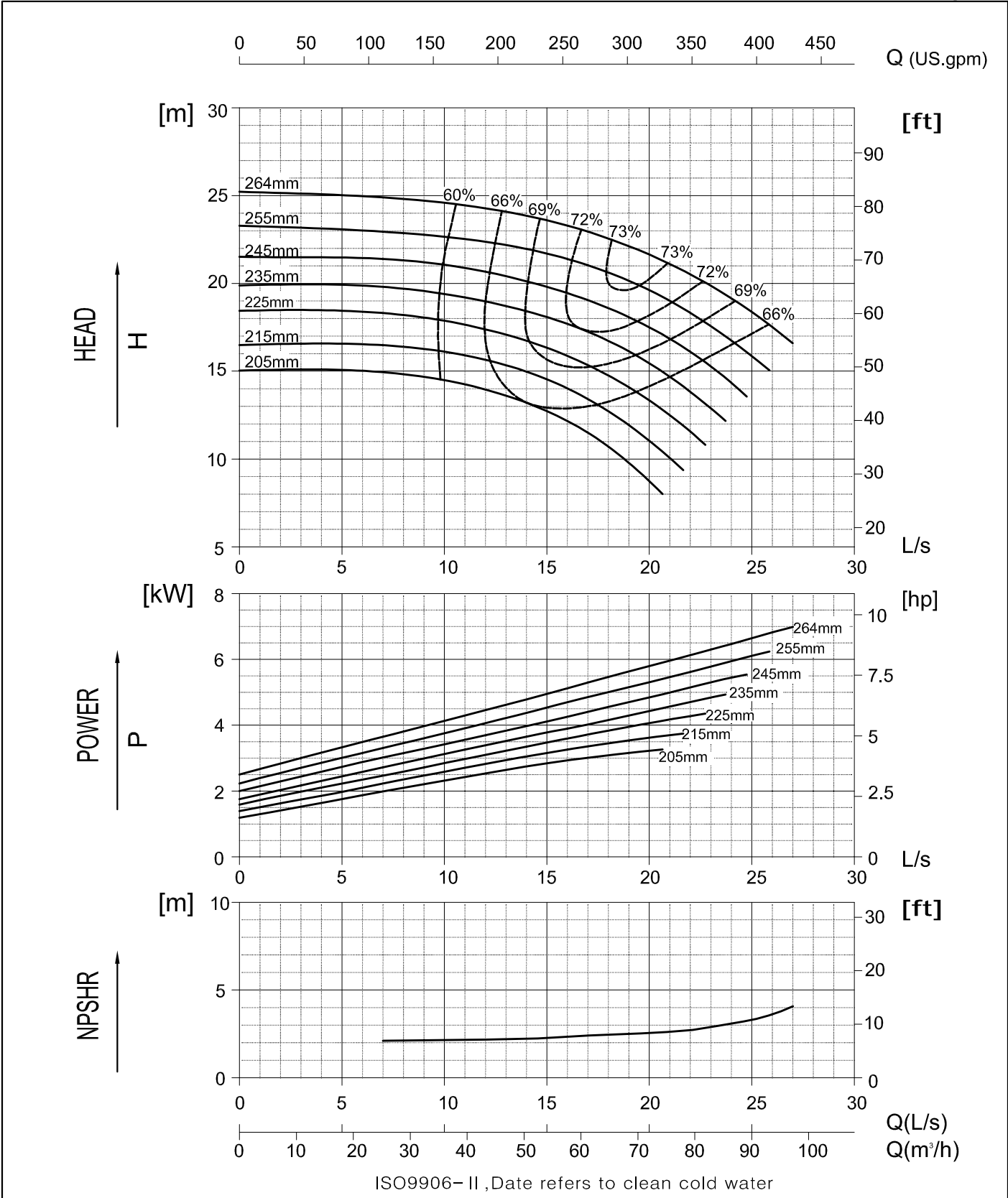

80-65-320

Performance Curve

1450 rpm

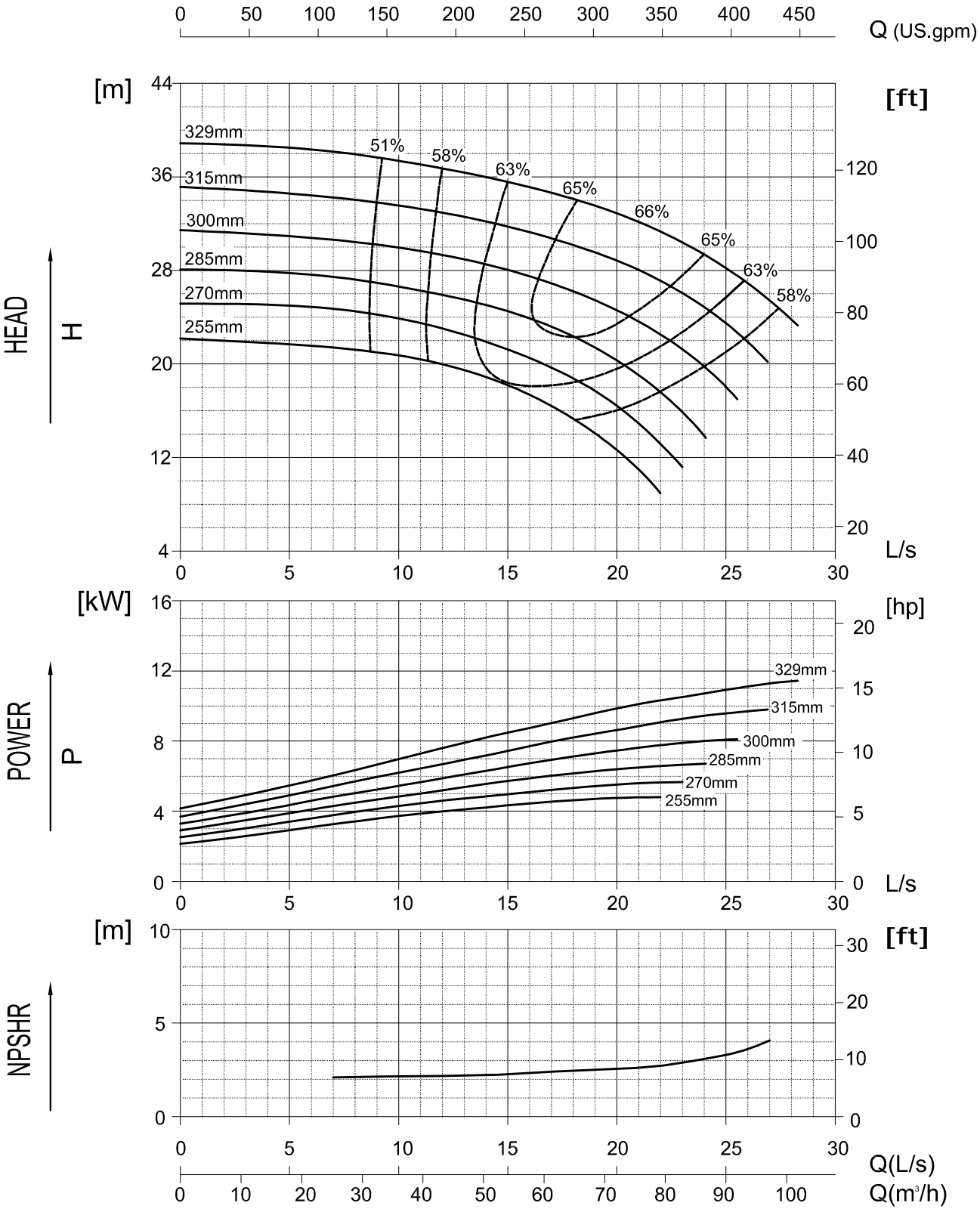

ISO9906-II, Date refers to clean cold water

100-80-160

Performance Curve

1450 rpm

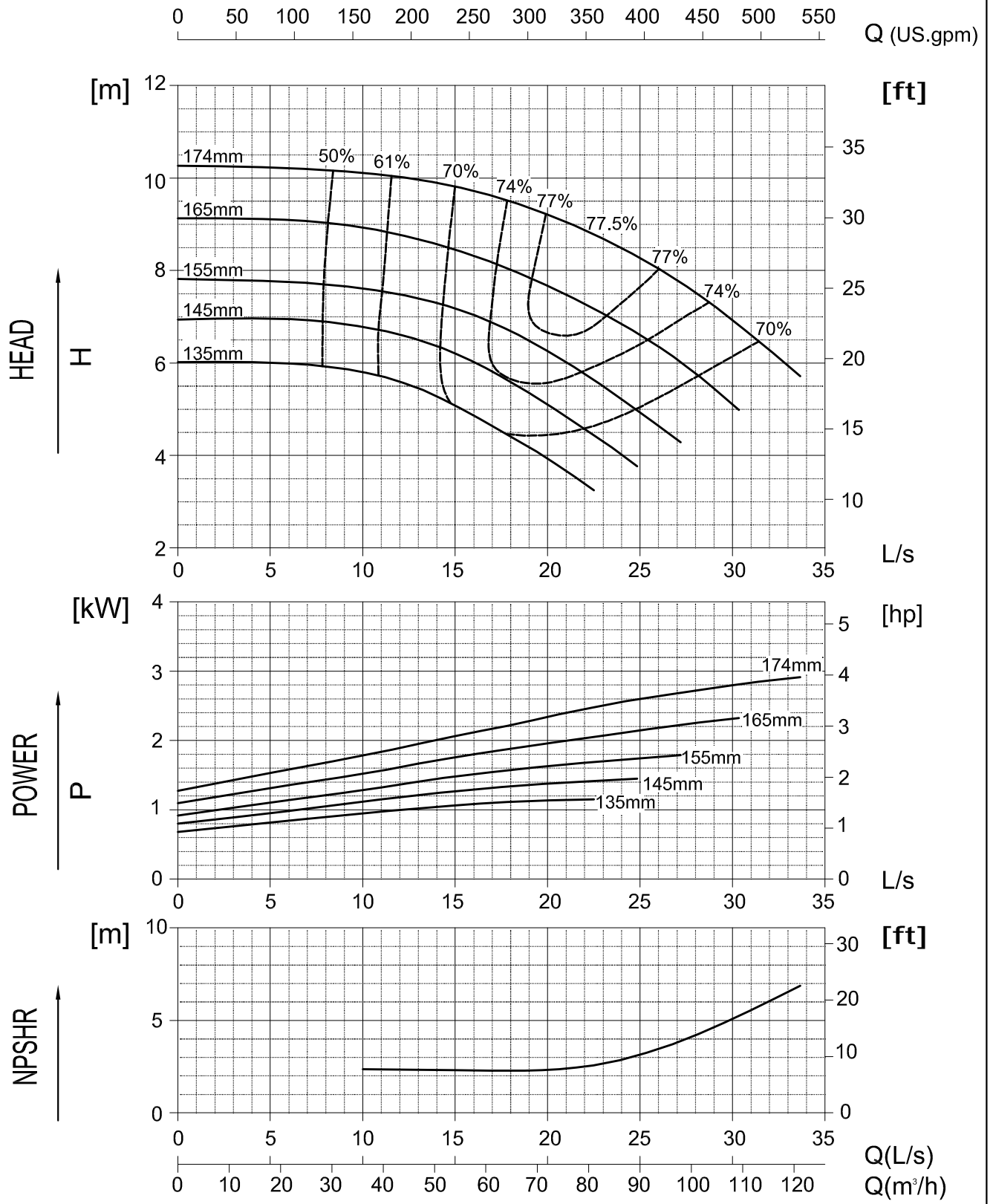

ISO9906-II, Date refers to clean cold water

100-80-200

Performance Curve

1450 rpm

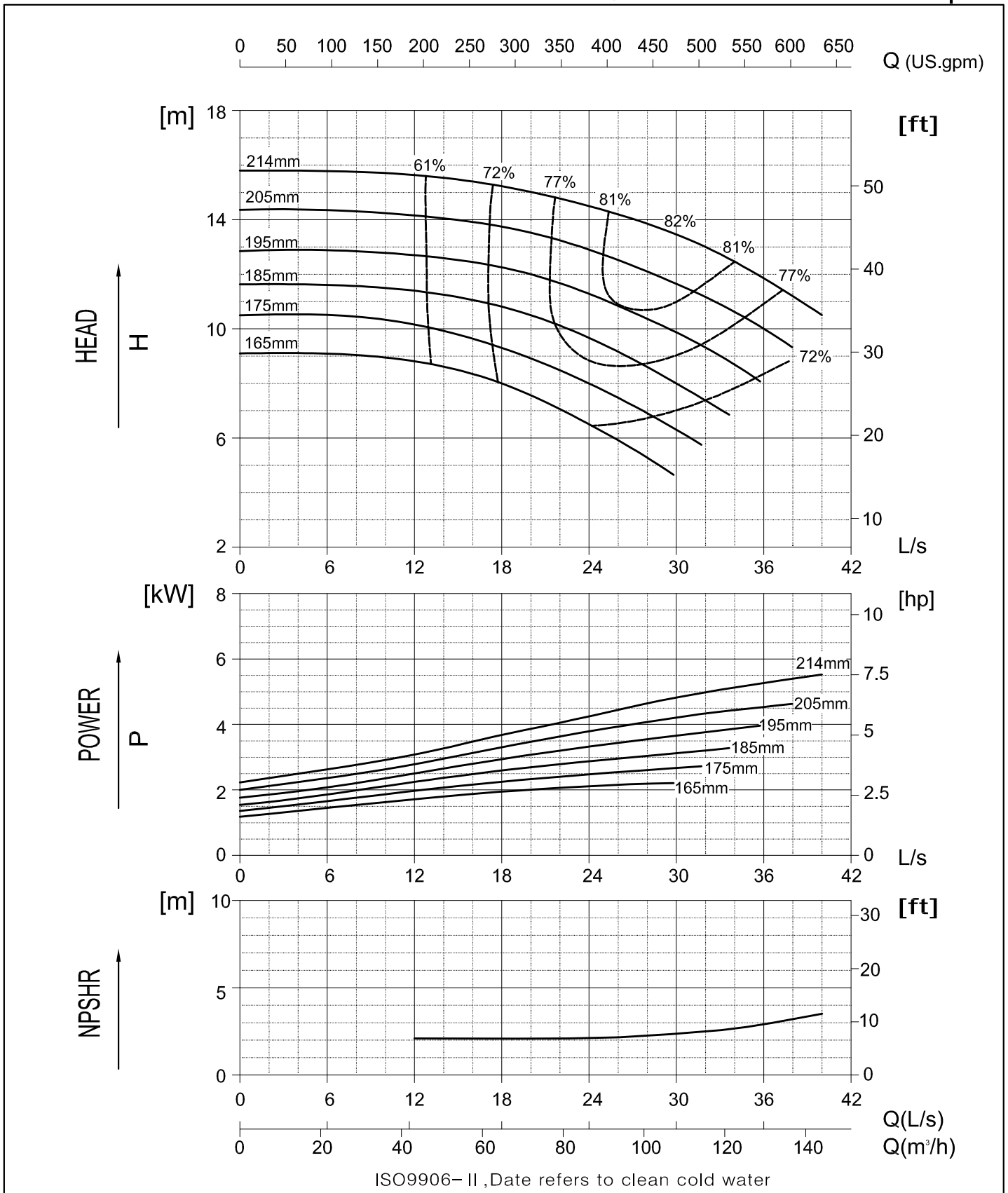

100-80-260

Performance Curve

1450 rpm

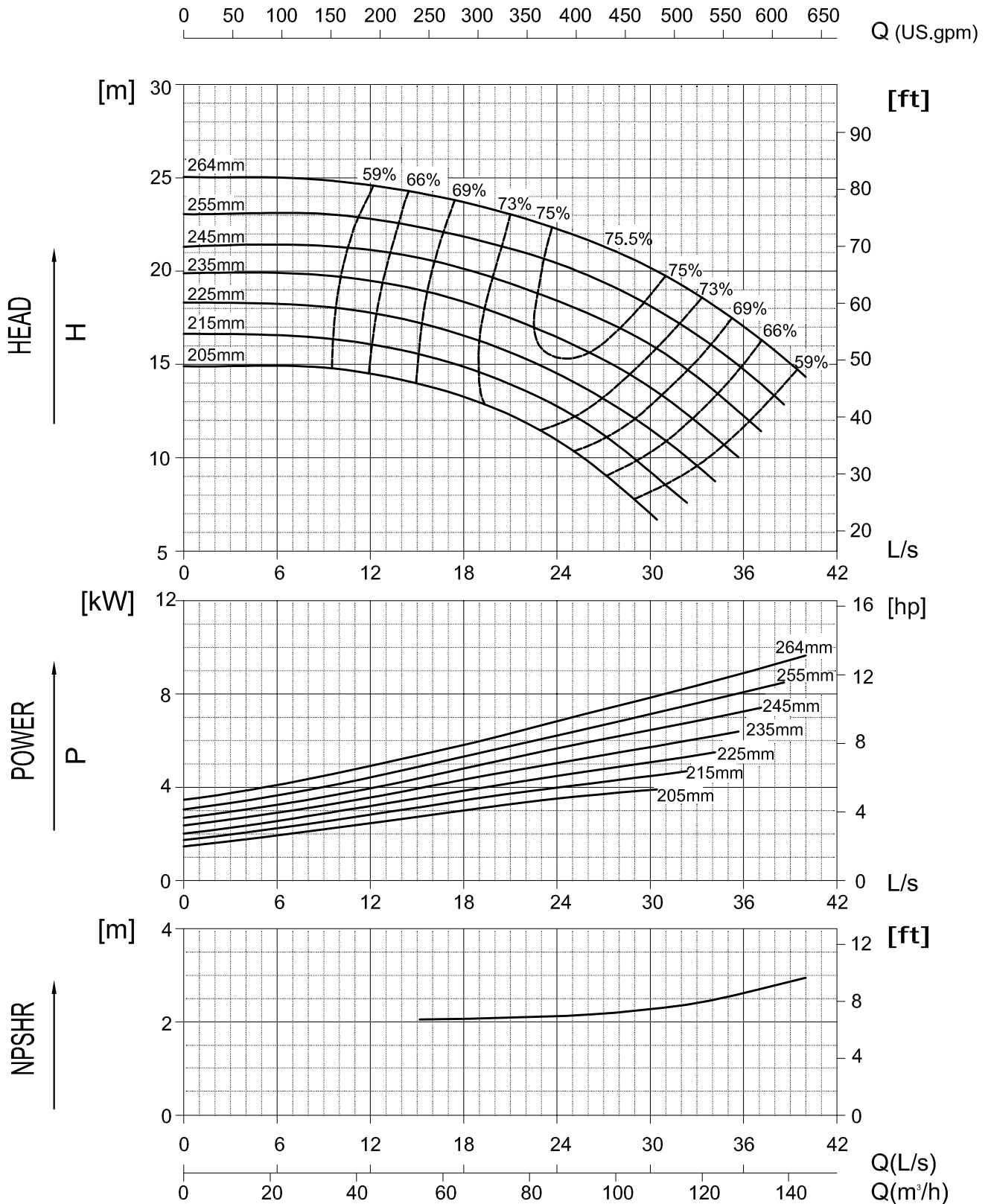

ISO9906-II, Date refers to clean cold water

100-80-320

Performance Curve

1450 rpm

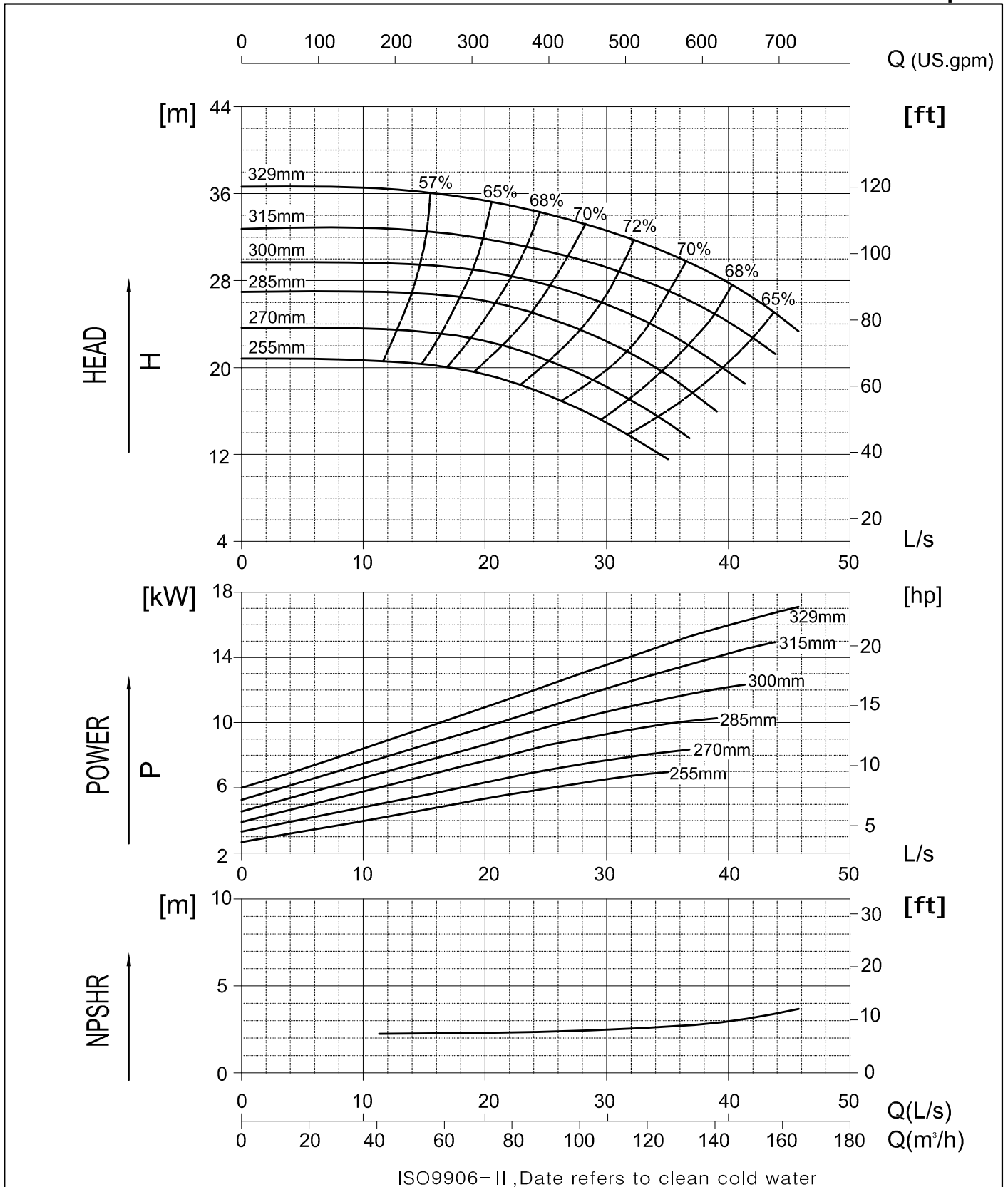

100-80-400

Performance Curve

1450 rpm

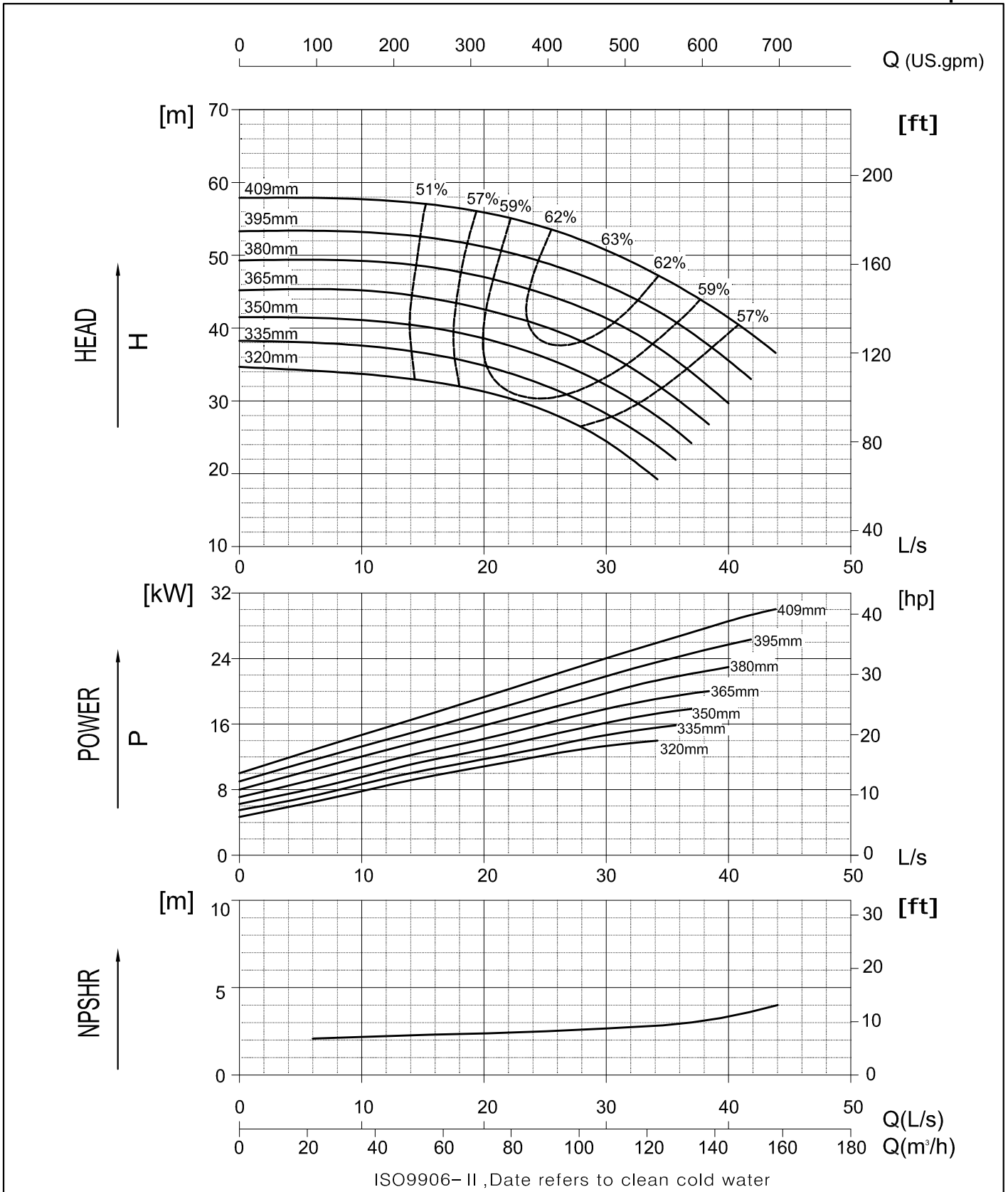

125-100-160

Performance Curve

1450 rpm

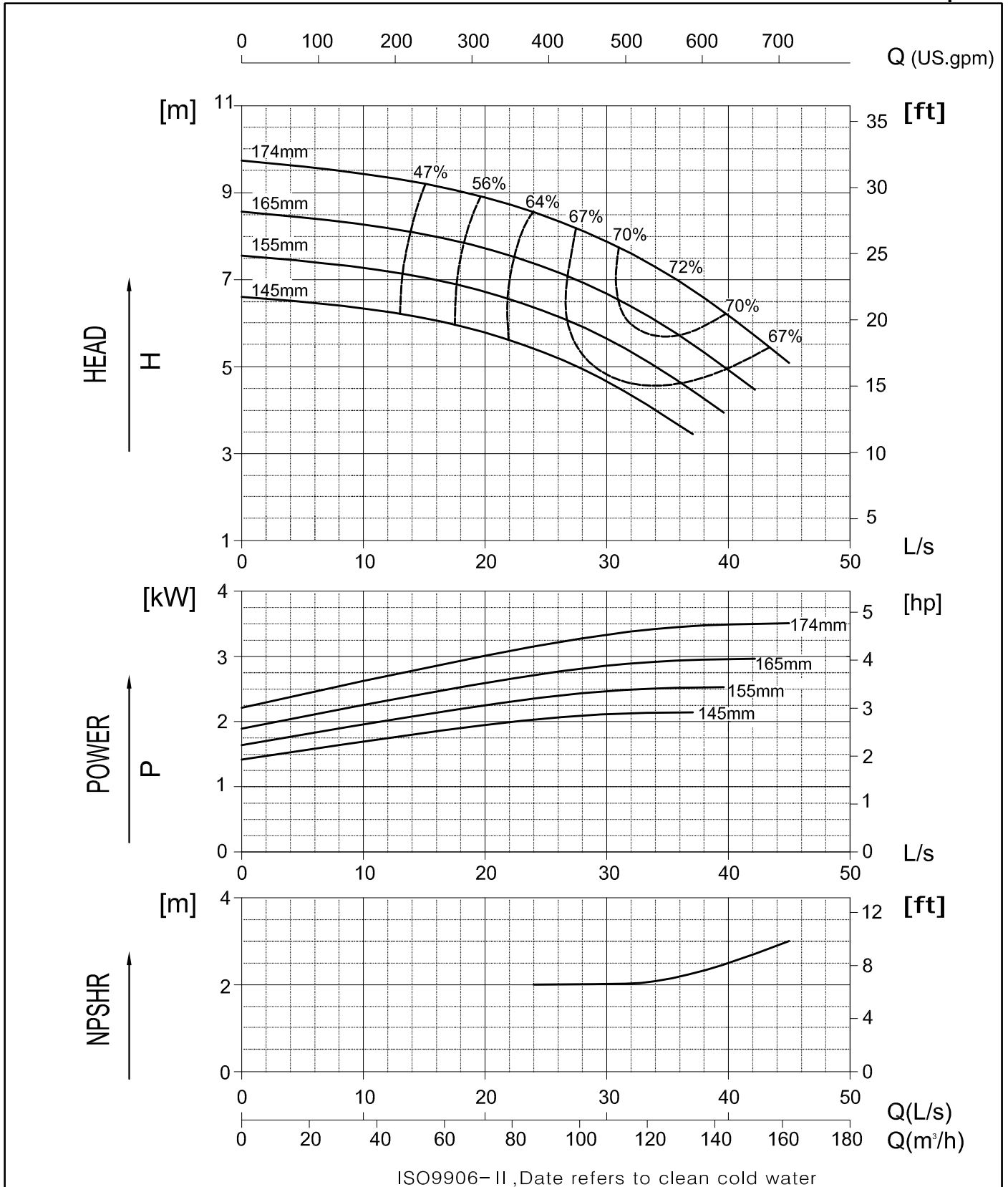

ISO9906-II, Date refers to clean cold water

125-100-200

Performance Curve

1450 rpm

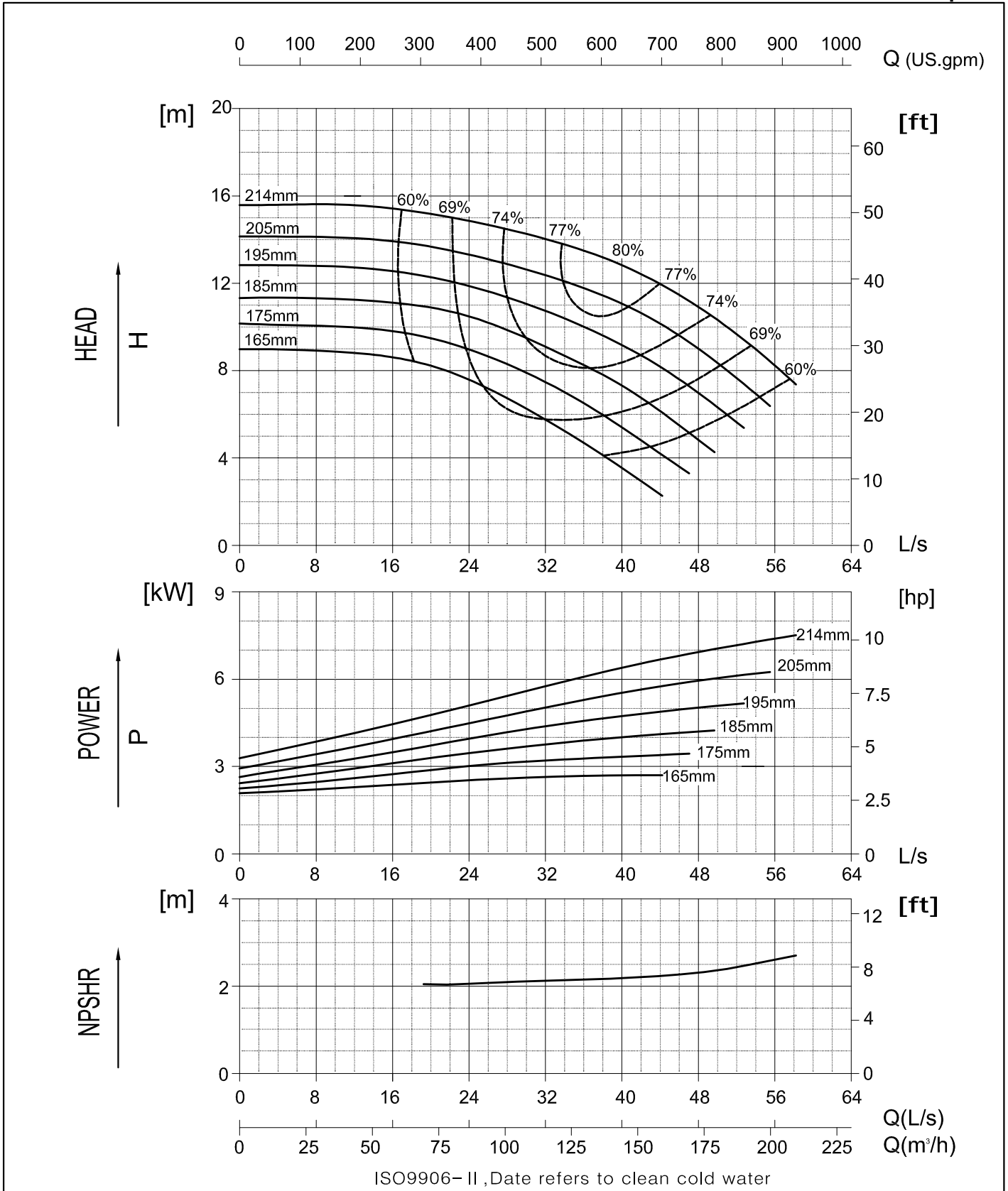

125-100-260

Performance Curve

1450 rpm

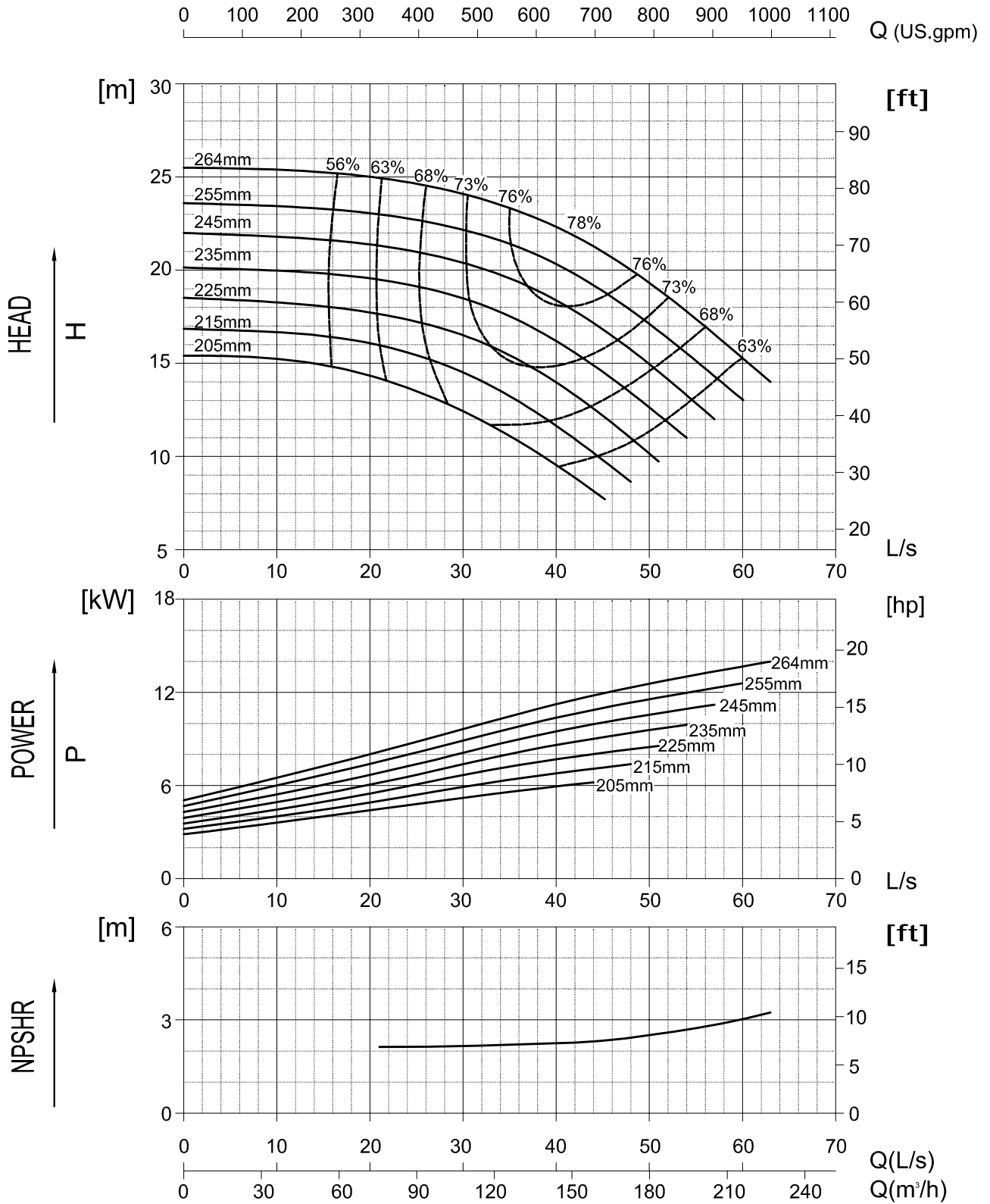

ISO9906-II, Date refers to clean cold water

125-100-320

Performance Curve

1450 rpm

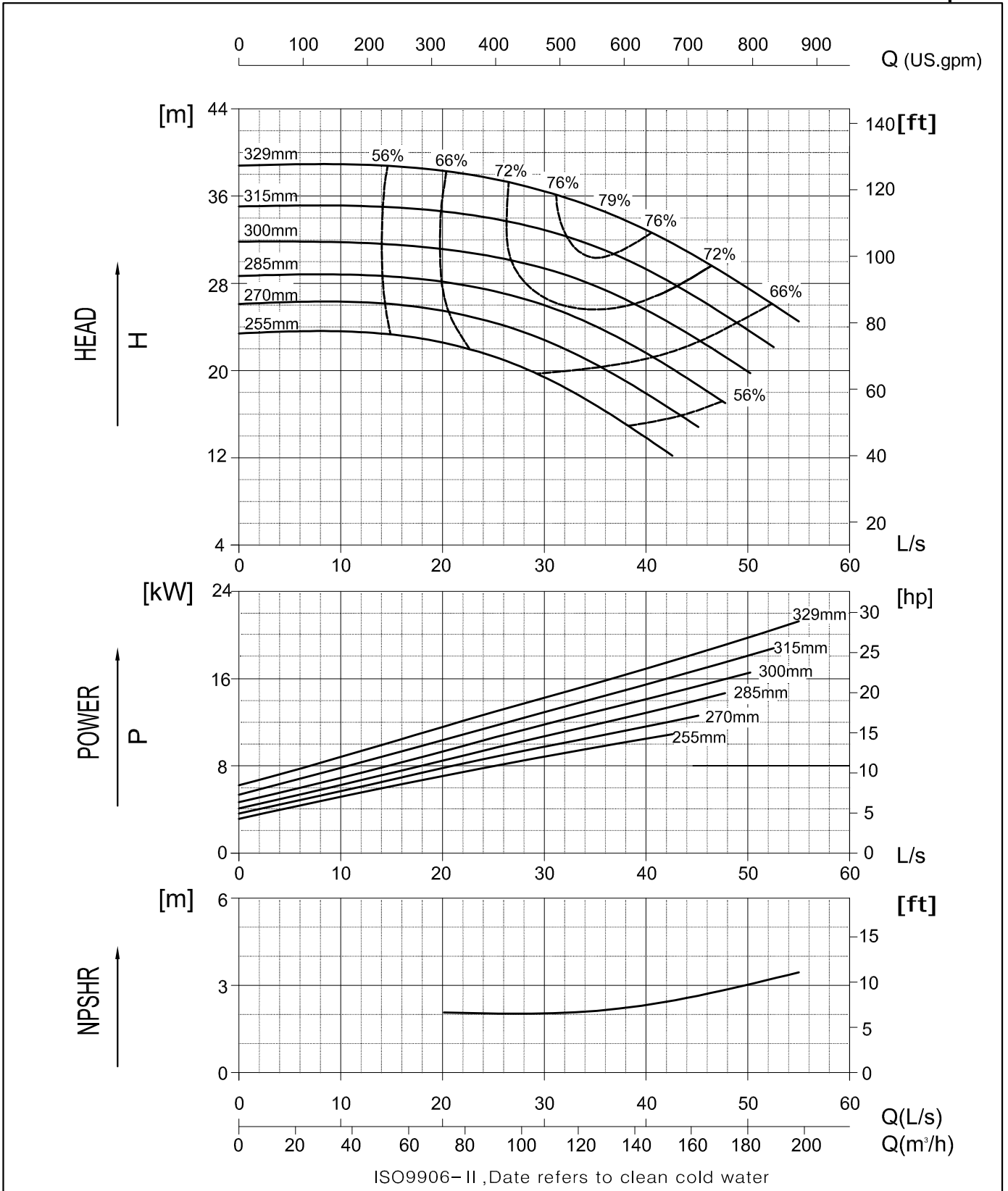

125-100-400

Performance Curve

1450 rpm

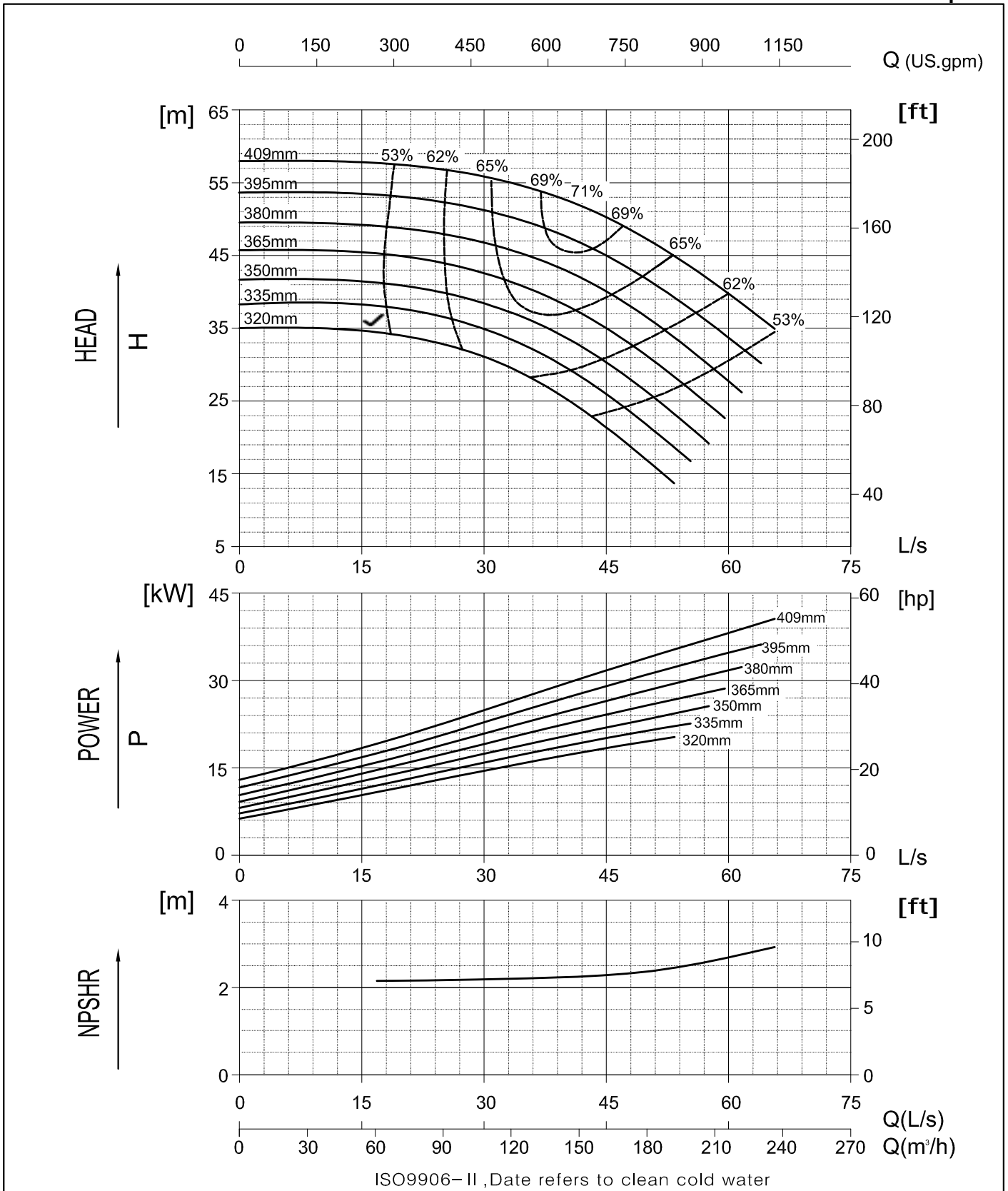

150-125-200

Performance Curve

1450 rpm

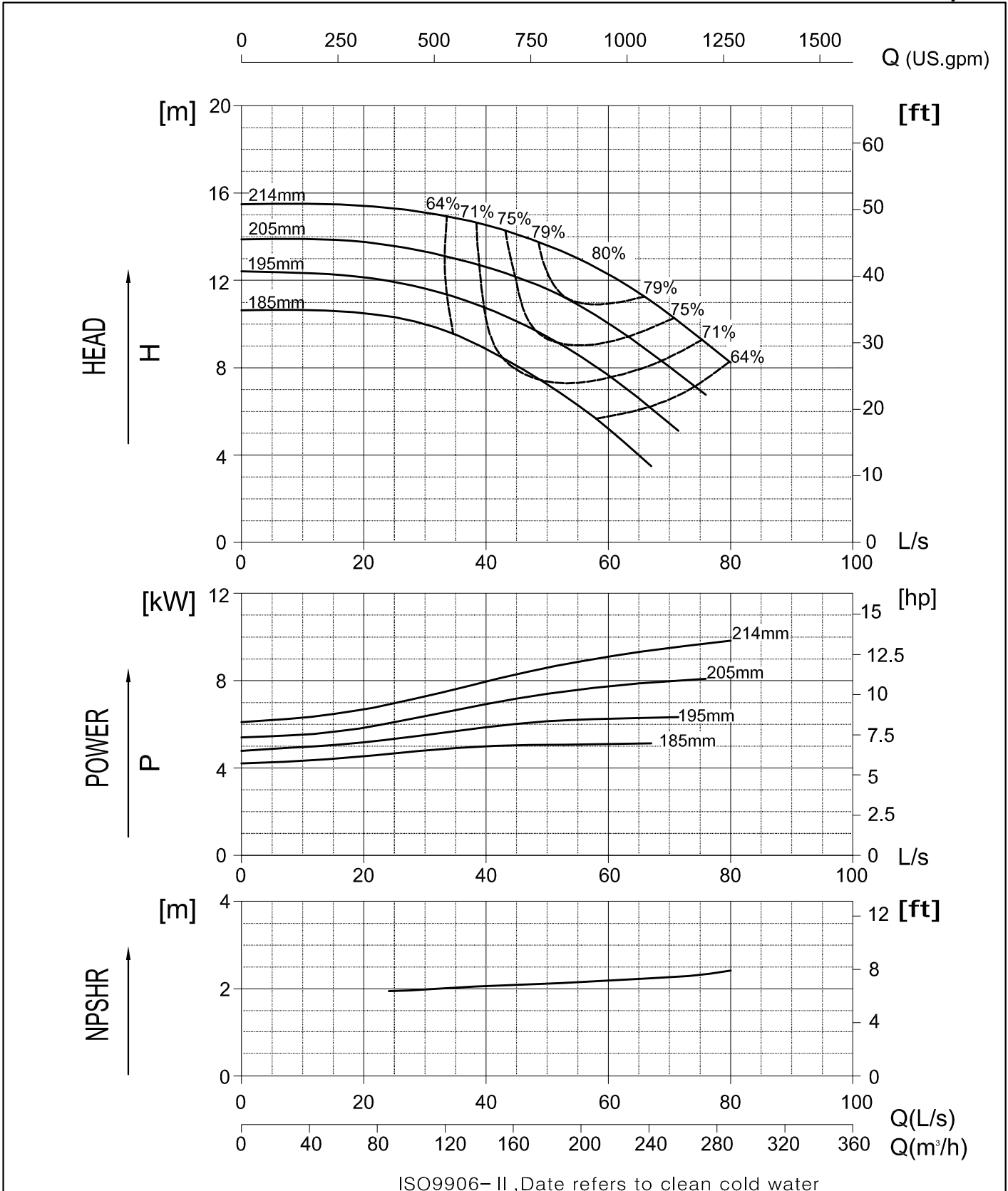

ISO9906-II, Date refers to clean cold water

150-125-260

Performance Curve

1450 rpm

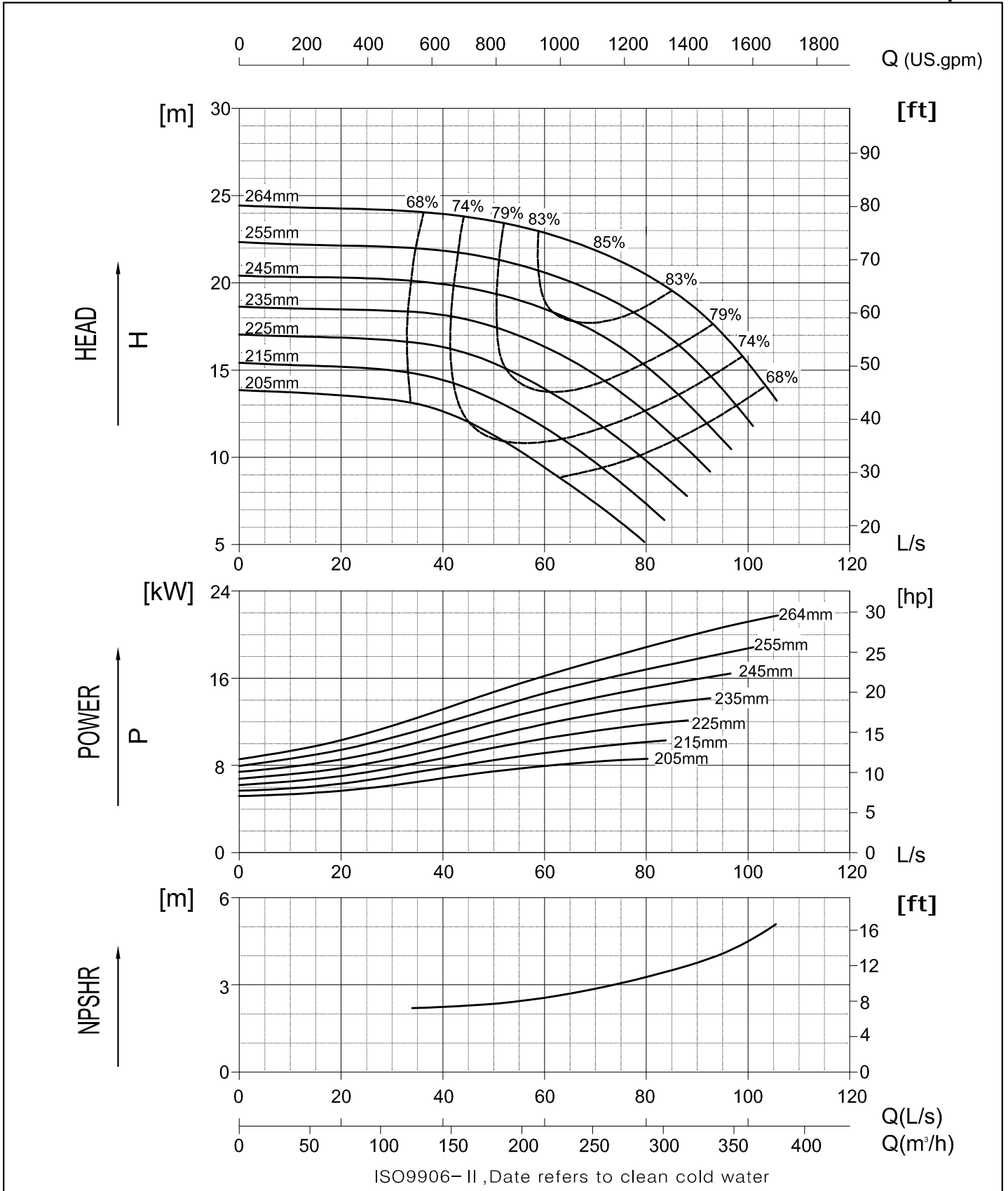

150-125-320

Performance Curve

1450 rpm

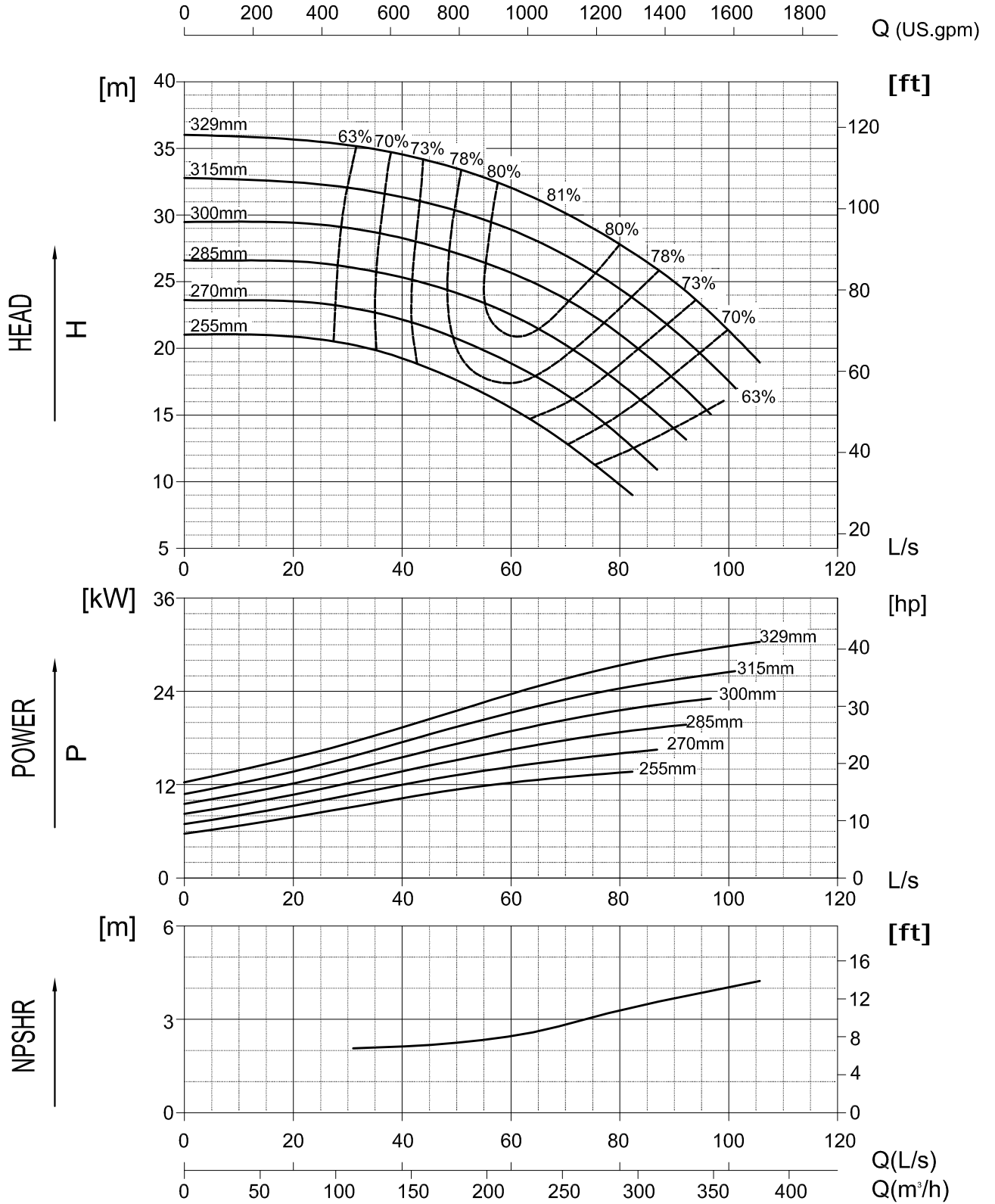

ISO9906- II , Date refers to clean cold water

150-125-400

Performance Curve

1450 rpm

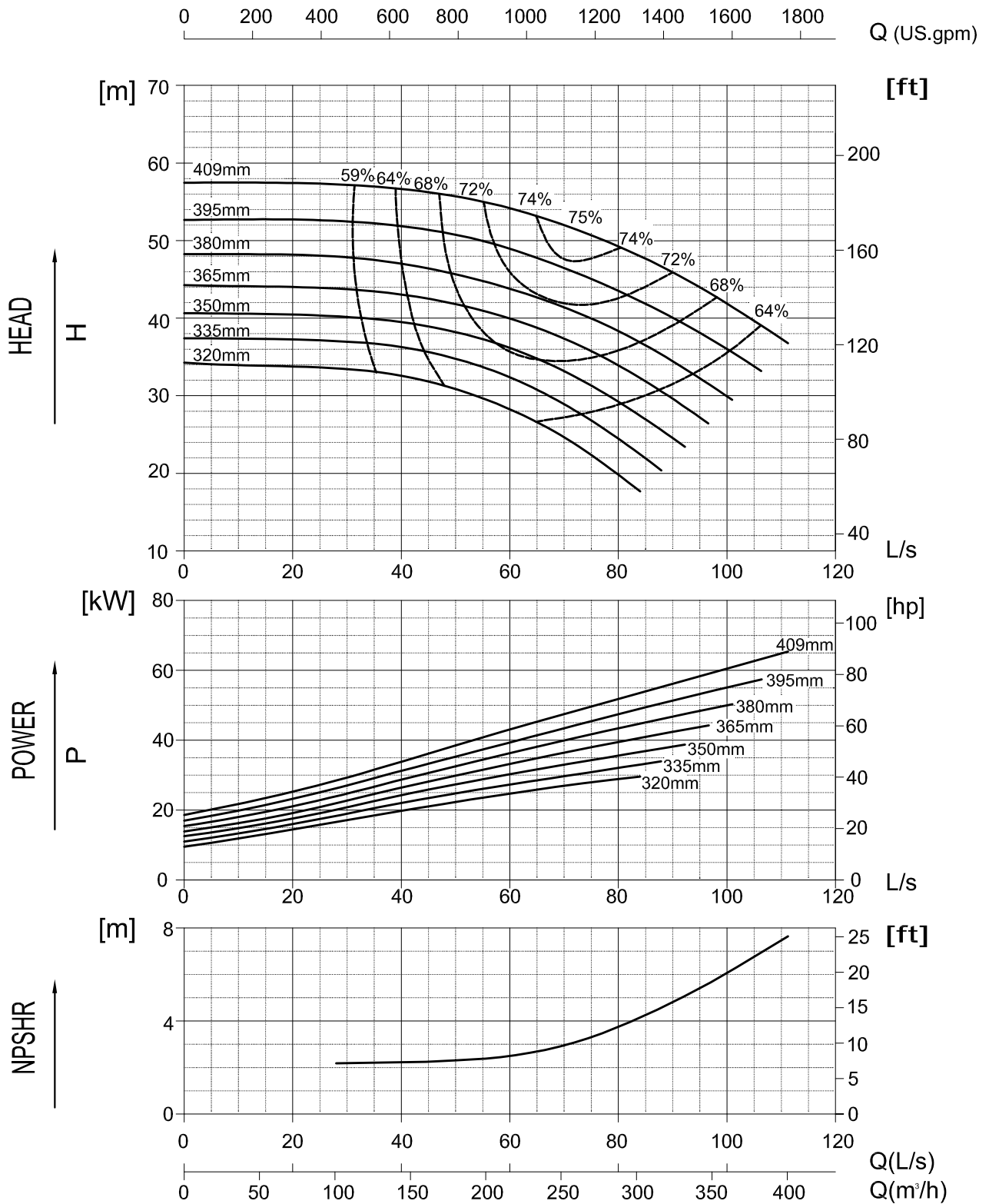

ISO9906-II, Date refers to clean cold water

200-150-200

Performance Curve

1450 rpm

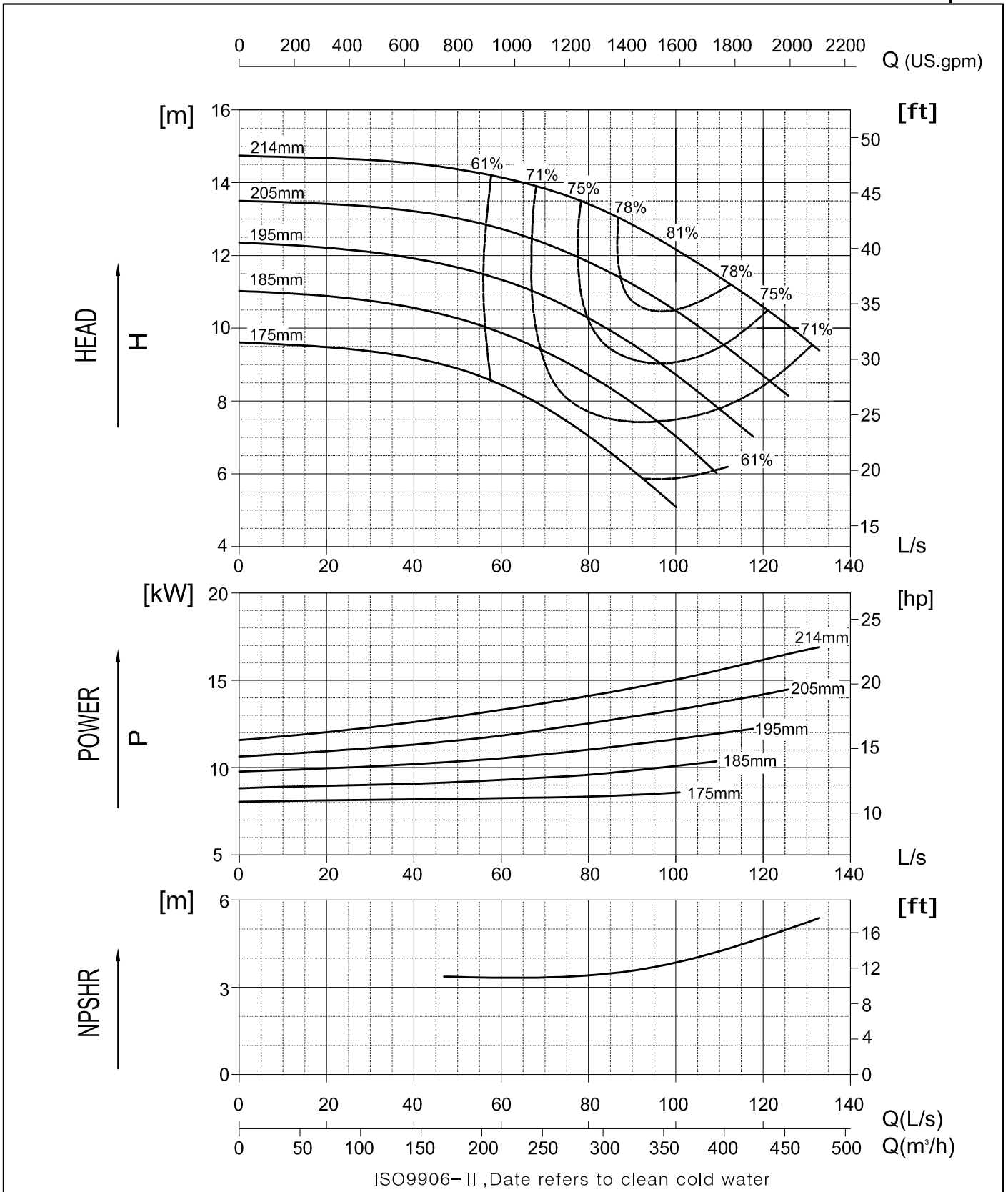

200-150-260

Performance Curve

1450 rpm

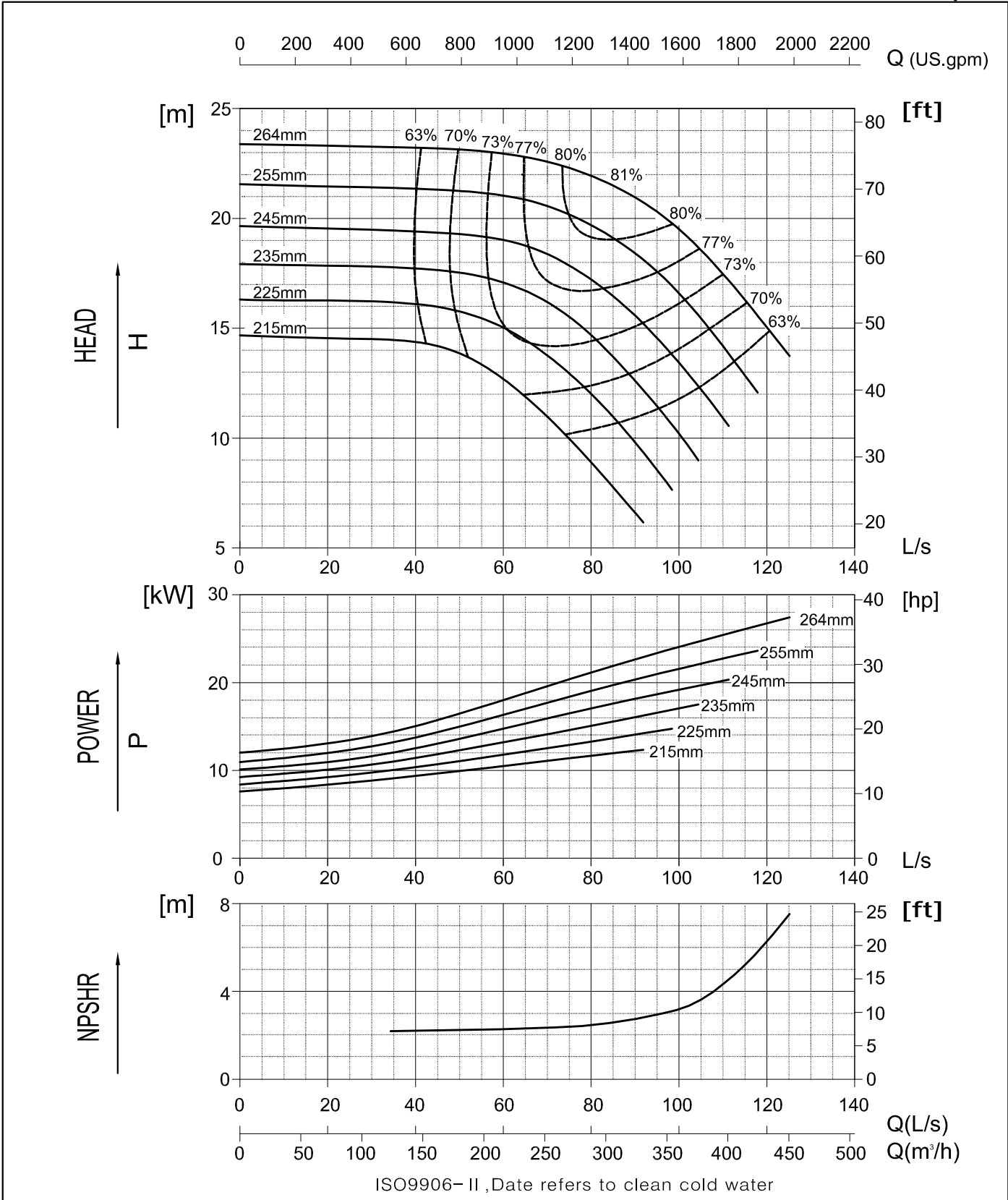

ISO9906-II, Date refers to clean cold water

200-150-320

Performance Curve

1450 rpm

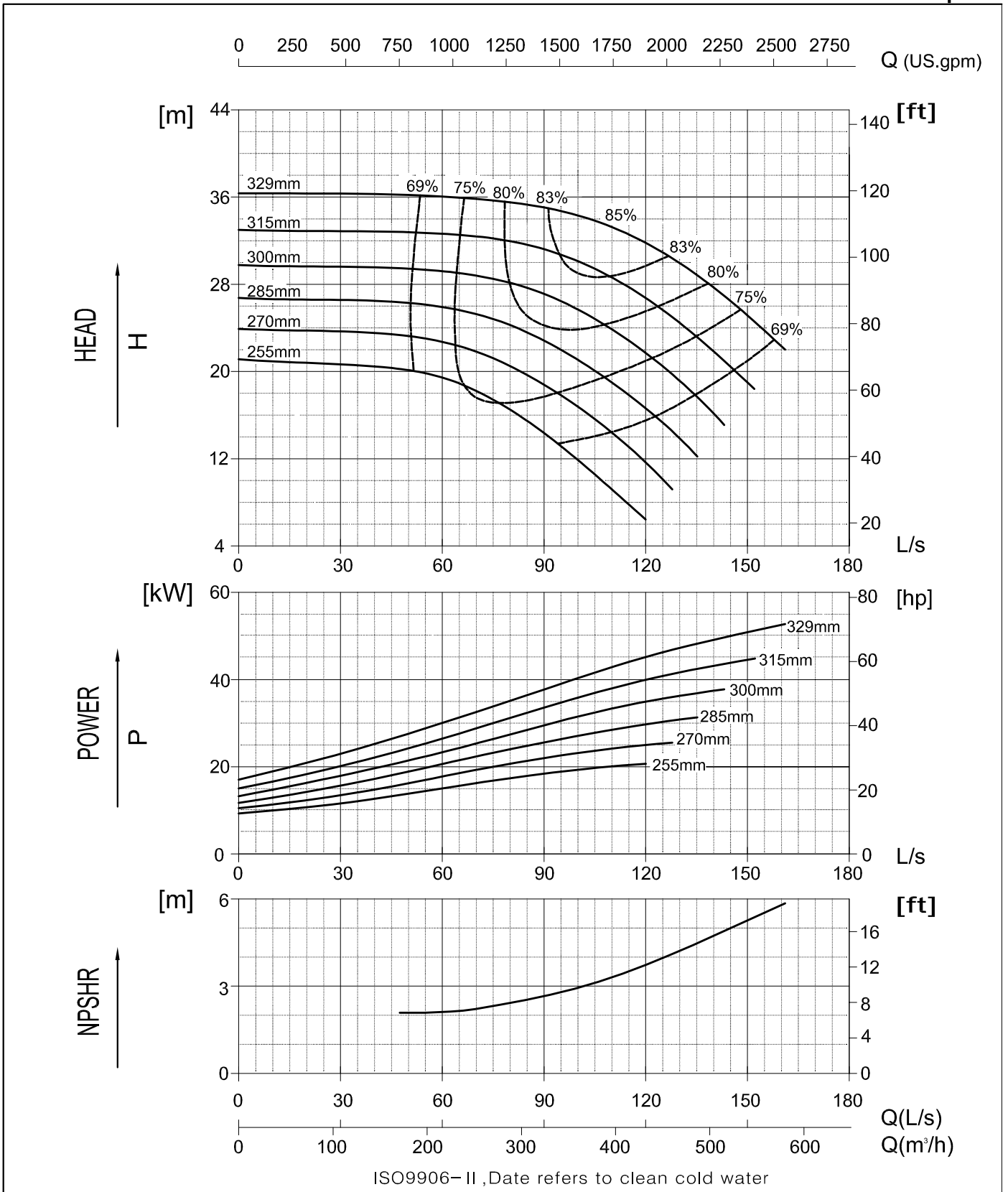

200-150-400

Performance Curve

1450 rpm

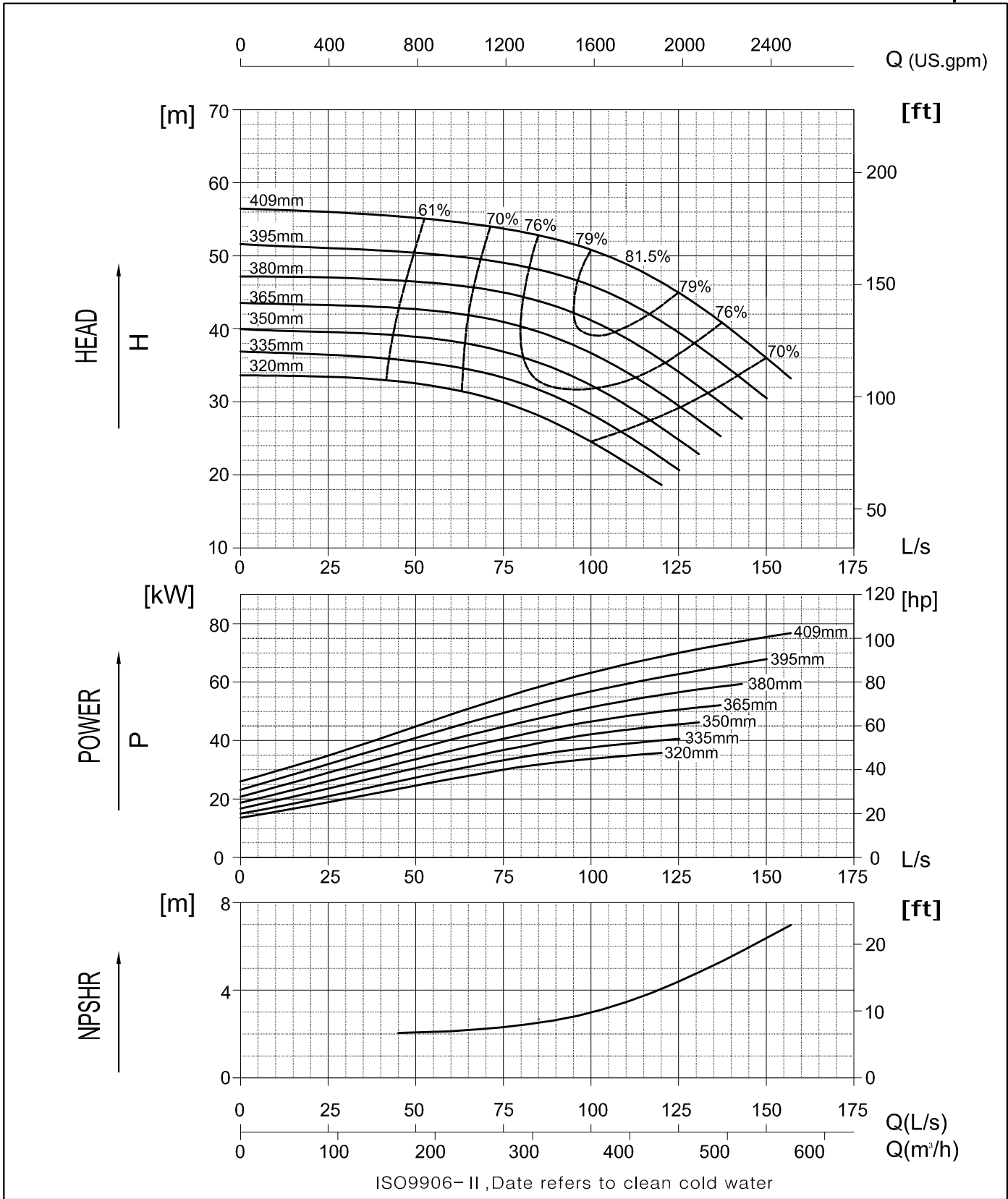

250-200-260

Performance Curve

1450 rpm

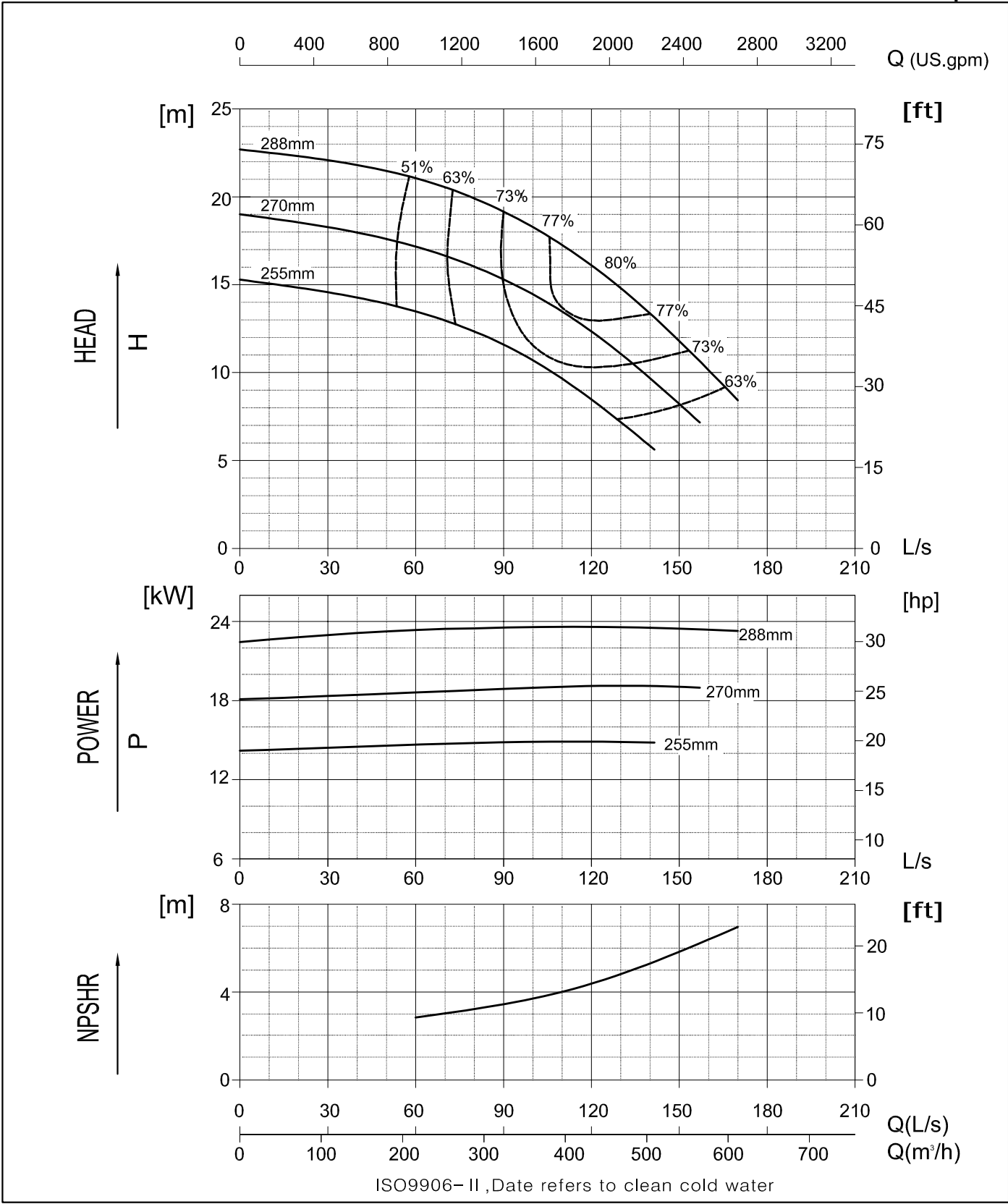

250-200-320

Performance Curve

1450 rpm

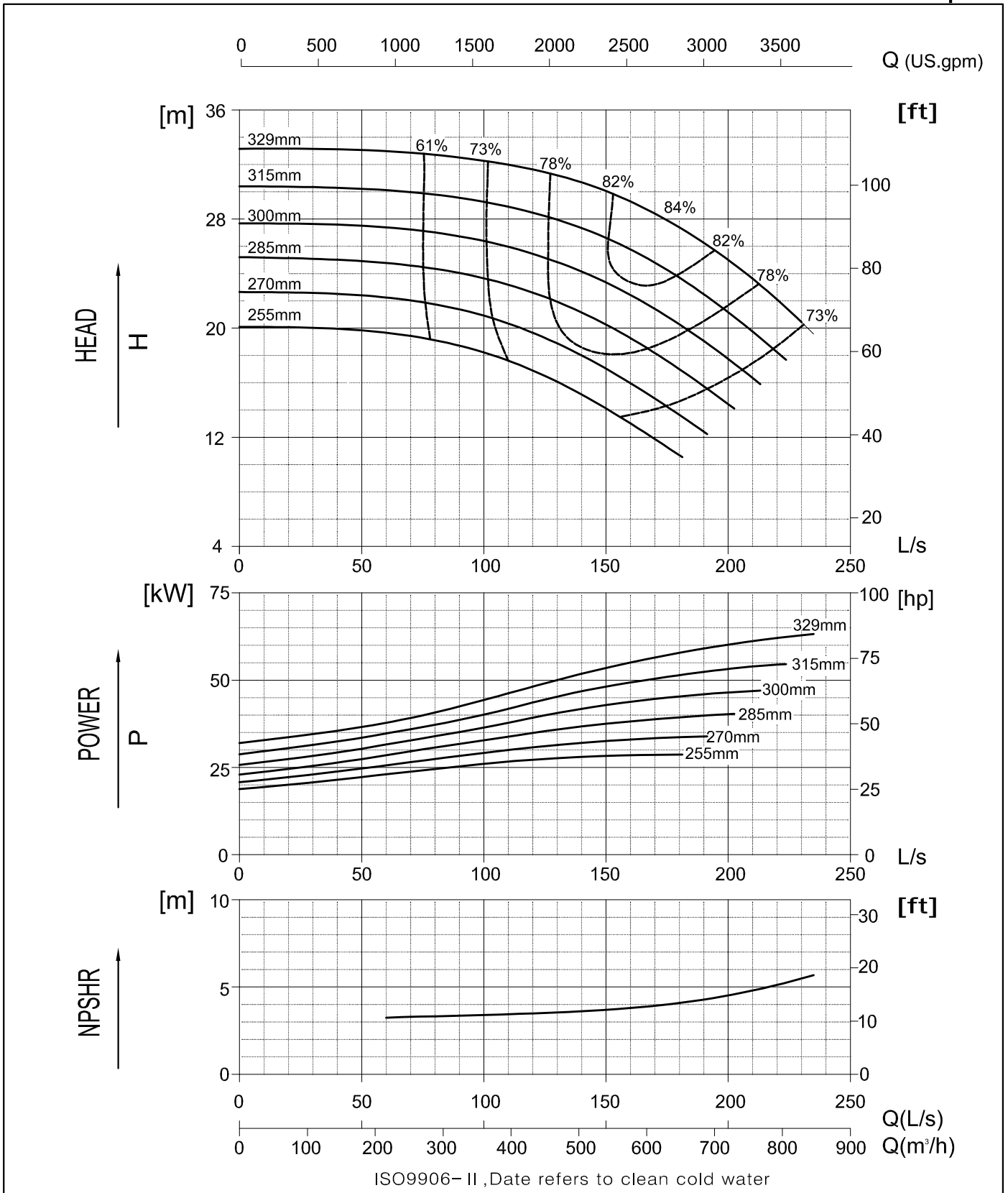

250-200-400

Performance Curve

1450 rpm

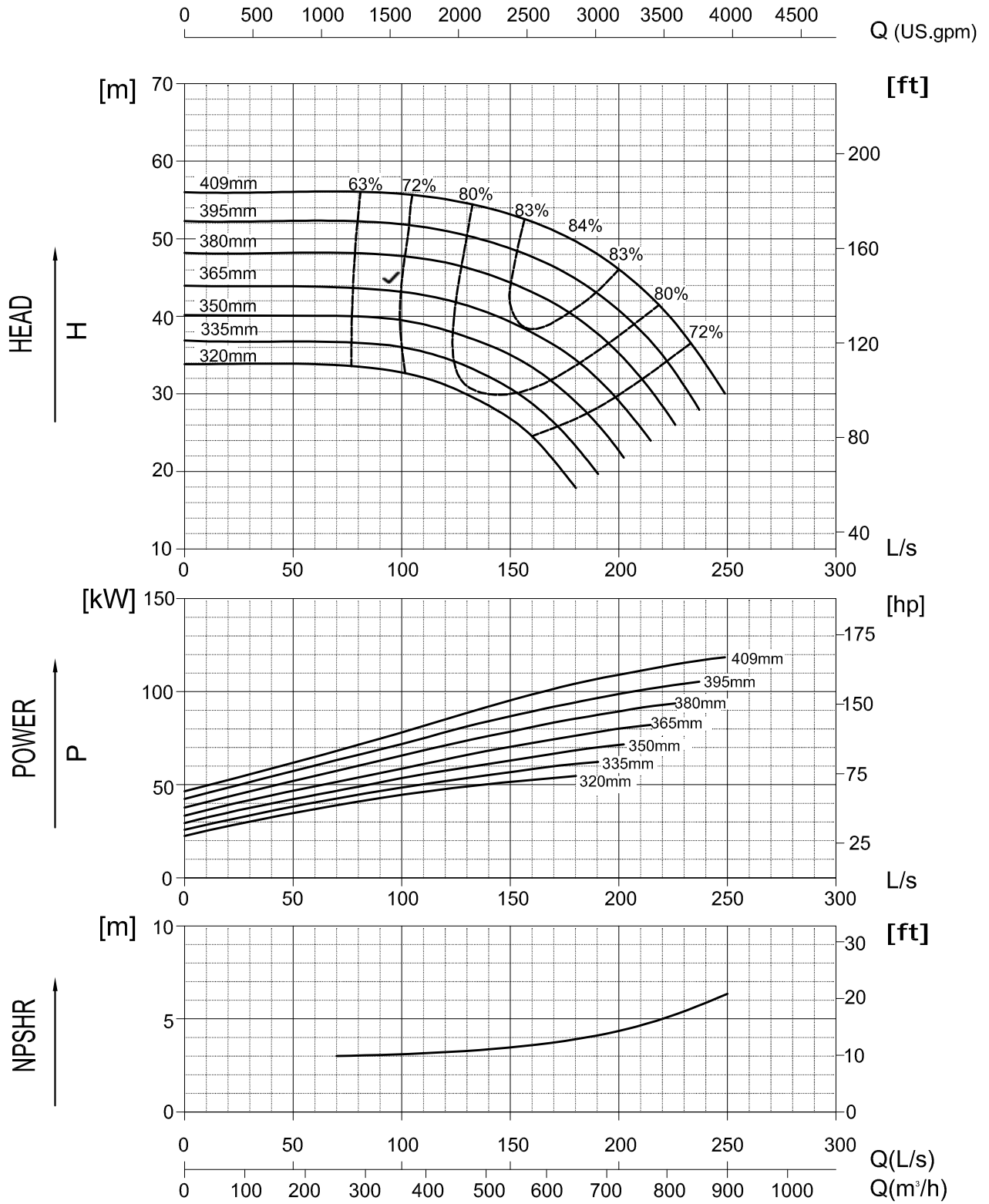

ISO9906-II, Date refers to clean cold water

300-250-320

Performance Curve

1450 rpm

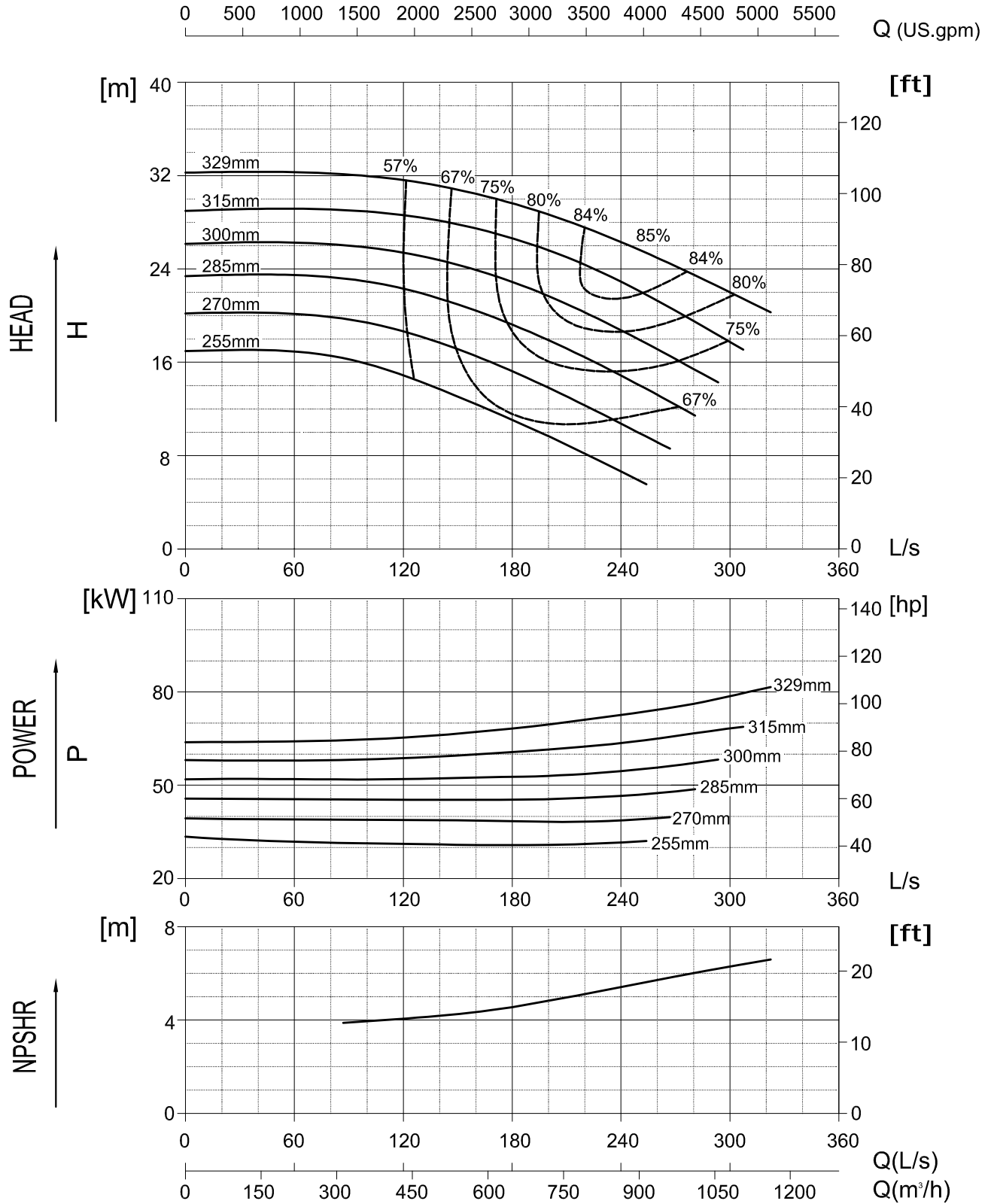

ISO9906-II, Date refers to clean cold water

300-250-400

Performance Curve

1450 rpm

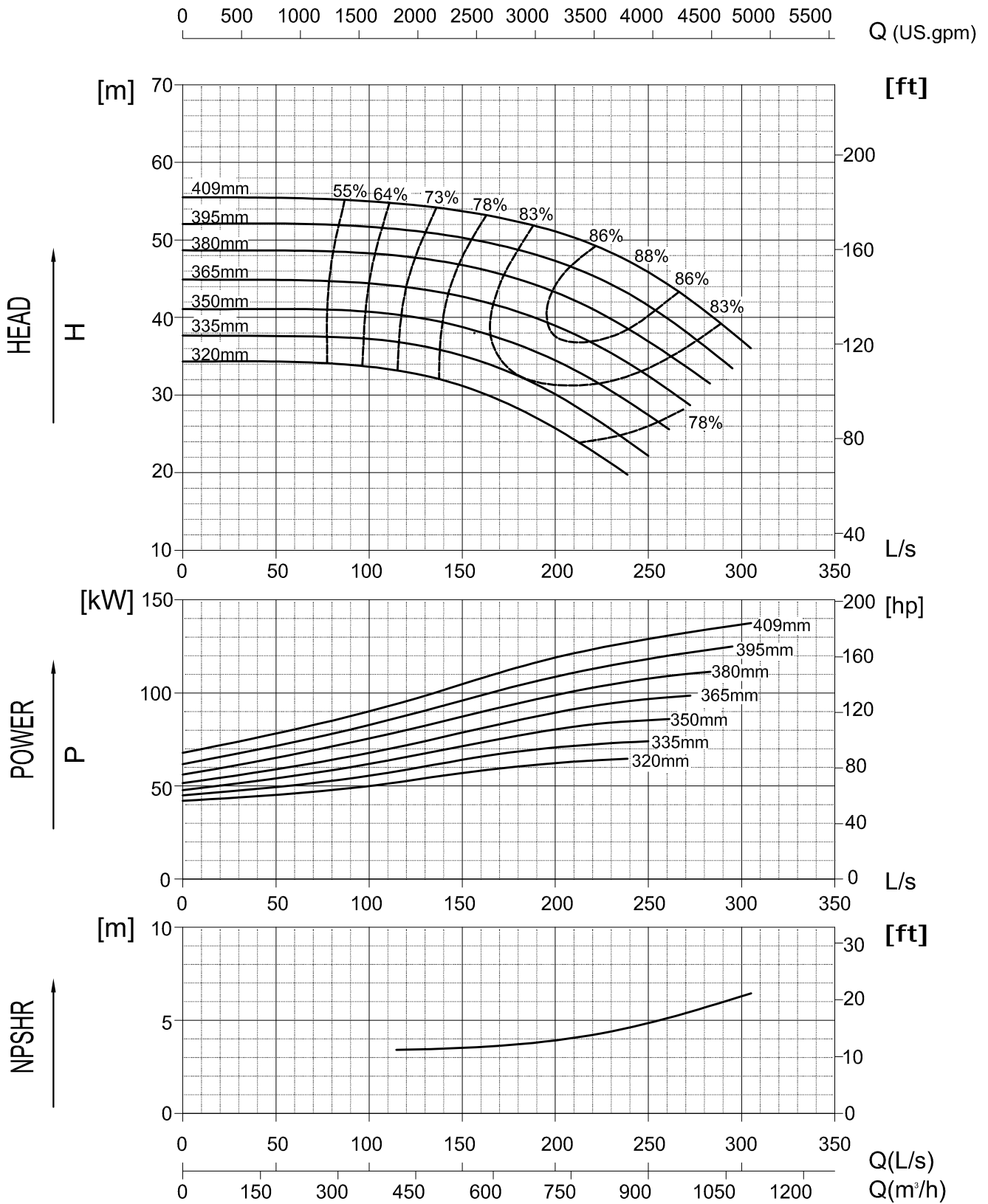

ISO9906-II, Date refers to clean cold water