

Main Office

SHANGHAI PUMPING TECH INTERNATIONAL CO.,LTD

Add:No.6 Building, No.2999 Hutai Av, Baoshan district ,
Shanghai,China

Email:Infor@aikonchina.com

Website:www.aikonchina.com
www.aikoncontrol.com



WQ

Submersible sewage pump



LINE OFFICIAL



MOSCOW Office

Add:Moscow, Volokolamsk highway, 73, office 210

Tel:+7-499-703-35-23 +7-800-333-10-74

Email:aikon@aikonrussia.ru

Website:www.aikonrussia.ru

THIANTHONG INDUSTRY (THAILAND) CO.,LTD

Website:www.energyhealth2002.com

Installation

Auto-Coupled installation

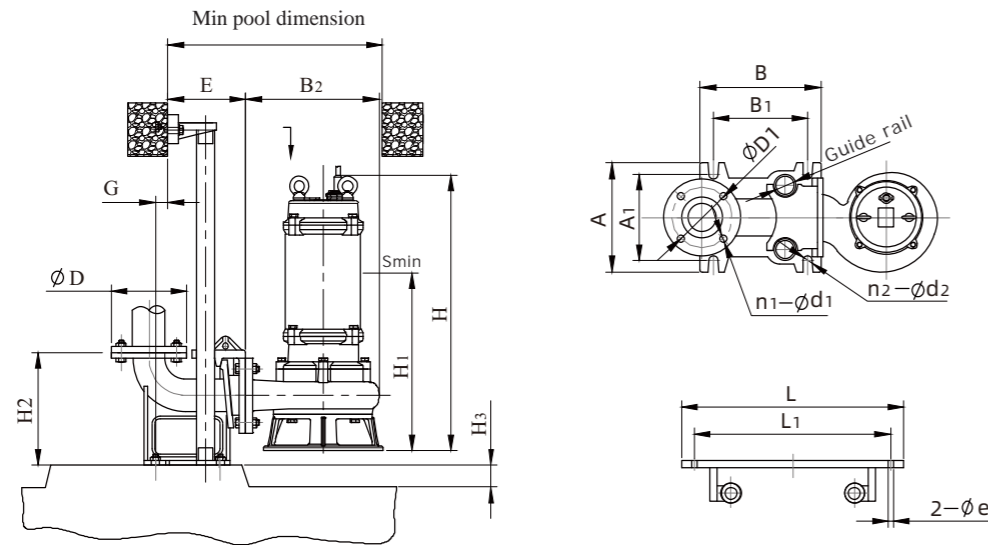

Movable pipe installation

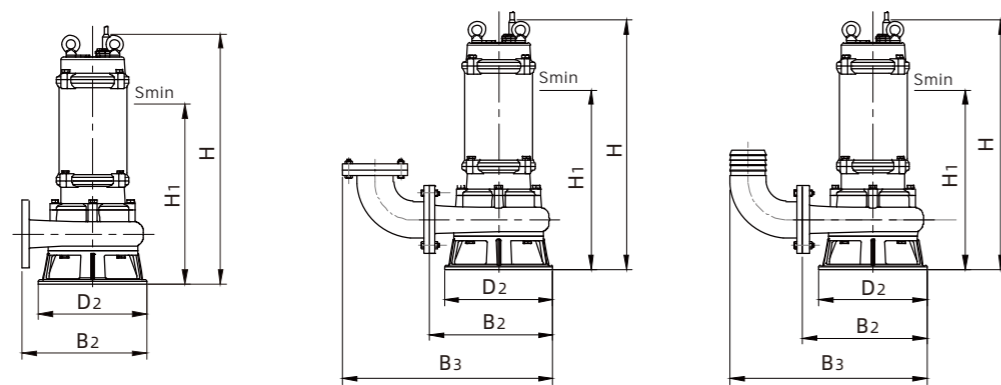

A、Hard pipe

B、Hard pipe(with double flange belt)

C、Soft pipe

Installation Dimensions

No.	Model	Flange PN0.6MPa mm			General duty auto-coupled dimension mm					G	H ₂	H ₃	L	L ₁	Guide rail Inch	ϕe	E
		D	D1	n1- $\phi d1$	A	A ₁	B	B ₁	n2- $\phi d2$								
1	DN50	140	110	4- $\phi 14$	132	115	160	118	4- $\phi 16$	23	210	160	265	220	1	12	145
2	DN65	160	130	4- $\phi 14$	160	140	185	135	4- $\phi 16$	25	246	165	275	240	1	12	158
3	DN80	190	150	4- $\phi 18$	185	160	220	160	4- $\phi 16$	30	280	165	315	266	1.5	12	188
4	DN100	210	170	4- $\phi 18$	210	175	260	196	4- $\phi 18$	46	335	185	360	305	1.5	12	205
5	DN150	265	225	8- $\phi 18$	260	230	340	252	4- $\phi 18$	92	415	200	465	400	1.5	16	245
No.	Model	Flange PN0.6MPa mm			Heavy duty auto-coupled dimension mm					G	H ₂	H ₃	L	L ₁	Guide rail Inch	ϕe	E
		D	D1	n1- $\phi d1$	A	A ₁	B	B ₁	n2- $\phi d2$								
1	DN50	140	110	4- $\phi 14$	160	140	210	166	4- $\phi 16$	72	210	160	265	220	1	12	145
2	DN65	160	130	4- $\phi 14$	200	175	235	185	4- $\phi 16$	73	245	165	275	240	1	12	155
3	DN80	190	150	4- $\phi 18$	230	195	270	210	4- $\phi 16$	80	280	165	315	266	1.5	12	188
4	DN100	210	170	4- $\phi 18$	270	230	320	256	4- $\phi 20$	110	335	185	360	305	1.5	12	212
5	DN150	265	225	8- $\phi 18$	320	260	486	370	4- $\phi 20$	234	415	200	465	400	1.5	16	240
6	DN200	320	280	8- $\phi 18$	390	350	626	490	4- $\phi 20$	361	444	200	530	465	1.5	16	245
No.	Model	Flange PN1.0MPa mm			Heavy duty auto-coupled dimension mm					G	H ₂	H ₃	L	L ₁	Guide rail Inch	ϕe	E
		D	D1	n1- $\phi d1$	A	A ₁	B	B ₁	n2- $\phi d2$								
1	DN250	395	350	12- $\phi 22$	480	420	666	480	4- $\phi 30$	330	500	200	595	525	2	16	300
2	DN300	445	400	12- $\phi 22$	560	500	760	570	4- $\phi 30$	423	600	250	630	560	2	16	300
3	DN350	505	460	16 \times $\phi 22$	620	560	860	660	4- $\phi 30$	503	700	250	630	560	2	16	321
4	DN400	565	515	16 \times $\phi 26$	700	620	980	750	4- $\phi 40$	559	800	300	680	610	3	16	377
5	DN500	670	620	20 \times $\phi 26$	840	760	1210	930	4- $\phi 40$	736	1000	300	777	707	3	24	408

Pump Main Material

Part name	Casing, Impeller	Motor casing	Shaft	Mechanical seal Friction material	
				Motor side	Pump side
Cast iron	HT200/QT600	HT200	45#/20Cr13	Graphite/SiC	graphite/SiC/WC
Stainless steel	304-316L	304-316L	45#/304-316L	Graphite/SiC	graphite/SiC/WC

OPTIONAL INNER FLANGE

WQ Sewage pump



Inner flange



Outlet elbow

Sectional drawing

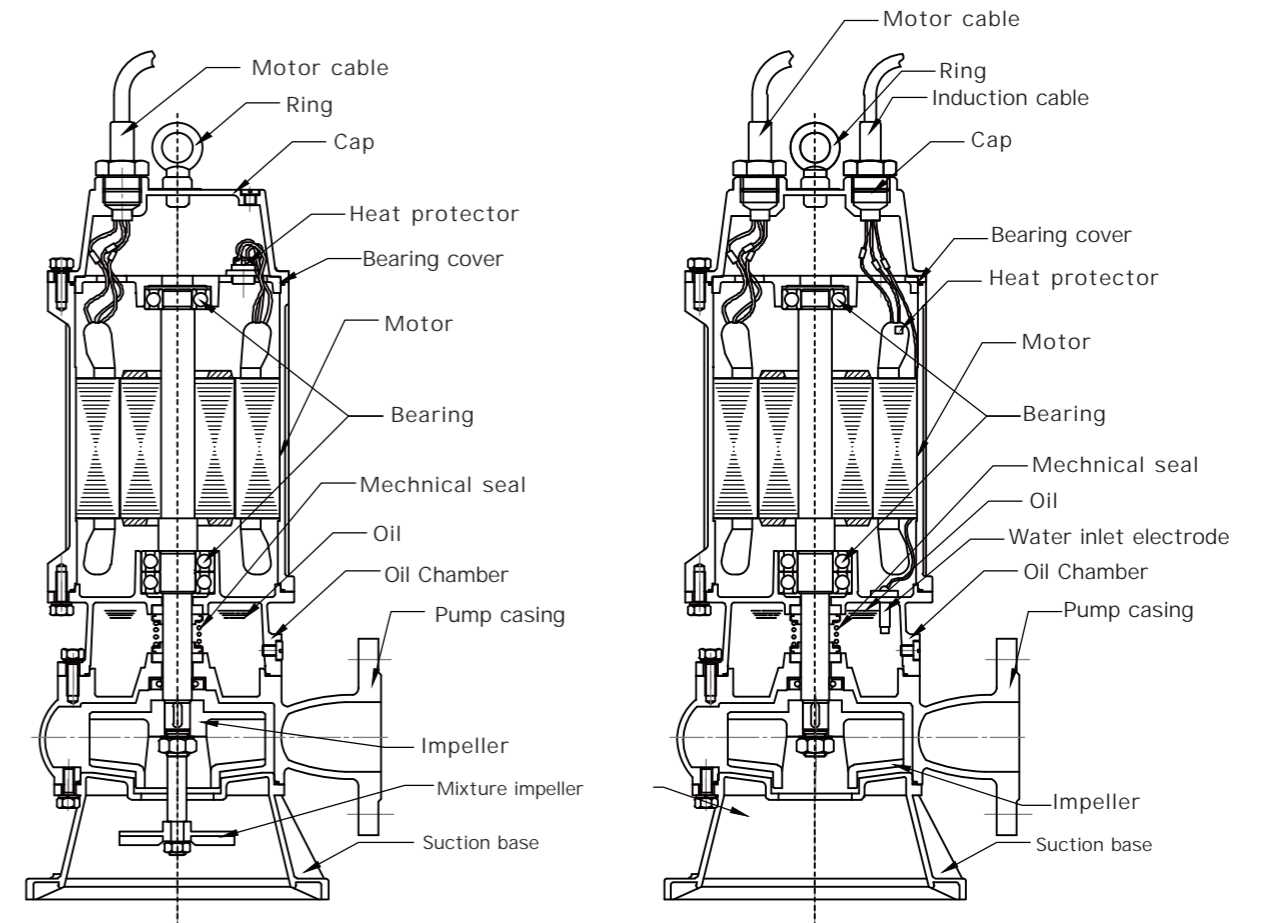

≤ 7.5KW

More than 11kW

Model Definition

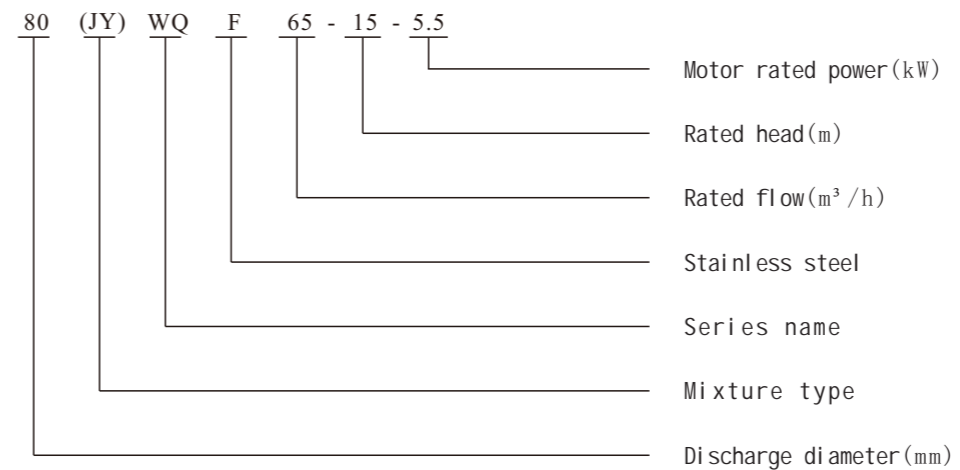

Technical Data

Di a mm	Model	Flow m ³ /h	Head m	Speed rpm	Motor kW	Di mensi ons Unit:mm				
						H	H ₁	H ₂	B ₂	B ₃
40	40WQ10-10-0.75	10	10	2900	0.75	400	300	93	217	312
	40WQ8-15-1.1	8	15	2900	1.1	415	315	93	217	312
	40WQ12-15-1.5	12	15	2900	1.5	493	370	103	250	345
50	50WQ10-10-0.75	10	10	2900	0.75	400	300	93	217	312
	50WQ15-8-1.1	15	8	2900	1.1	415	315	93	217	312
	50WQ8-15-1.1	8	15	2900	1.1	415	315	93	217	312
	50WQ15-10-1.5	15	10	2900	1.5	493	370	103	250	345
	50WQ10-15-1.5	10	15	2900	1.5	493	370	103	250	345
	50WQ15-15-2.2	15	15	2900	2.2	518	390	103	250	345
	50WQ25-10-2.2	25	10	2900	2.2	518	390	103	250	345
	50WQ9-22-2.2	9	22	2900	2.2	518	390	103	250	345
	50WQ20-18-2.2	20	18	2900	2.2	518	390	103	250	345
	50WQ15-20-2.2	15	20	2900	2.2	518	390	103	250	345
	50WQ20-25-3	20	25	2900	3	535	405	120	291	386
	50WQ15-25-3	15	30	2900	3	535	405	120	291	386
	50WQ15-32-4	15	35	2900	4	565	435	120	291	386
	50WQ15-40-5.5	15	40	2900	5.5	650	510	123	313	408
	50WQ20-30-5.5	20	30	2900	5.5	650	510	123	313	408
	50WQ20-40-7.5	20	40	2900	7.5	690	550	123	313	408
	50WQ25-35-7.5	25	35	2900	7.5	690	550	123	313	408
	50WQ20-50-11	20	50	2900	11	765	480	131	372	467
	50WQ20-70-15	20	70	2900	15	805	520	131	372	467
	50WQ20-80-18.5	20	80	2900	18.5	900	680	150	407	502
50WQ20-90-22	20	90	2900	22	950	700	150	407	502	
65	65WQ25-7-1.5	25	7	2900	1.5	493	370	103	250	345
	65WQ35-7-2.2	35	7	2900	2.2	518	390	103	250	345
	65WQ25-10-2.2	25	10	2900	2.2	518	390	103	250	345
	65WQ25-15-3	25	15	2900	3	535	405	120	291	386
	65WQ37-13-3	37	13	2900	3	535	405	120	291	386
	65WQ40-10-3	40	10	2900	3	535	405	120	291	386
	65WQ20-25-4	20	25	2900	4	535	405	120	291	386
	65WQ30-30-5.5	30	30	2900	5.5	650	510	123	313	408
	65WQ20-40-7.5	20	40	2900	7.5	650	510	123	313	408
	65WQ30-40-11	30	40	2900	11	765	480	131	372	467
	65WQ30-60-15	30	60	2900	15	805	520	131	372	467
	65WQ30-65-18.5	30	65	2900	18.5	900	680	150	407	502
	65WQ30-75-22	30	75	2900	22	950	700	150	407	502
80	80WQ45-9-2.2	45	9	2900	2.2	530	415	107	276	401
	80WQ40-12-3	40	12	2900	3	560	430	130	295	420
	80WQ40-15-4	40	15	2900	4	590	460	130	295	420
	80WQ50-10-4	50	10	2900	4	590	460	130	295	420
	80WQ65-15-5.5	65	15	2900	5.5	660	520	125	325	450
	80WQ40-22-5.5	40	22	2900	5.5	660	520	125	325	450
	80WQ40-30-7.5	40	30	2900	7.5	700	560	125	325	450
	80WQ80-13-5.5	80	13	1450	5.5	810	550	160	400	525
	80WQ80-20-7.5	80	20	1450	7.5	860	600	160	400	525
	80WQ60-30-11	60	30	2900	11	810	550	160	400	525
	80WQ60-40-15	60	40	2900	15	860	600	160	400	525
	80WQ60-45-18.5	60	45	2900	18.5	960	700	165	407	532
	80WQ60-50-22	60	50	2900	22	1010	780	165	407	532

Di a mm	Model	Flow m ³ /h	Head m	Speed rpm	Motor kW	Di mensi ons Unit:mm				
						H	H ₁	H ₂	B ₂	B ₃
100	100WQ40-8-2.2	40	8	2900	2.2	550	450	125	300	450
	100WQ50-7-2.2	50	7	2900	2.2	550	450	125	300	450
	100WQ60-9-3	60	9	2900	3	580	450	136	306	456
	100WQ65-10-4	65	10	2900	4	608	488	136	306	456
	100WQ65-15-5.5	65	15	2900	5.5	690	550	143	320	470
	100WQ65-20-7.5	65	20	2900	7.5	730	590	143	320	470
	100WQ100-10-5.5	100	10	2900	5.5	690	550	143	320	470
	100WQ100-15-7.5	100	15	2900	7.5	730	590	143	320	470
	100WQ110-10-5.5	110	10	1450	5.5	810	550	180	400	550
	100WQ100-15-7.5	100	15	1450	7.5	860	600	180	400	550
	100WQ80-25-11	80	25	2900	11	810	550	180	400	550
	100WQ80-35-15	80	35	2900	15	860	600	180	400	550
	100WQ100-25-11	100	25	1450	11	910	630	185	480	630
	100WQ100-30-15	100	30	1450	15	950	650	185	480	630
	100WQ80-40-18.5	80	40	2900	18.5	960	650	173	407	557
	100WQ80-45-22	80	45	2900	22	1001	680	173	407	557
	100WQ100-35-18.5	100	35	1450	18.5	1263	950	250	550	700
	100WQ100-40-22	100	40	1450	22	1290	980	250	550	700
	100WQ120-45-30	120	45	1450	30	1340	1000	272	602	752
	100WQ120-50-37	120	50	1450	37	1408	1050	272	602	752
100WQ100-57-45	100	57	1450	45	1490	1100	270	675	825	
100WQ100-65-55	100	65	1450	55	1622	1200	270	675	825	
100WQ120-75-75	120	75	1450	75	1520	1150	150	750	900	
100WQ120-85-90	120	85	1450	90	1630	1200	150	750	900	
100WQ130-90-110	130	90	1450	110	1760	1300	150	750	900	
150	150WQ100-7-5.5	100	7	2900	5.5	707	550	150	356	556
	150WQ145-9-7.5	145	9	2900	7.5	747	600	150	356	556
	150WQ100-10-7.5	100	10	2900	7.5	747	600	150	356	556
	150WQ100-20-11	100	20	2900	11	860	630	171	380	580
	150WQ120-15-11	120	15	2900	11	860	630	171	380	580
	150WQ100-30-15	100	30	2900	15	910	650	171	380	580
	150WQ120-25-15	120	25	2900	15	910	650	171	380	580
	150WQ180-11-11	180	11	1450	11	939	670	206	525	725
	150WQ180-15-15	180	15	1450	15	979	700	206	525	725
	150WQ100-36-18.5	100	36	2900	18.5	981	700	185	366	566
	150WQ100-40-22	100	40	2900	22	1011	730	185	366	566
	150WQ180-20-18.5	180	20	1450	18.5	1238	900	223	567	767
	150WQ250-15-18.5	250	15	1450	18.5	1238	900	223	567	767
	150WQ200-20-22	200	20	1450	22	1264	930	223	567	767
	150WQ180-30-30	180	30	1450	30	1300	1000	235	647	847
	150WQ200-30-37	200	30	1450	37	1368	1050	235	647	847
	150WQ200-35-45	200	35	1450	45	1453	1200	236	647	875
	150WQ200-45-55	200	45	1450	55	1622	1300	355	675	875
	150WQ200-55-75	200	55	1450	75	1609	1300	258	764	964
	150WQ200-60-90	200	60	1450	90	1684	1350	258	764	964
150WQ200-74-110	200	74	1450	110	1796	1400	245	732	932	
150WQ200-80-132	200	80	1450	132	1795	1400	203	884	1084	
150WQ300-95-160	300	95	1450	160	1795	1400	203	884	1084	
150WQ400-90-185	400	90	1450	185	1795	1400	203	884	1084	



Dia mm	Model	Flow m ³ /h	Head m	Speed rpm	Power kW	Dimensions					Unit:mm
						H	H ₁	H ₂	B ₂	B ₃	
200	200WQ220-6-7.5	220	6	1450	7.5	910	600	205	450	700	
	200WQ180-11-11	180	11	2900	11	890	600	185	430	680	
	200WQ180-15-15	180	15	2900	15	922	600	185	430	680	
	200WQ300-7-11	300	7	1450	11	979	650	206	525	775	
	200WQ250-11-15	250	11	1450	15	979	650	206	525	775	
	200WQ180-18-18.5	180	18	2900	18.5	974	600	185	424	674	
	200WQ200-20-22	200	20	2900	22	1004	650	185	424	674	
	200WQ300-12-18.5	300	12	1450	18.5	1238	900	223	567	817	
	200WQ300-15-22	300	15	1450	22	1264	930	223	567	817	
	200WQ250-22-30	250	22	1450	30	1321	1000	253	648	898	
	200WQ250-27-37	250	27	1450	37	1390	1050	253	648	898	
	200WQ350-23-37	350	23	1450	37	1390	1050	253	648	898	
	200WQ250-30-45	250	30	1450	45	1578	1250	353	650	900	
	200WQ360-26-45	360	26	1450	45	1578	1250	353	650	900	
	200WQ400-30-55	400	30	1450	55	1647	1300	353	650	900	
	200WQ350-45-75	350	45	1450	75	1609	1300	258	764	1014	
	200WQ300-53-90	300	53	1450	90	1684	1350	258	764	1014	
	200WQ380-50-90	380	50	1450	90	1684	1350	258	764	1014	
	200WQ320-65-110	320	65	1450	110	1814	1450	258	764	1014	
	250	200WQ400-75-132	400	75	1450	132	1795	1400	203	884	1134
200WQ360-90-160		360	90	1450	160	1795	1400	203	884	1134	
200WQ450-85-185		450	85	1450	185	1926	1520	203	884	1134	
250WQ400-5-11		400	5	1450	11	987	650	239	592	892	
250WQ400-6-15		400	6	1450	15	1028	700	239	592	892	
250WQ400-10-18.5		400	10	1450	18.5	1265	930	230	636	936	
250WQ500-9-22		500	9	1450	22	1291	1000	230	636	936	
250WQ500-12-30		500	12	1450	30	1349	1050	276	740	1040	
250WQ500-17-37		500	17	1450	37	1420	1100	276	740	1040	
250WQ600-15-45		600	15	1450	45	1504	1150	276	740	1040	
250WQ600-20-55		600	20	1450	55	1571	1200	243	710	1010	
250WQ600-26-75		600	26	1450	75	1647	1250	294	807	1107	
250WQ600-32-90		600	32	1450	90	1720	1350	294	807	1107	
250WQ600-38-110		600	38	1450	110	1852	1450	294	807	1107	
250WQ600-52-132		600	52	1450	132	1928	1520	309	890	1190	
250WQ600-60-160		600	60	1450	160	1928	1520	309	890	1190	
250WQ600-65-185		600	65	1450	185	2137	1730	387	970	1270	
300		300WQ650-5-18.5	650	5	1450	18.5	1294	1000	244	712	1062
	300WQ650-7-22	650	7	1450	22	1320	1000	244	712	1062	
	300WQ800-7-30	800	7	1450	30	1347	1050	243	712	1062	
	300WQ800-9-37	800	9	1450	37	1417	1120	243	712	1062	
	300WQ800-12-45	800	12	1450	45	1500	1200	243	712	1062	
	300WQ600-20-55	600	20	1450	55	1571	1250	243	712	1062	
	300WQ800-20-75	800	20	1450	75	1620	1300	243	760	1110	
	300WQ800-26-90	800	26	1450	90	1694	1350	243	760	1110	
	300WQ800-32-110	800	32	1450	110	1824	1450	243	760	1110	
	300WQ800-37-132	800	37	1450	132	1896	1500	243	865	1215	
	300WQ800-40-160	800	40	1450	160	1896	1500	243	865	1215	
	300WQ900-40-185	900	40	1450	185	2027	1600	243	865	1215	
	300WQ900-45-200	900	45	1450	200	2027	1600	243	865	1215	
	300WQ1000-45-250	1000	45	1450	250	2386	1950	376	1100	1450	
	300WQ1000-55-315	1000	55	1450	315	2415	2000	376	1100	1450	



Dia mm	Model	Flow m ³ /h	Head m	Speed rpm	Motor kW	Dimensions					Unit:mm
						H	H ₁	H ₂	B ₂	B ₃	
350	350WQ1000-6-30	1000	6	980	30	1500	1200	268	907	1307	
	350WQ1200-6-37	1200	6	980	37	1500	1200	268	907	1307	
	350WQ1200-8-45	1200	8	980	45	1584	1300	268	907	1307	
	350WQ1100-7-45	1100	7	1450	45	1554	1250	273	870	1270	
	350WQ1100-10-55	1100	10	1450	55	1623	1300	273	870	1270	
	350WQ1200-13-75	1200	13	1450	75	1685	1350	273	870	1270	
	350WQ1200-14-75	1200	14	980	75	1794	1450	273	1000	1400	
	350WQ1200-17-90	1200	17	980	90	1924	1550	273	1000	1400	
	350WQ1000-20-90	1000	20	1450	90	1752	1400	273	870	1270	
	350WQ800-32-110	800	32	1450	110	1932	1550	303	920	1320	
	350WQ1500-16-110	1500	16	980	110	1924	1550	273	1000	1400	
	350WQ1500-18-132	1500	18	980	132	2218	1800	411	1230	1630	
	350WQ1100-30-132	1100	30	1450	132	1924	1550	273	1000	1400	
	350WQ1500-26-160	1500	26	1450	160	1924	1550	273	1000	1400	
	350WQ1200-30-185	1200	30	1450	185	2055	1650	273	1000	1400	
	350WQ2000-20-200	2000	20	980	200	2258	1850	303	1190	1590	
	350WQ1500-35-250	1500	35	1450	250	2277	1850	273	1000	1400	
350WQ1500-45-315	1500	45	1450	315	2378	1950	273	1170	1570		
400	400WQ1000-8-37	1000	8	980	37	1529	1200	298	950	1400	
	400WQ1200-8-45	1200	8	980	45	1614	1300	298	950	1400	
	400WQ1300-8-55	1300	8	1450	55	1714	1350	303	920	1370	
	400WQ1200-10-55	1200	10	980	55	1683	1350	298	1000	1450	
	400WQ1500-10-75	1500	10	980	75	1824	1450	303	1025	1475	
	400WQ1500-16-90	1500	16	980	90	1954	1550	303	1025	1475	
	400WQ1600-15-110	1600	15	980	110	1954	1550	303	1025	1475	
	400WQ2000-13-132	2000	13	980	132	2135	1800	303	1216	1666	
	400WQ2000-18-160	2000	18	980	160	2135	1800	303	1216	1666	
	400WQ1500-22-160	1500	22	1450	160	1954	1550	303	1025	1475	
	400WQ1600-25-185	1600	25	1450	185	2085	1650	303	1025	1475	
	400WQ2000-20-185	2000	20	980	185	2143	1800	302	1206	1656	
500	400WQ2000-22-200	2000	22	980	200	2258	1850	303	1191	1641	
	400WQ2000-28-250	2000	28	980	250	2496	2100	322	1300	1750	
	400WQ1500-35-250	1500	35	1450	250	2311	1900	303	1025	1475	
	400WQ2000-36-315	2000	36	1450	315	2311	1900	303	1025	1475	
	500WQ2200-5-55	2200	5	980	55	1796	1450	355	1190	1740	
	500WQ2000-8-75	2000	8	980	75	1871	1500	355	1190	1740	
	500WQ1800-12-90	1800	12	980	90	2001	1600	355	1190	1740	
	500WQ2500-10-110	2500	10	740	110	2166	1800	355	1375	1925	
	500WQ2500-12-132	2500	12	740	132	2544	2100	355	1425	1975	
	500WQ2500-13-160	2500	13	980	160	2187	1800	335	1246	1796	
600	500WQ2500-18-185	2500	18	740	185	2604	2200	355	1425	1975	
	500WQ2500-15-185	2500	15	980	185	2336	1900	355	1375	1925	
	500WQ2500-18-200	2500	18	980	200	2336	1900	355	1375	1925	
	500WQ3000-18-250	3000	18	980	250	2544	2100	355	1425	1975	
	500WQ3500-25-315	3500	25	980	315	2604	2200	355	1425	1975	
	600WQ3100-7.5-132	3100	7.5	740	132	2251	1850	410	1590	2240	
	600WQ3300-10-160	3300	10	740	160	2544	2100	355	1425	2075	
	600WQ2500-14-185	2500	14	980	185	2518	2100	410	1276	1926	
	600WQ2500-16-200	2500	16	980	200	2518	2100	410	1276	1926	
	600WQ3200-13-200	3200	13	980	200	2518	2100	410	1276	1926	
600	600WQ4000-18-250	4000	18	980	250	2544	2100	355	1425	2075	
	600WQ4500-20-315	4500	20	980	315	2421	2000	410	1590	2240	

Model	Q(m³/h)	5	10	15	20	25	30	35	40	45	50	55
50WQ10-10-0.75	H (m)	12.7	10	6	2							
50WQ15-8-1.1		10.5	9.2	8	6	2						
50WQ8-15-1.1		16.1	14	12	8							
50WQ15-10-1.1		13.5	12	10	8	5						
50WQ10-15-1.5		19	15	8								
50WQ15-15-1.5		18	16.5	15	12.5	10						
50WQ25-10-2.2			15	13.3	12	10	7.5	4				
50WQ9-22-2.2		26	20.5	13								
50WQ15-20-2.2		27	23.7	20	13.4							
50WQ15-25-3		27	25	24	21	19						
50WQ15-32-4		38	35.2	32	24							
50WQ15-40-5.5		46.5	43.3	40	32							
50WQ20-30-5.5		34.2	33.7	32.2	30	27	23					
50WQ20-40-7.5		44	43.4	42	40	37	32.5					
50WQ20-50-11		60	57	54	50	45	30					
50WQ20-70-15		77	75.5	73	70	67	64	58	52			
65WQ25-7-1.5		12	11	9.8	8.2	7	5	3				
65WQ35-9-2.2		18	17	15.5	14.5	13	11	9	7	3		
65WQ25-14-2.2		20	18.8	17	16.2	14	12	7				
65WQ25-18-3			22	20.5	19.5	18	16	13.5	11	7		
65WQ37-13-3					20	19	17	14	12	10		
65WQ40-12-3					20	19	17	14	12	10		
65WQ20-25-4		29	28.5	27	25	22	17.8					
65WQ30-30-5.5				36	35	32.6	30	27	23.5	20		
65WQ20-40-7.5		44	43.4	42	40	37	32.5					
65WQ20-50-11		60	57	54	50	45	30					

Model	Q(m³/h)	20	30	40	50	60	70	80	90	100	110	120
80WQ45-9-2.2	H (m)	13.5	12	10	7.5	5						
80WQ40-12-3		17	15	12	11	9						
80WQ40-15-4		21.5	18	14.5	9.5	3						
80WQ50-10-4		18	16.5	13	10	6	1.5					
80WQ40-22-5.5		28	26	21.2	16.5	10						
80WQ40-30-7.5		38	34	30	25	19						
80WQ60-30-11		40	37	35	33	30	27	23				
80WQ60-40-15		50	47	45	43	40	37	34				
100WQ40-8-2.2		12	10	8	5.5	3						
100WQ50-7-2.2		13.8	12.5	10	7	3						
100WQ60-9-3		15.2	14	12.8	11.3	9	7	4				
100WQ65-10-4		16	14.8	13	11.5	10	7	5.5				
100WQ65-15-5.5		22	21	19	17.5	16	14	11.2	8.8			
100WQ65-20-7.5		28.5	27.5	26	23.7	21.5	19	15	11.5			

Model	Q(m³/h)	20	40	60	80	100	120	140	160	180	200	220
100WQ100-15-7.5	H (m)			19	17.5	15	12					
100WQ80-25-11			32	29	25	22	18					
100WQ80-30-15		34	33	31.5	30	27.5	23	18				
100WQ100-30-15		35	34	33	31.5	30	27.5	23.5	19			
100WQ80-35-18.5			43	40	35	28.7						
100WQ100-35-18.5				39	37.8	35	31.5					
150WQ100-7-5.5			11	9.5	8.5	7	5.2	3				
150WQ145-9-7.5					13.6	12.5	11.2	10	7.5	5.2		
150WQ100-10-7.5				14	12.5	10	7	3				

Model	Q(m³/h)	80	100	120	140	160	180	200	220	240	260	280	
150WQ180-11-11	H (m)	17	16.5	15.5	14.5	13	11	10.2	8.5	6.5	4.5		
150WQ180-15-15				20.5	19.5	18.2	17	15	14	13	11	9	
150WQ180-20-18.5				23	22.4	21.5	21	20	19.3	18.4	17.5	16.5	13.6
150WQ250-15-18.5					22	21	20	19	18	17	15.7	14.5	13.3
150WQ200-20-22				25.5	25	24	23	21.5	20	19	18	17	16
150WQ200-25-30		31	30	29	28	27	26	25	23	21.5	20		
150WQ200-30-37			35	34	33	32	31	30	29	27.5	26.5	24	
150WQ200-35-45		42	41	39	38	37	36	35	34	32.5	31.5	30	
150WQ200-45-55		52	51	49	48	47	46	45	43.5	42	40.5	39	
150WQ200-55-75		61	60	59	58	57	56	55	53	51.5	50.5	48	
150WQ200-60-90		67	66	65	64	63	61.5	60	58	57	55	53	
150WQ200-74-110		82	80.5	79	77.5	76	75	74	72	70	68	66	
150WQ200-80-132		86	85	84	83	82	81	80	79	78	77	76	
200WQ220-6-7.5		12	11.5	11	10.5	10	8.5	7.5	6	4.5	3	2	

Model	Q(m³/h)	150	200	250	300	350	400	450	500	550	600	650
200WQ300-7-11	H (m)	15	13	10	7	3						
200WQ250-11-15		16	14	11	7	2						
200WQ300-12-18.5		18	16	14	12	8	5					
200WQ300-15-22		23	20	18	15	12	10	3				
200WQ250-22-30		25.5	24	22	20	18	15	11				
200WQ300-20-30		25.5	24	22	20	18	15	11	4			
200WQ300-25-37			28.5	27	25	23	20.5	17.5	8			
200WQ300-28-45		33	31.5	30	28	26	24	20	7.5			
200WQ300-37-55		42	41	39	37	34.5	32	20				
200WQ350-40-75		49	47	45	43	40	35	25				
200WQ300-53-90		58	56.5	55	53	51	48	20				
200WQ300-65-110		72	70	67.5	65	62.5	58.5	31				
200WQ400-75-132		87	84.5	82	79.5	77.5	75	70	64			
200WQ300-95-160		100	99	97	95	92	85.5					
200WQ450-85-185		100	98	96	94	91	88	85	80	75	69	
250WQ400-6-15		12	11	10	9	7.5	6	4.8	3.5	1.5		
250WQ400-10-18.5		15.5	14.5	13.5	12.5	11.2	10	8	6	2.5		
250WQ500-9-22		18.5	17.5	16.5	15.5	14	12.5	11	9	8	6	4

Model	Q(m³/h)	200	300	400	500	600	700	800	900	1000	1100	1200	
250WQ600-9-30	H (m)	17.5	16.5	14.5	12.5	9	5.5						
250WQ600-12-37		20	19	17	15	12	5.8						
250WQ600-15-45		24	22.5	21	19.5	15	10.8						
250WQ600-20-55		27	26	24.8	23	20	14	3					
250WQ600-26-75		34	32	30	28.5	26	24	17					
250WQ500-34-90		39	37.5	36	34	32	18	2					
250WQ600-38-110		45	43	41	39.5	38	35	33	29	24			
250WQ600-50-132		58	56	54	52	50	45	30					
250WQ600-60-160		70	67.5	65	62.5	60	56						
250WQ600-65-185		72.5	72	70	68	65	62	27					
300WQ800-9-37		23	21	19	16	13.5	11.5	9	6.2	2			
300WQ800-12-45			24	23	20.5	18	15	12	9	4			
300WQ600-20-55			24.5	23	21.3	20	18	15	11	8			
300WQ800-20-75		30.5	29	27.5	25.8	22.4	22	20	17	14	8		
300WQ800-26-90		37	35.5	33.8	32	30	28	26	22.5	16	3		
300W800-32-110		44	42.5	41	40	39.5	35.5	32	29.5	27	22		
300W800-37-132		47	46	45	43	41	39	37	33	29	18		
300W800-40-160		52	51	50	47.5	45	42.5	40	36	32	22		
300W900-40-185		58	55	52.5	50.5	48	45	42.5	40	37	12		
300W900-45-200		63	60	57.5	55.5	53	50	47.5	45	42	17		
350WQ1000-6-30					11	10	9	8	7	6	5	3.5	

Model	Q(m³/h)	700	800	900	1000	1100	1200	1300	1400	1500	1600	1700
350WQ1200-6-37	H (m)	11	10	9	8	7	6	4.5	2.5			
350WQ1100-7-45		14	13	11	9	7	5	2.5				
350WQ1200-8-45		13.5	12.7	12	11	9.5	8	6	4.5	2.3		
350WQ1100-10-55		15.5	14.5	13	11.8	10	8	6	3.8	2		
350WQ1200-13-75		22.5	21	19.3	17.5	15.5	13	7.5				
350WQ1200-17-90		22.1	21.5	21	19.7	18.3	17	15.5	14	12	10	
350WQ1500-16-110		21	20	19.5	19	18.5	18	17.5	16.7	16	15	14
350WQ1100-30-132		36	34.8	33.3	32	30	27	18.5				
350WQ1500-18-132			22	21.5	21	20.5	20	19	18.5	18	17	16
350WQ1500-26-160			34.7	33.5	32.5	31.5	30	28.7	27.5	26	24.7	23.5
350WQ1200-30-185		37.5	36.8	35	33	31.5	30	28	24	18		
400WQ1000-8-37		11	10	9	8	6.8	5.5	4.3	3	1.5		
400WQ1200-8-45		13.5	12.7	12	11	9.5	8	6	4.5	2.3		
400WQ1200-10-55		15.5	14.7	14	13	11.5	10	8	6.5	4.5		
400WQ1500-10-75		18.5	17.5	16.8	15.5	14.5	14	12.2	11	10	8	

Model	Q(m³/h)	900	1050	1200	1350	1500	1650	1800	1950	2100	2250	2400
400WQ1200-15-75	H (m)	17	16	15	12.6	10.7	9	5				
400WQ1500-16-90			21.5	19.5	18	16	13.5	3.5				
400WQ1600-15-110				16.7	16	15.3	14.7	13.4	12	10	8	6
400WQ2000-13-132		22	21	20	19	18	16.5	15	13.3	12	10.5	9
400WQ1500-22-160		31	28.8	26.5	24	22	19.5	10				
400WQ2000-18-160			25	24.5	23.5	22.5	21.6	20.2	18.7	16.8	15.5	8.5
400WQ2000-20-185		30.5	29.5	28.4	27.5	25.5	24	22	20.3	19.5	18	15
400WQ2000-22-200		32	31	30	29	28	26.5	25	23.5	22	20	18
400WQ1500-35-250		44	42	40	37.5	35	32	25				

型号	Q(m³/h)	700	1000	1300	1600	1900	2200	2500	2800	3100	3400	3700
500WQ1800-12-90	H (m)	18.5	17	15.5	13.5	11.3	8.8	6	3			
500WQ2500-10-110		16	15.2	14.2	13.2	12.2	11.2	10	8.7	7.1	6	4.5
500WQ2500-12-132		24	23	21	18.8	17	14.5	12	9	7	2	
500WQ2500-13-160		26	24.4	22.5	20.5	18	15.6	13	10	7	3	
500WQ2500-14-185		23.5	22	20.5	19	17.5	15.8	14	12	9.5	7	4
500WQ2500-16-200		25.5	24	22.5	21	19.5	17.8	16	14	11.5	9	6
500WQ2500-18-185		25.5	24.5	23.8	22.5	21	19.5	18	16	13.5	10.5	7.5

型号	Q(m³/h)	800	1200	1600	2000	2400	2800	3200	3600	4000	4400	4800
600WQ2500-14-185	H (m)	23	21	19	17	15	12	8	4			
600WQ2500-16-200		25	23	21	19	17	14	10.5	6			
600WQ3200-13-185		26	25	23	21	18.8	16	13	9	5		

Curve

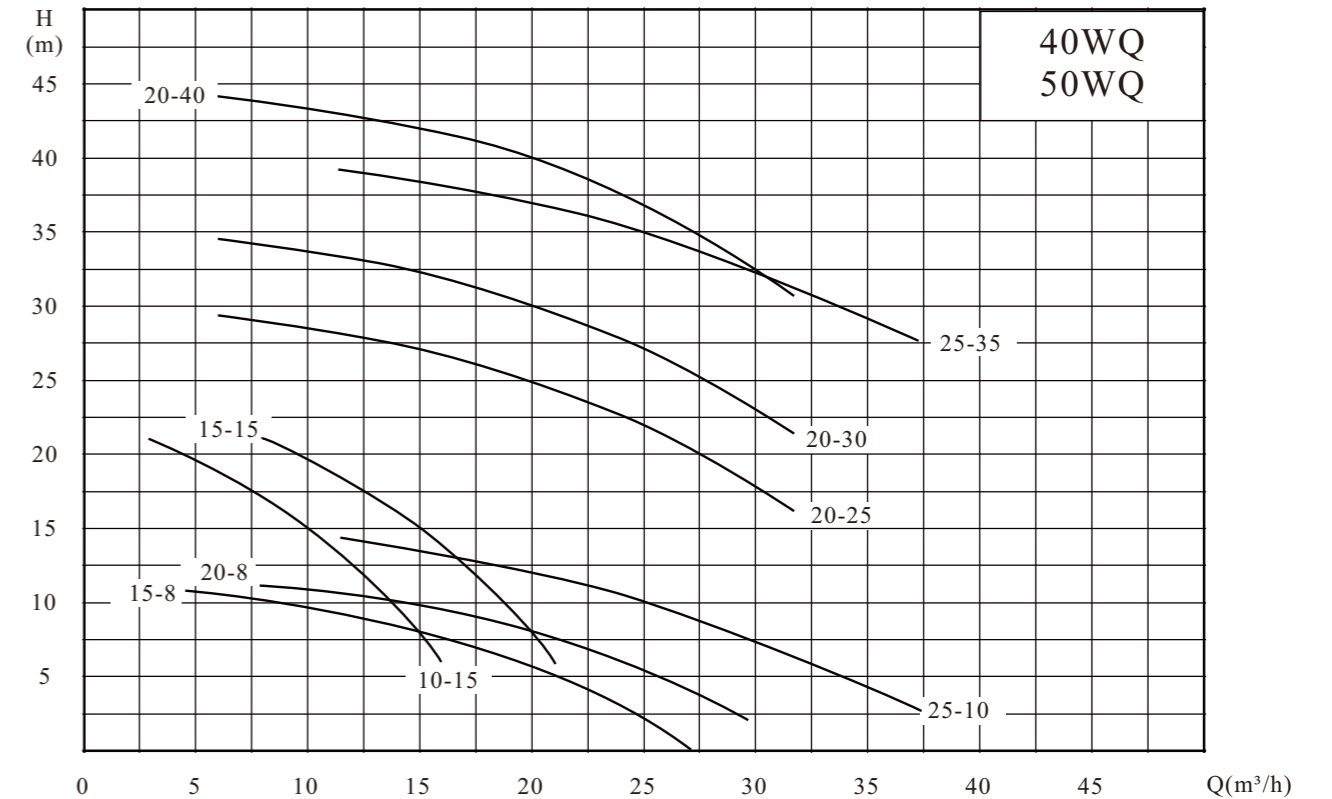
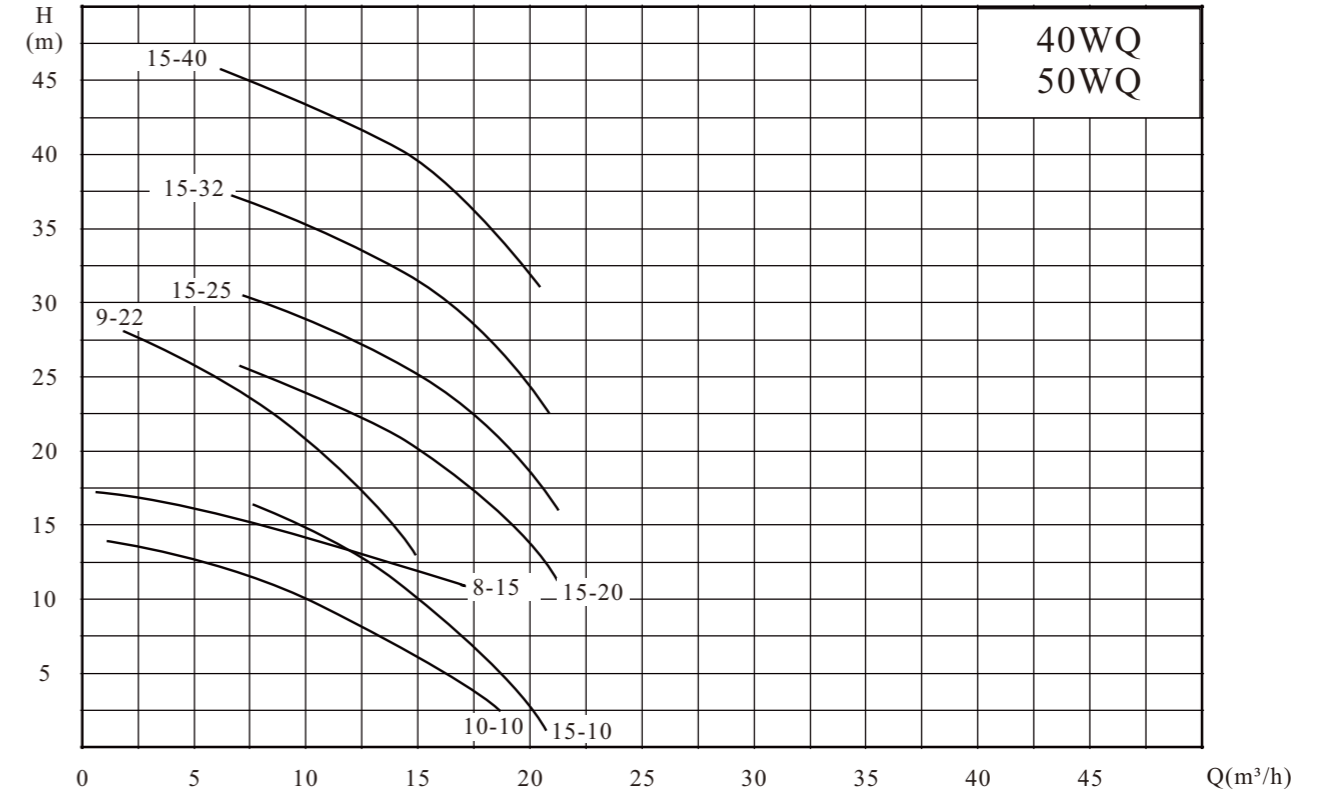

Curve

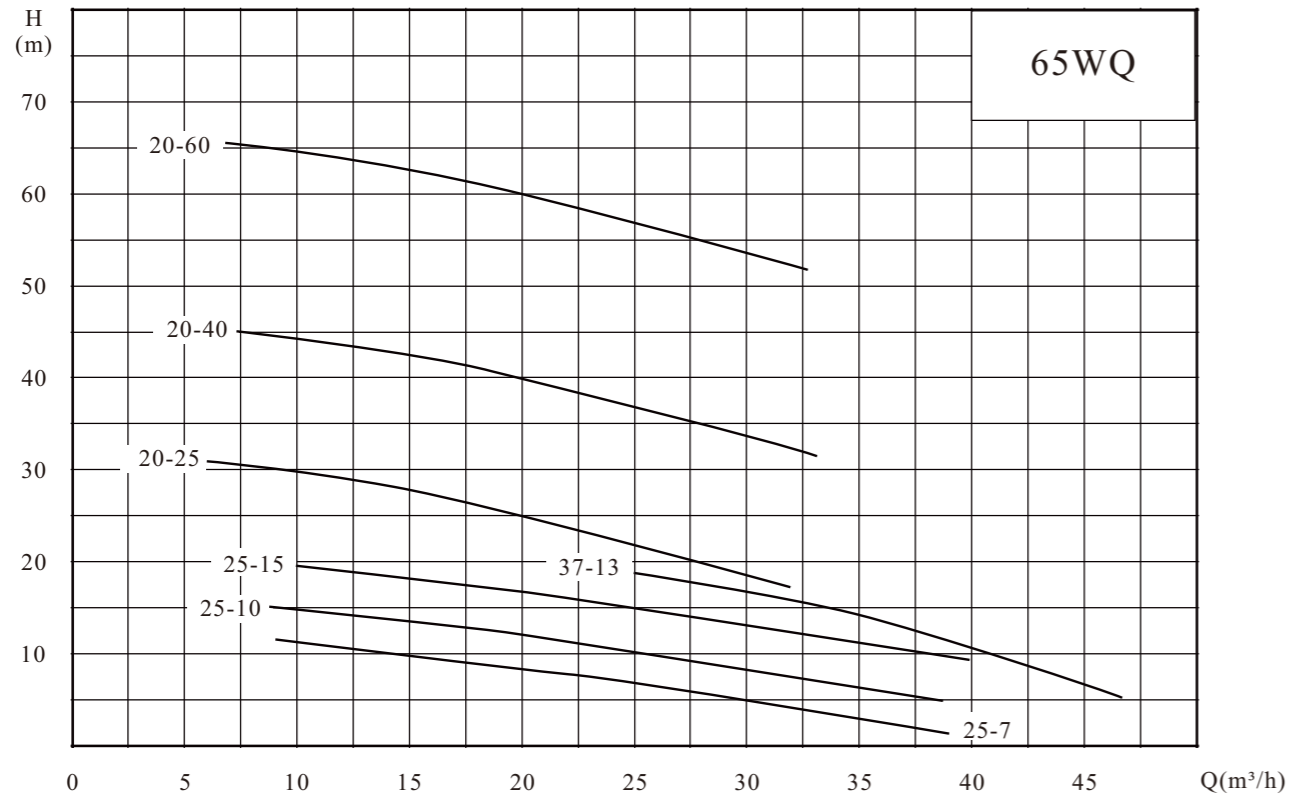

Curve

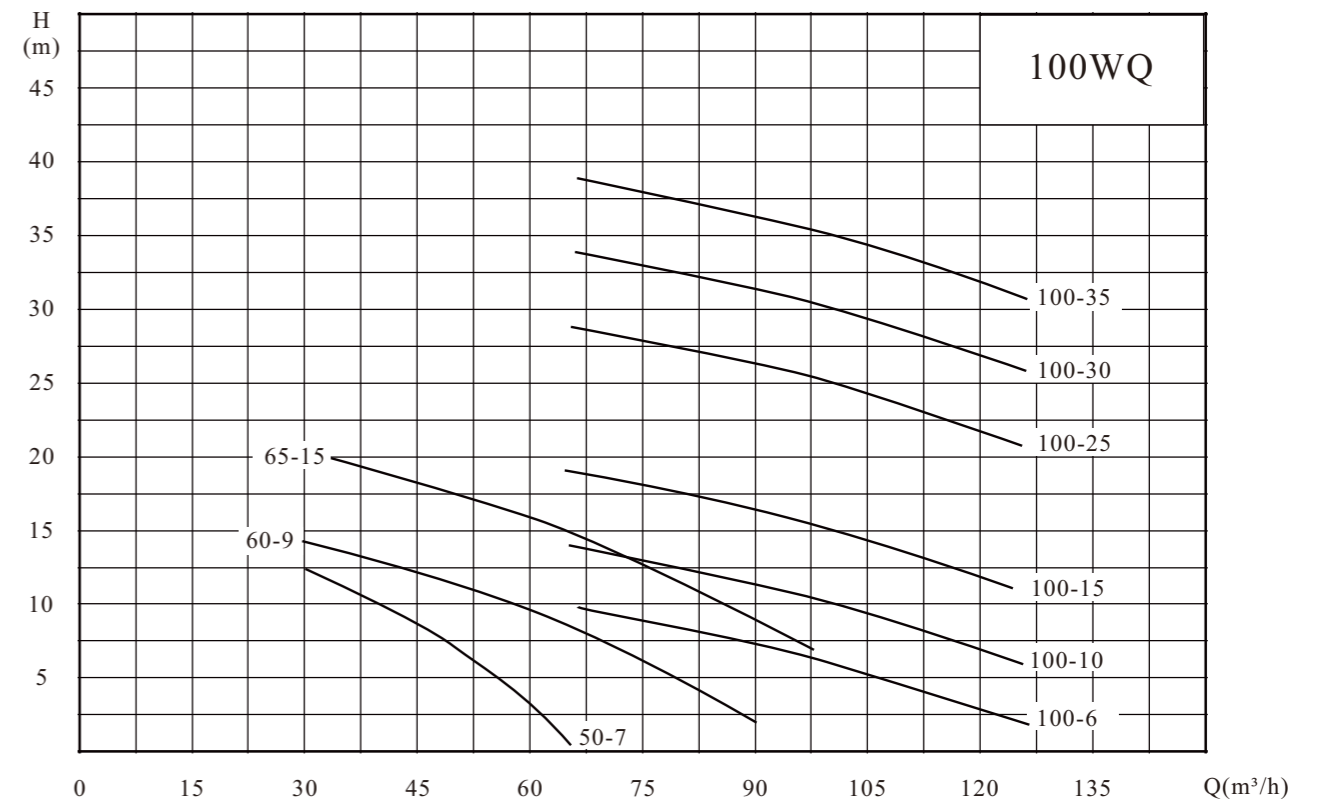
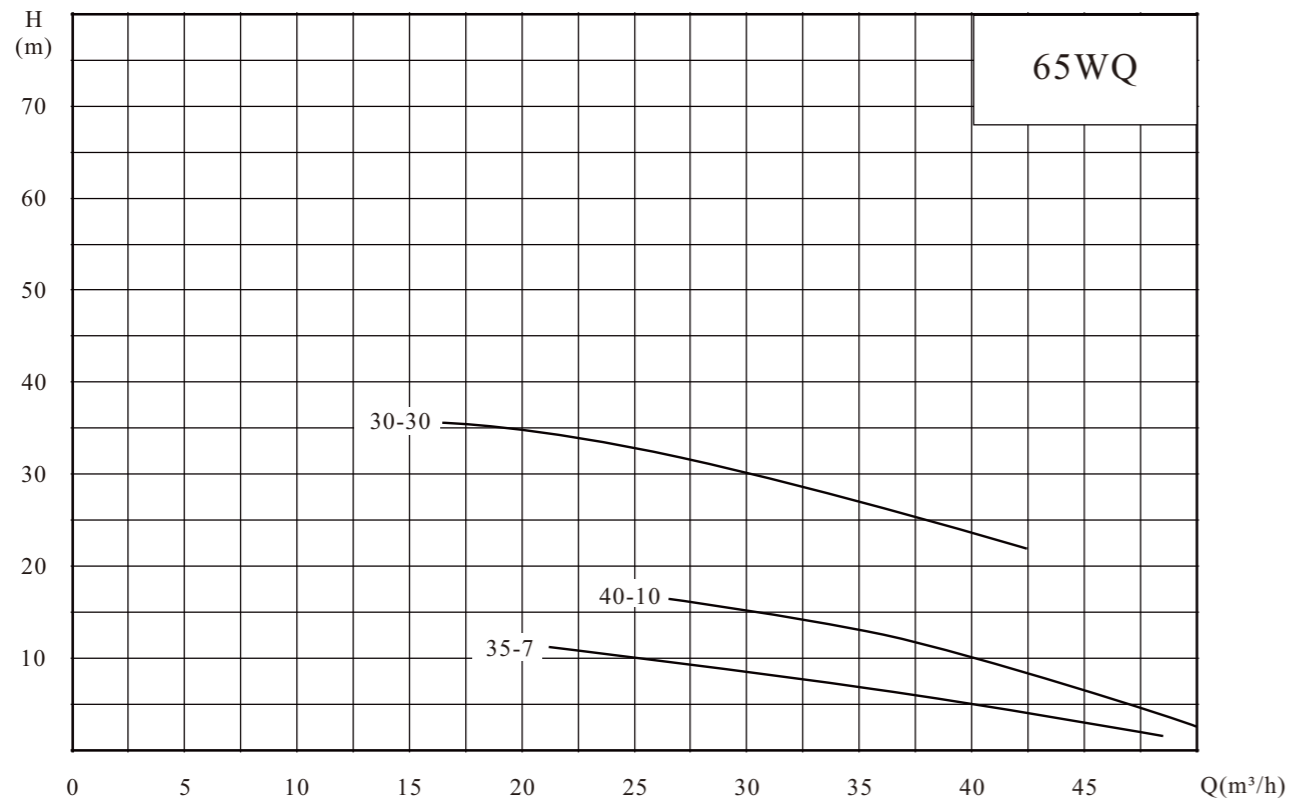
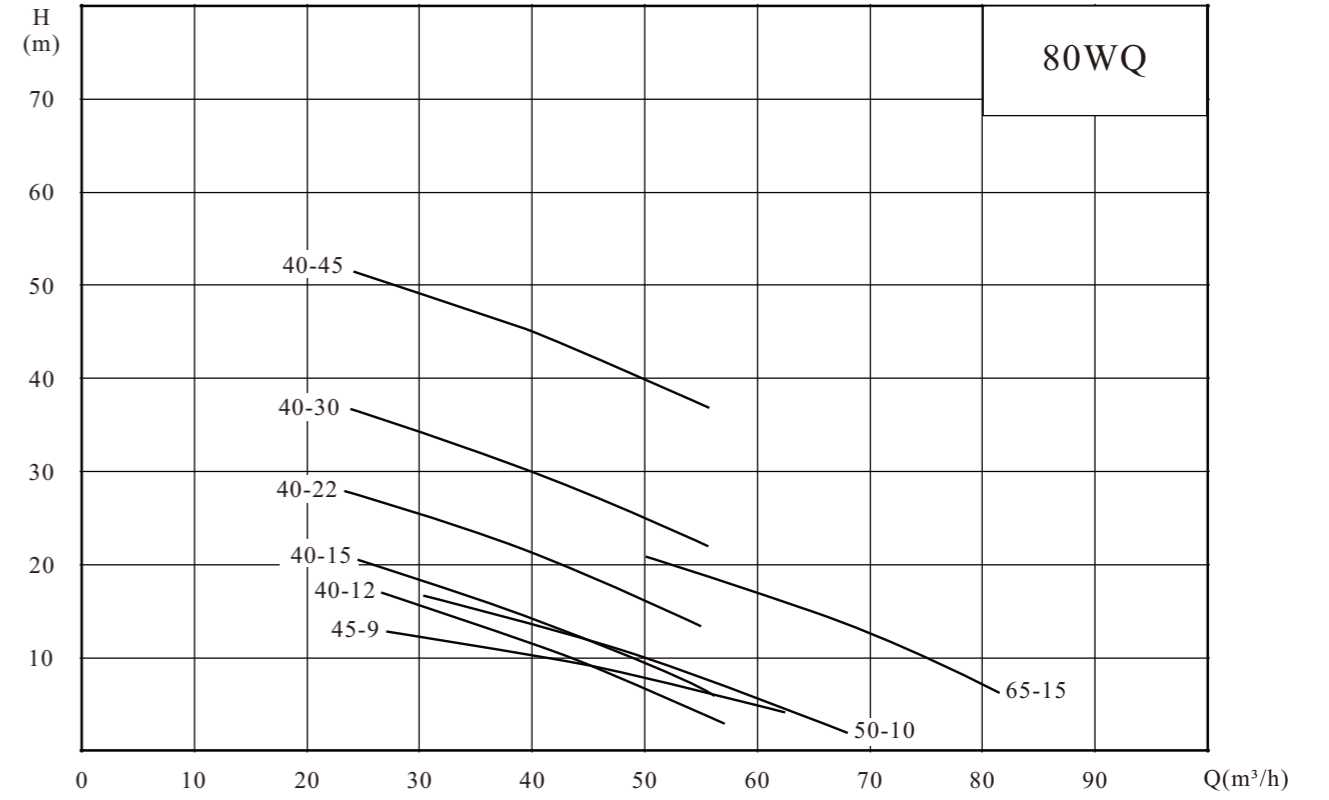

Curve

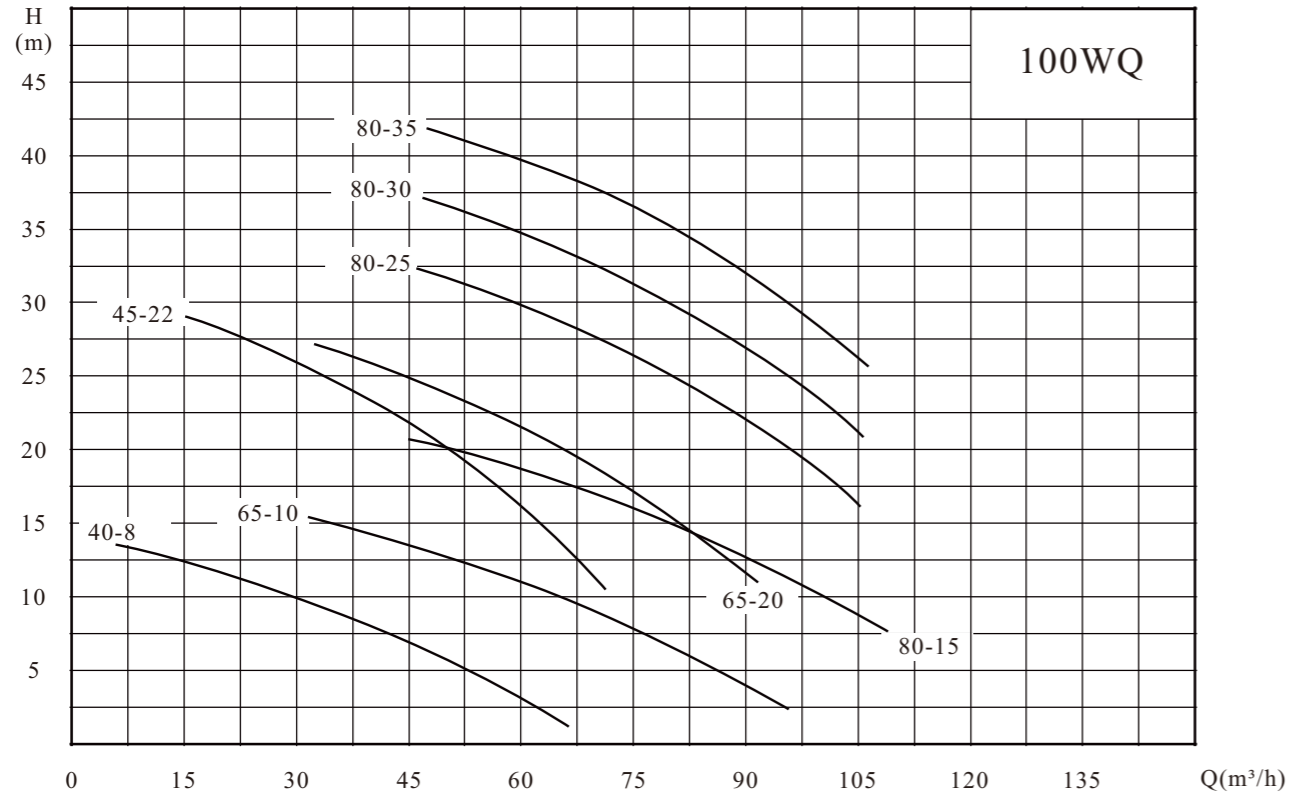

Curve

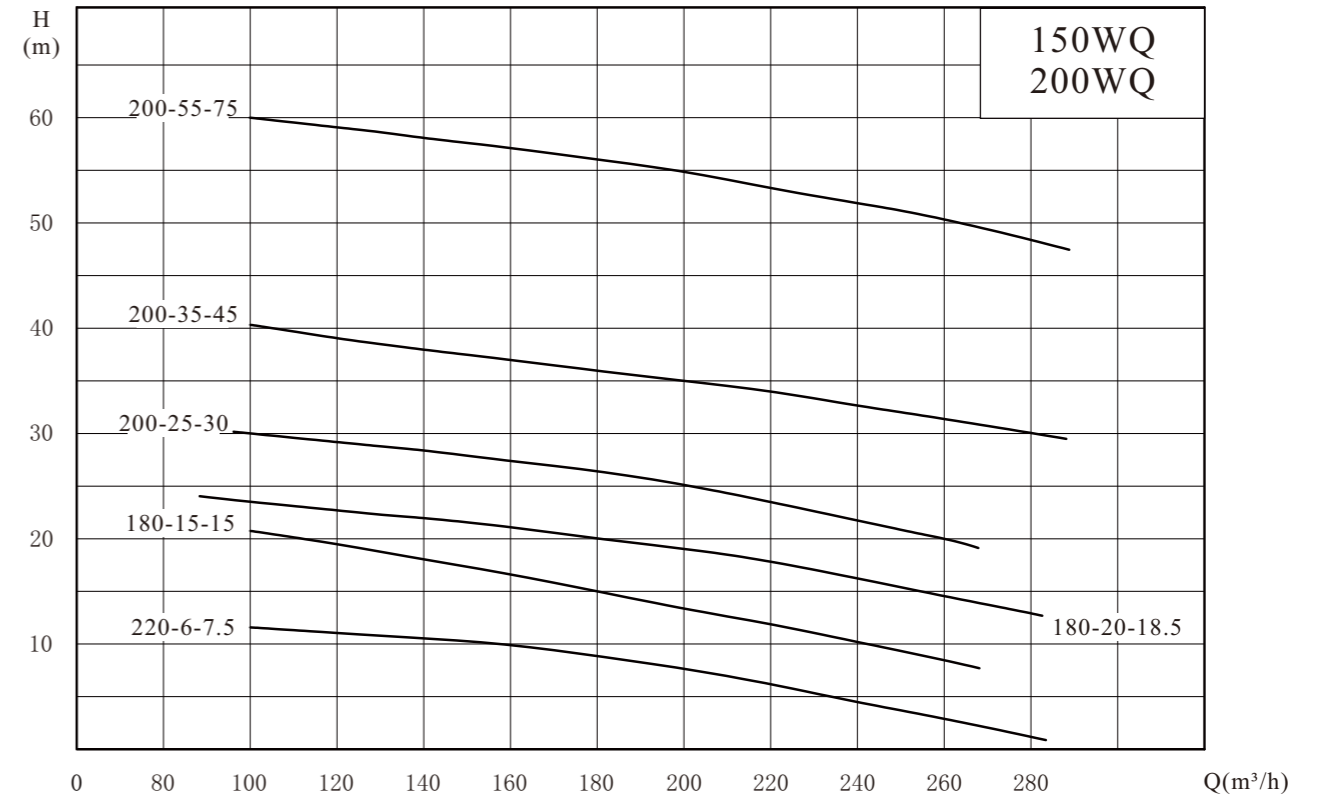
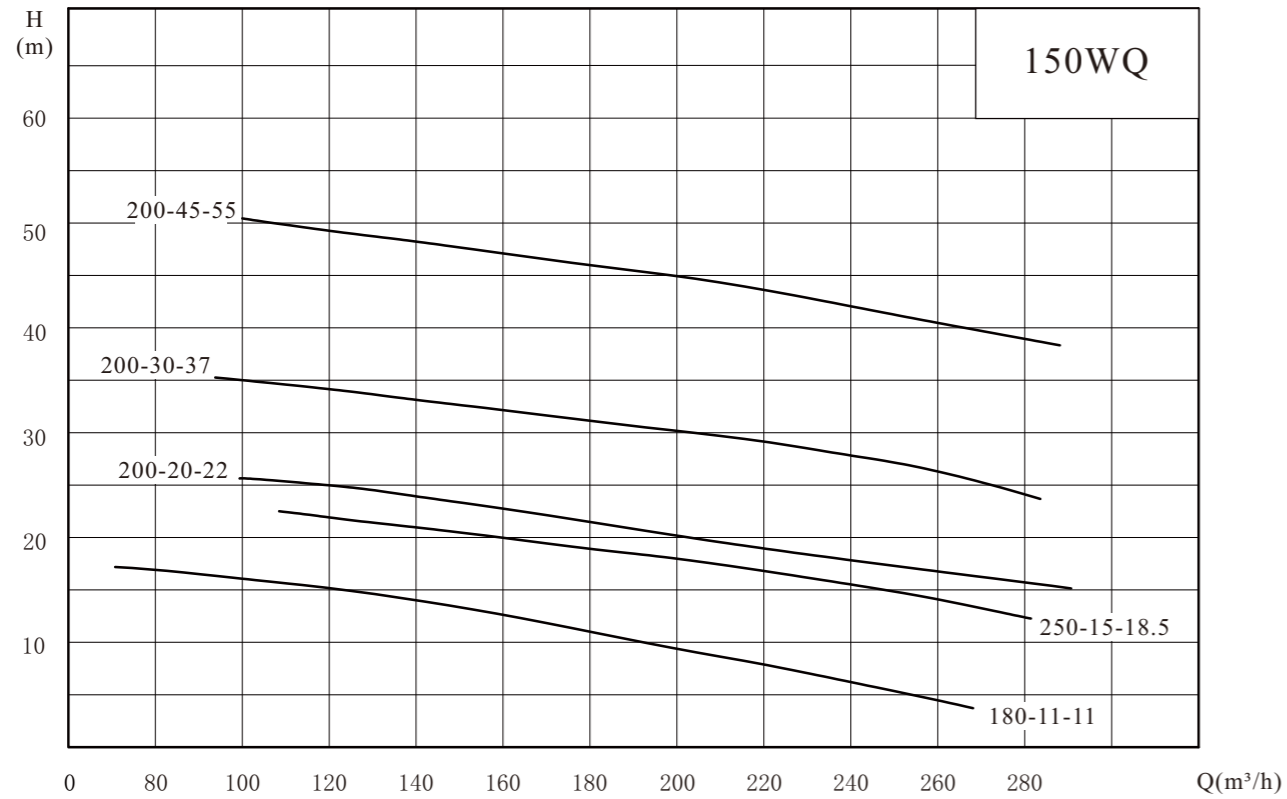
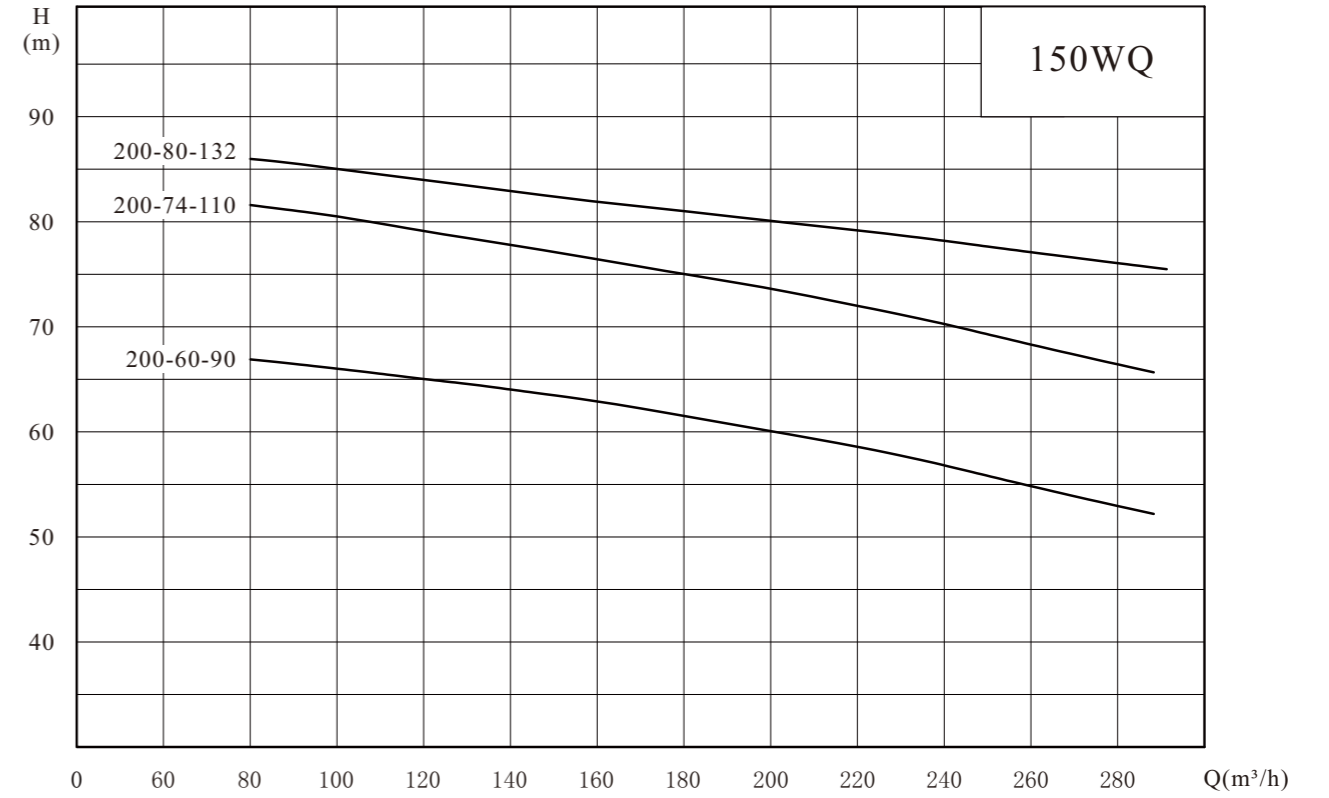

Curve

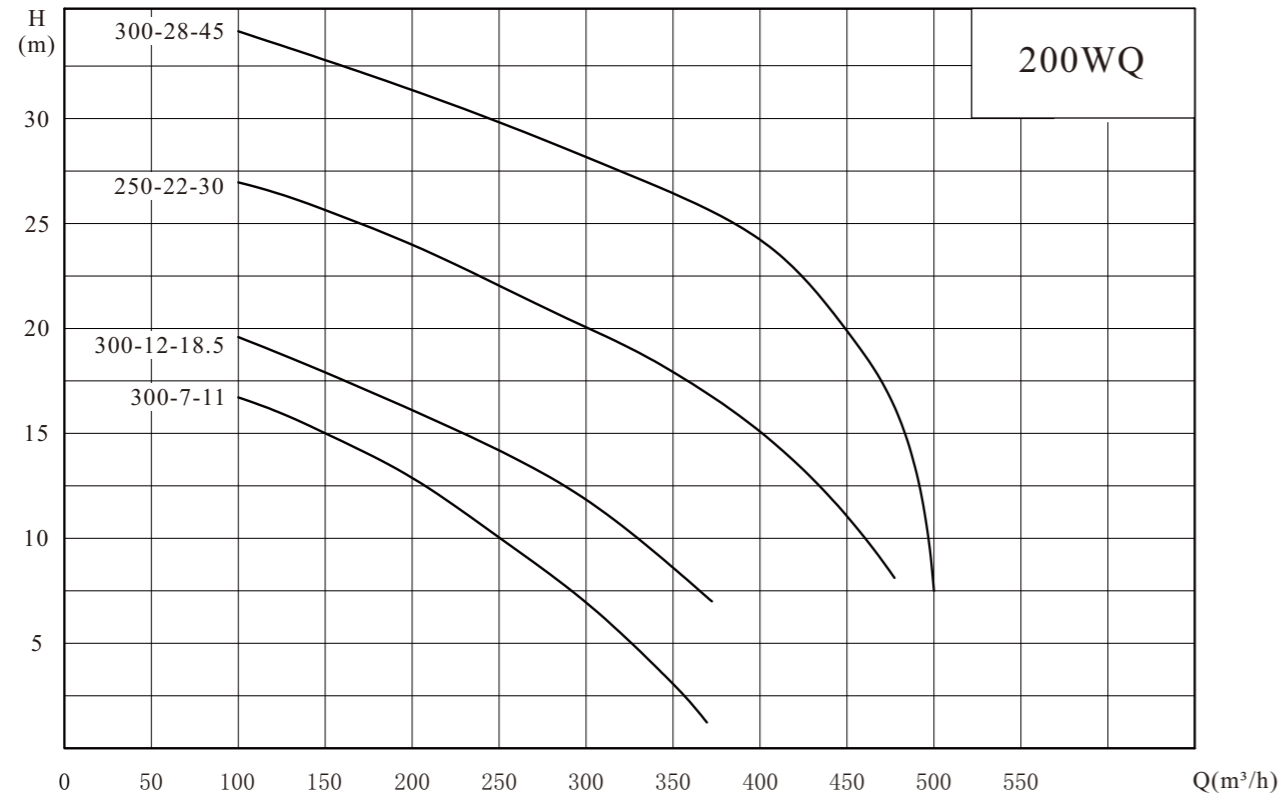

Curve

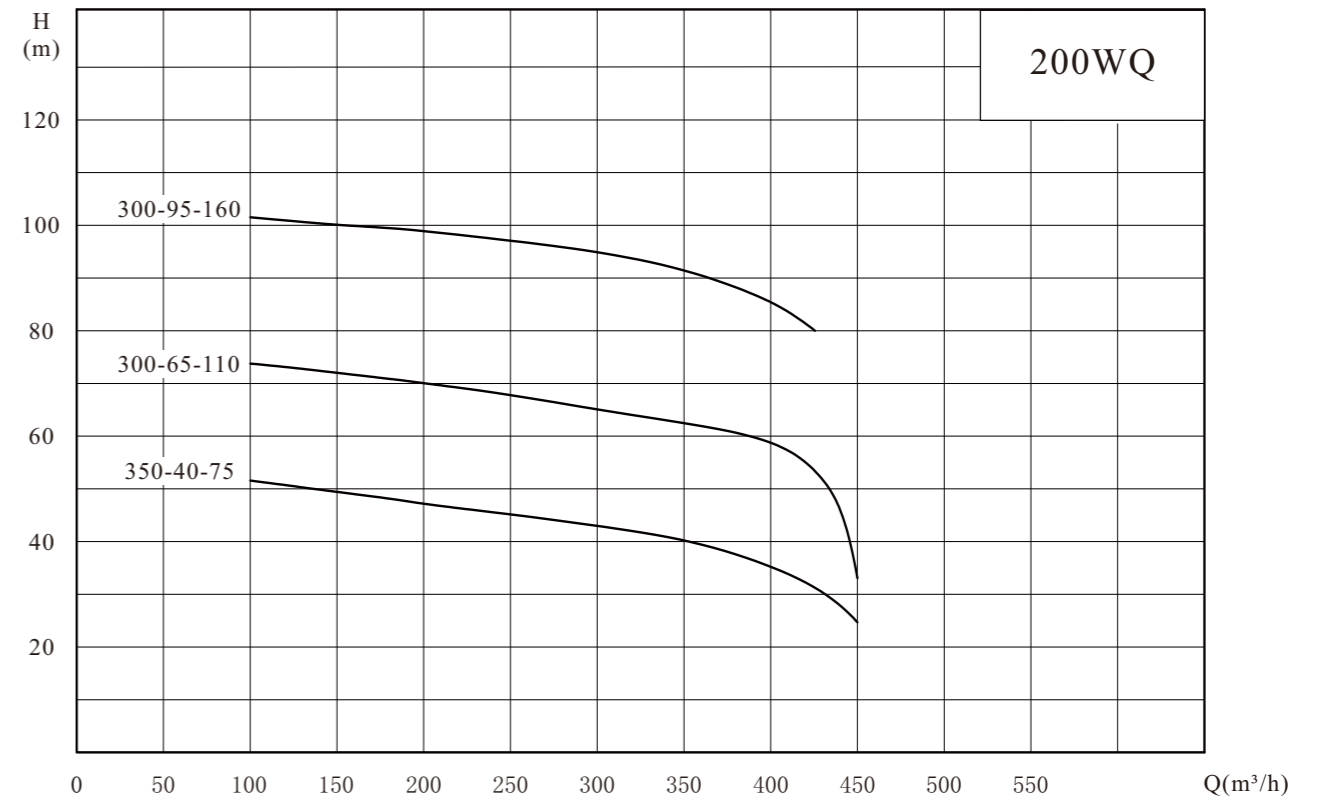
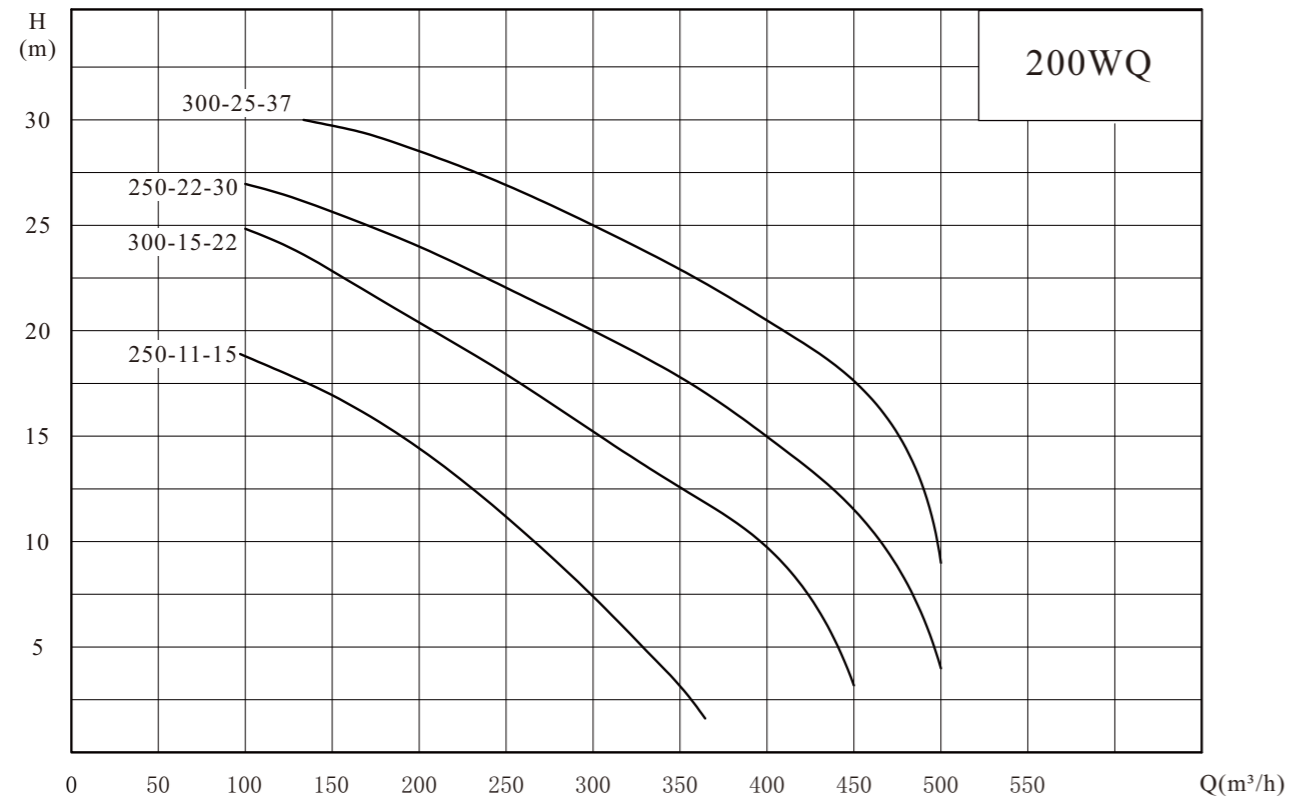
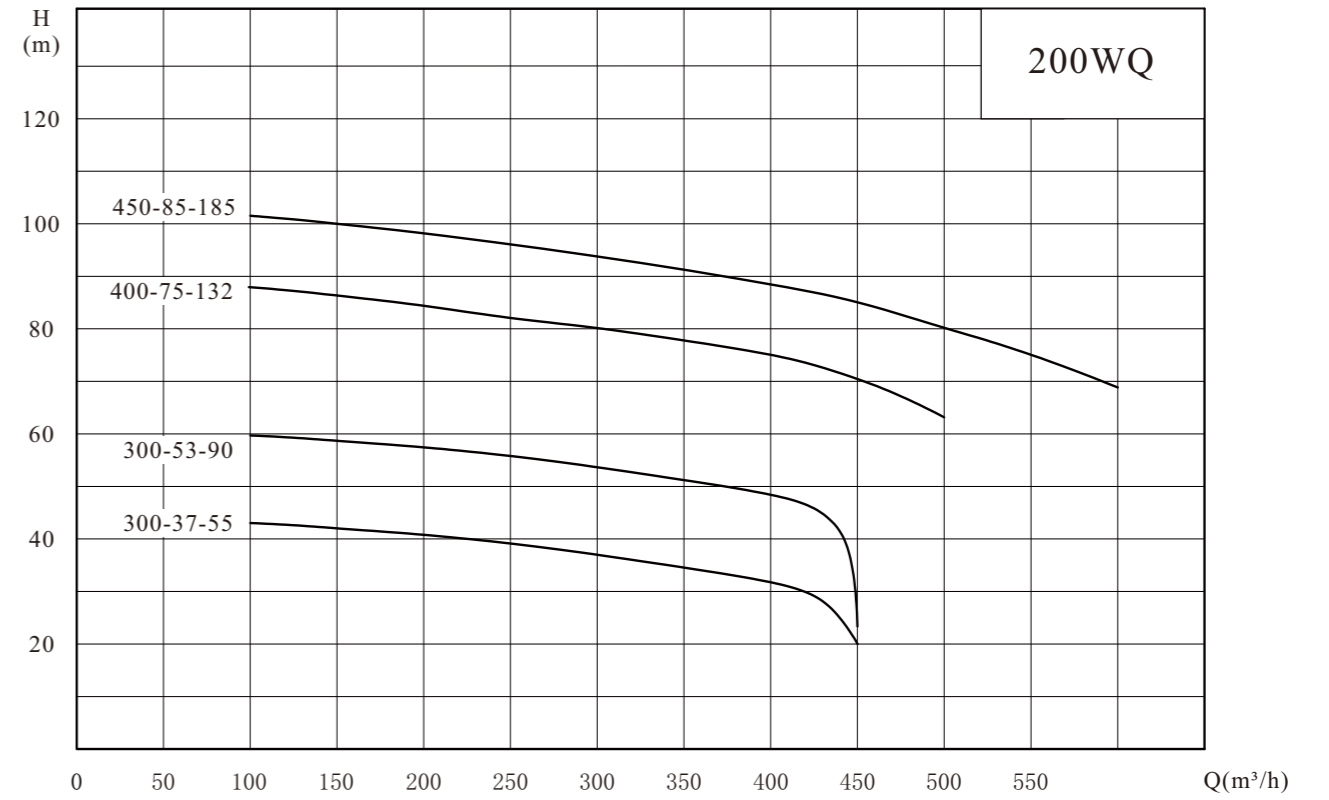

Curve

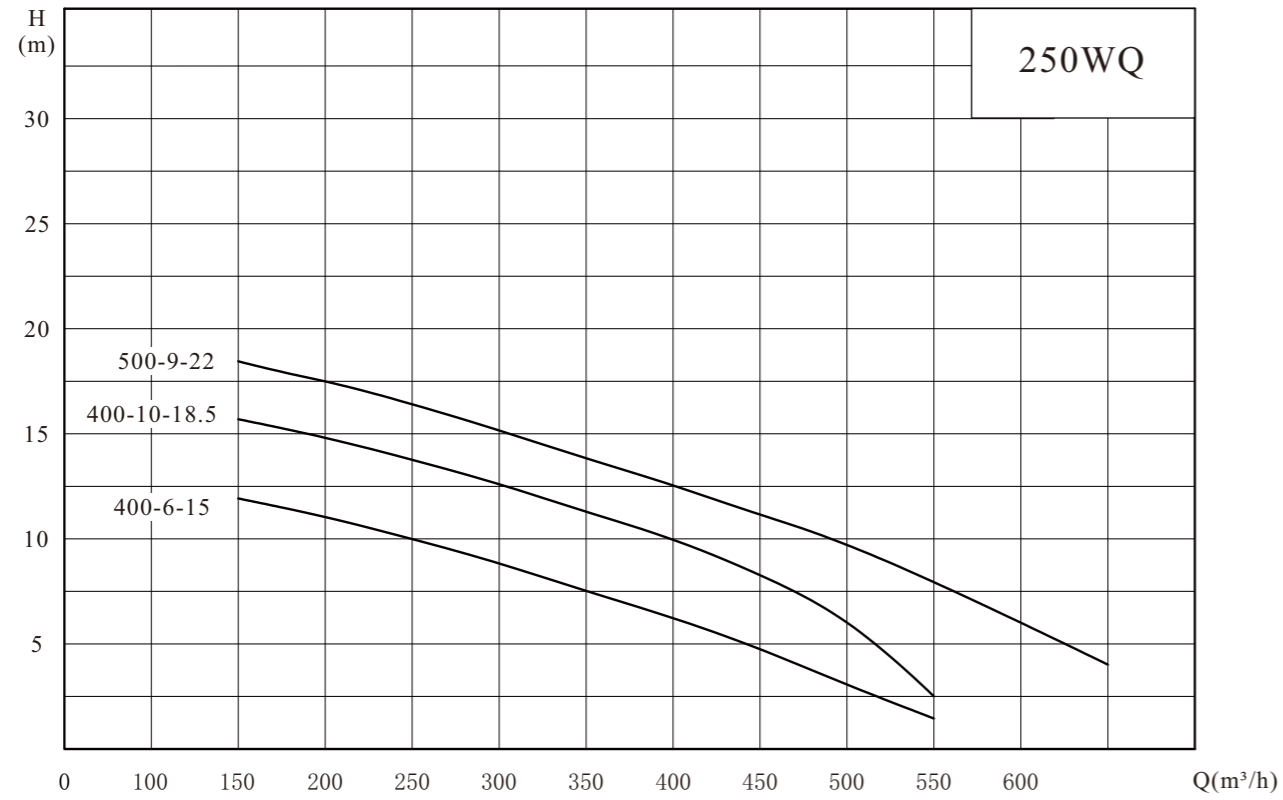

Curve

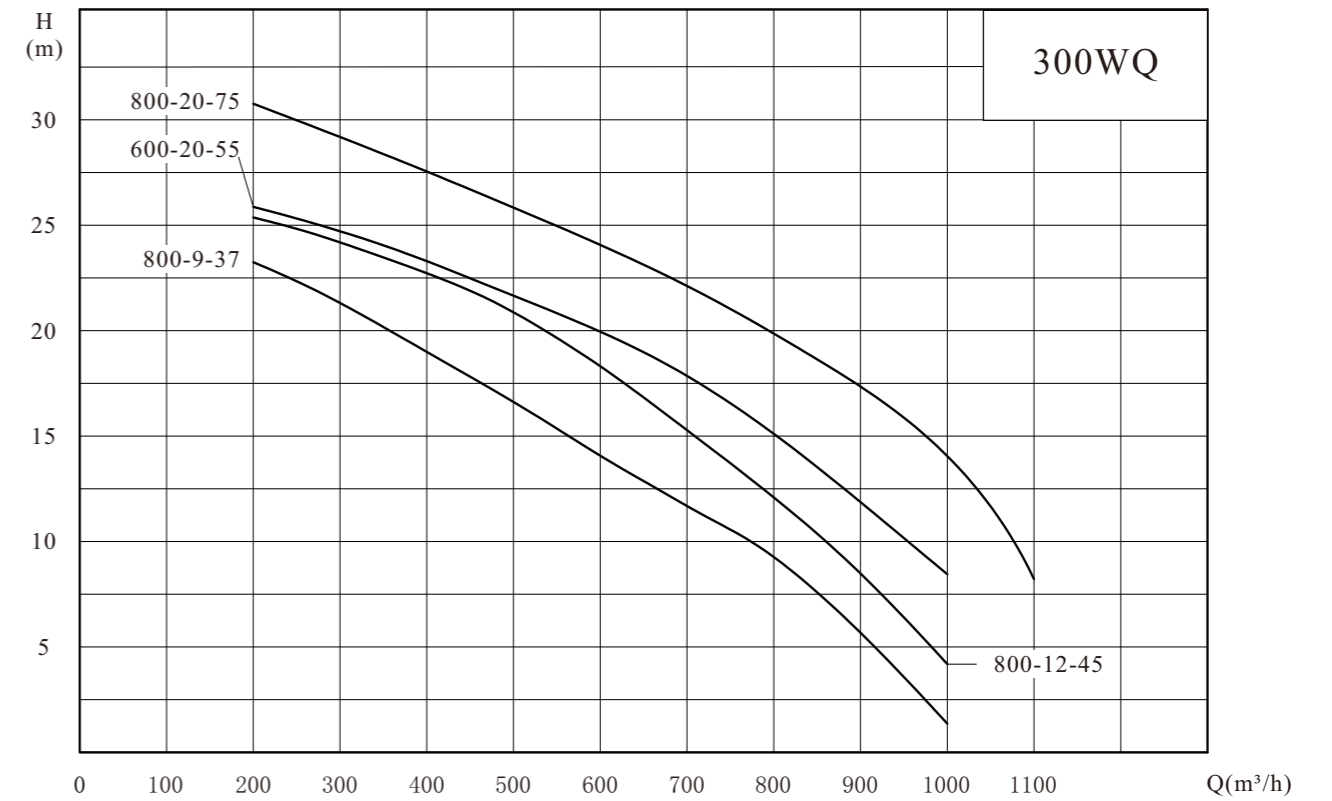
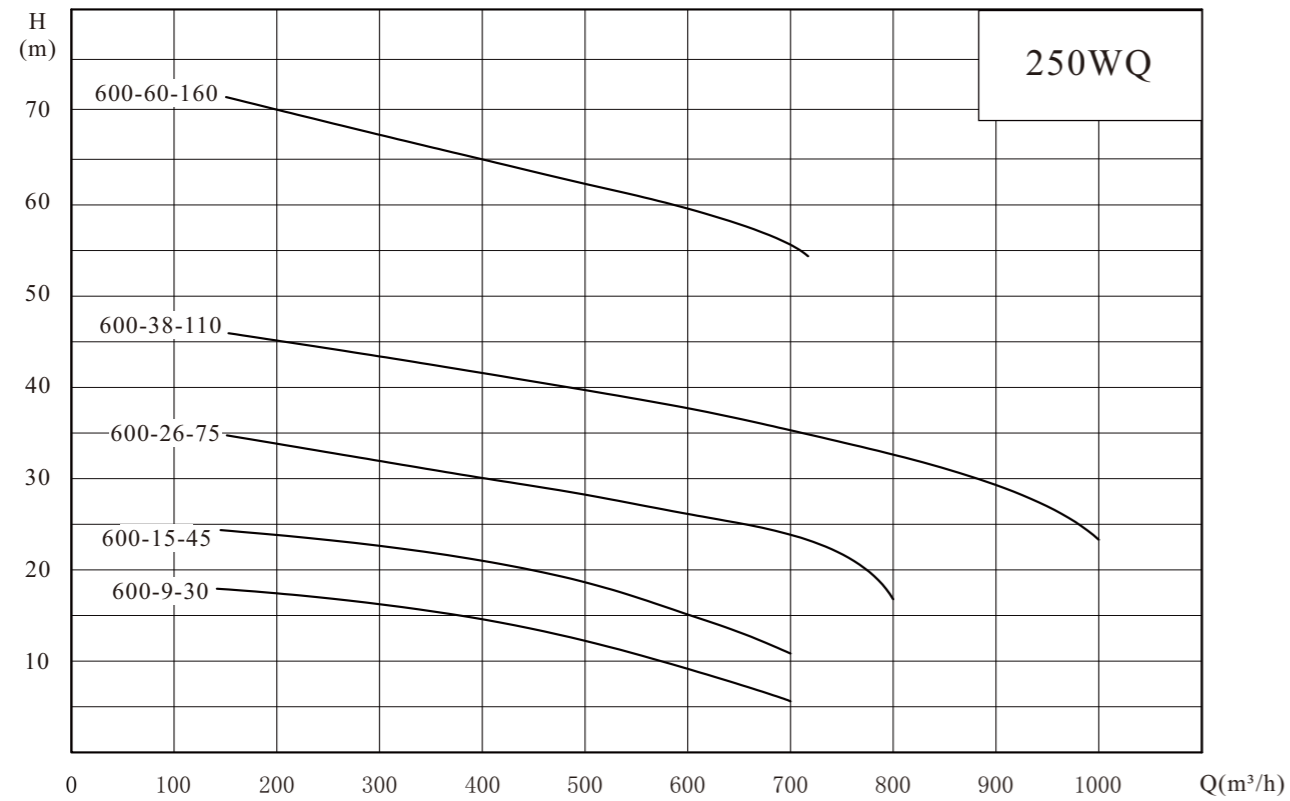
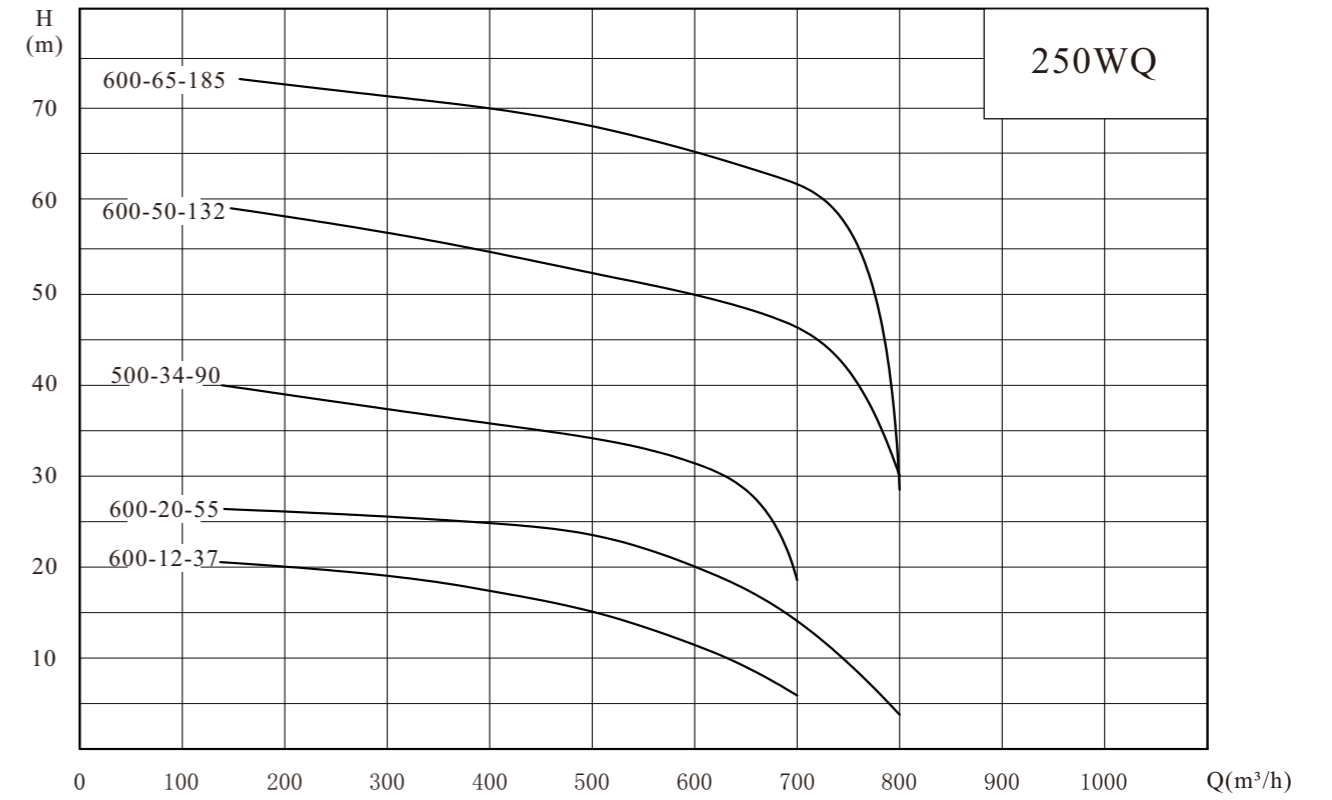

Curve

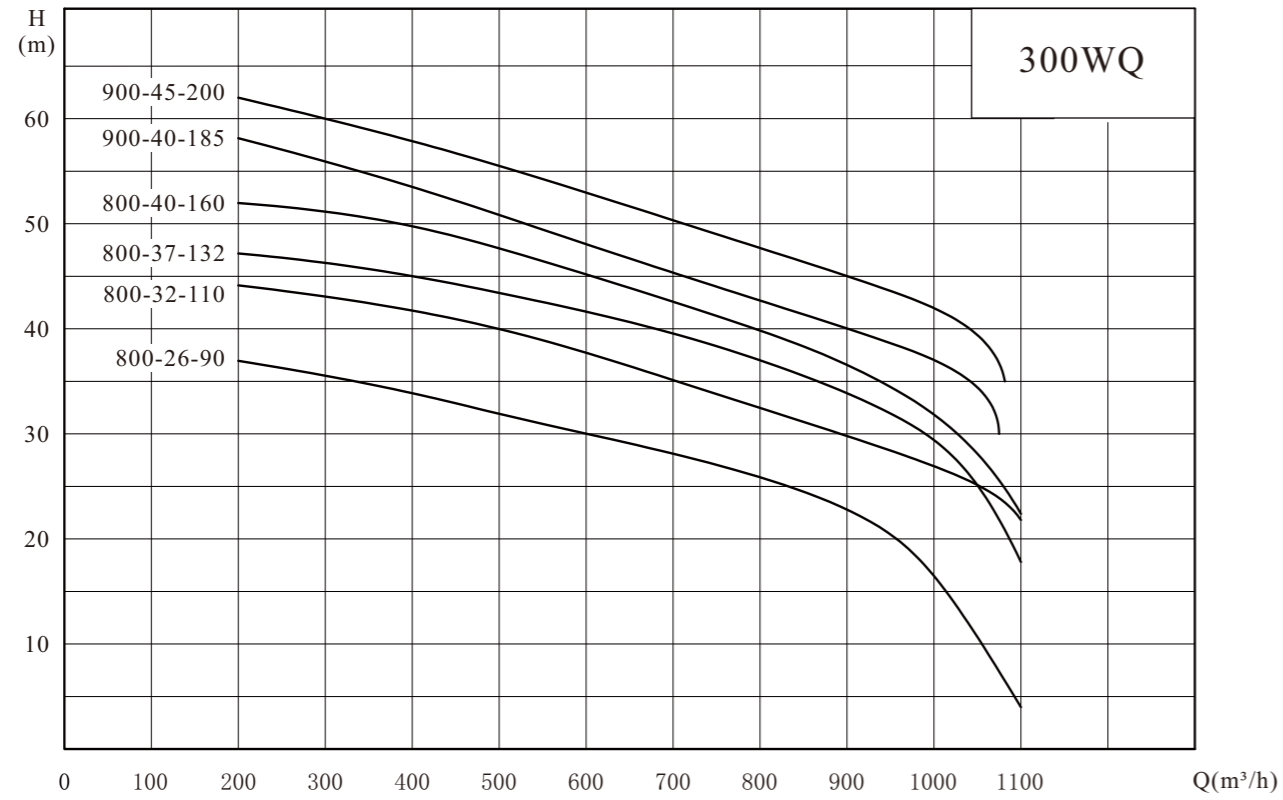

Curve

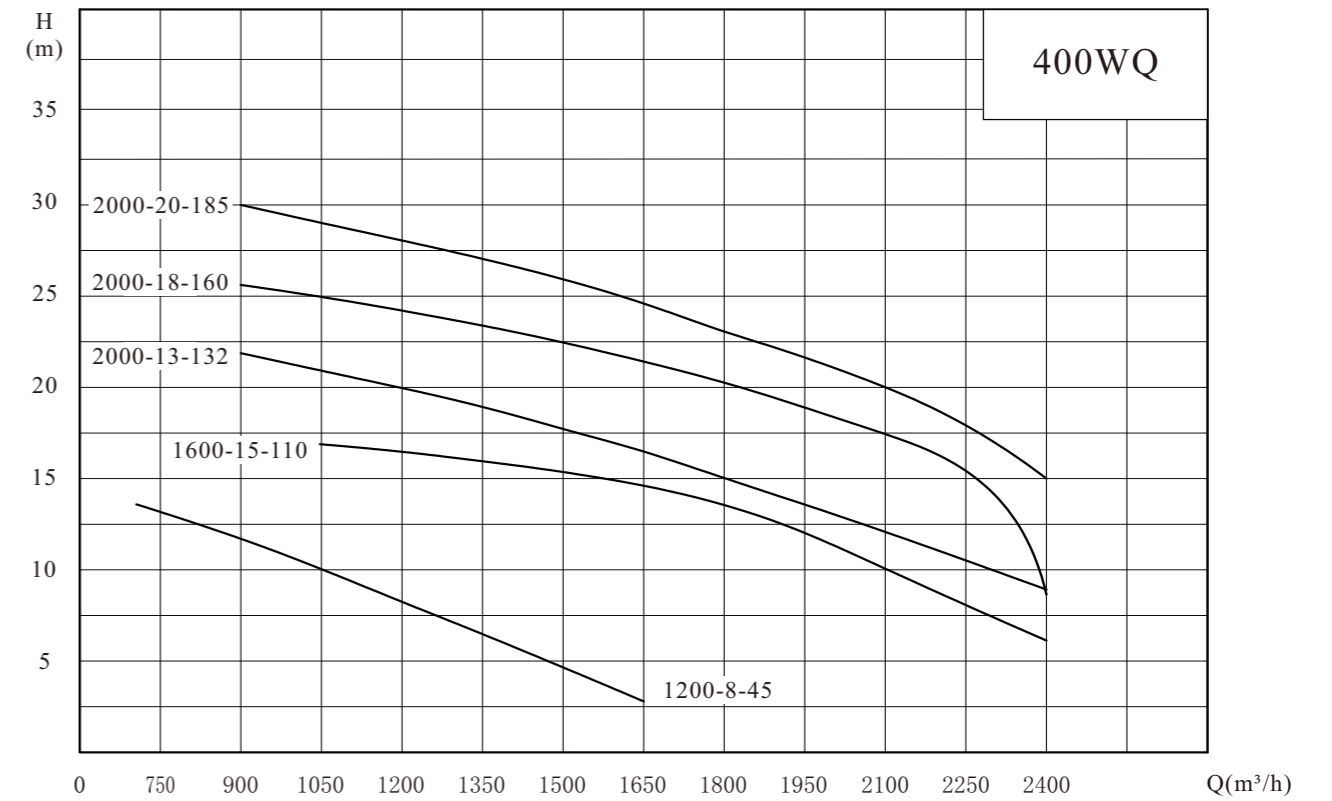
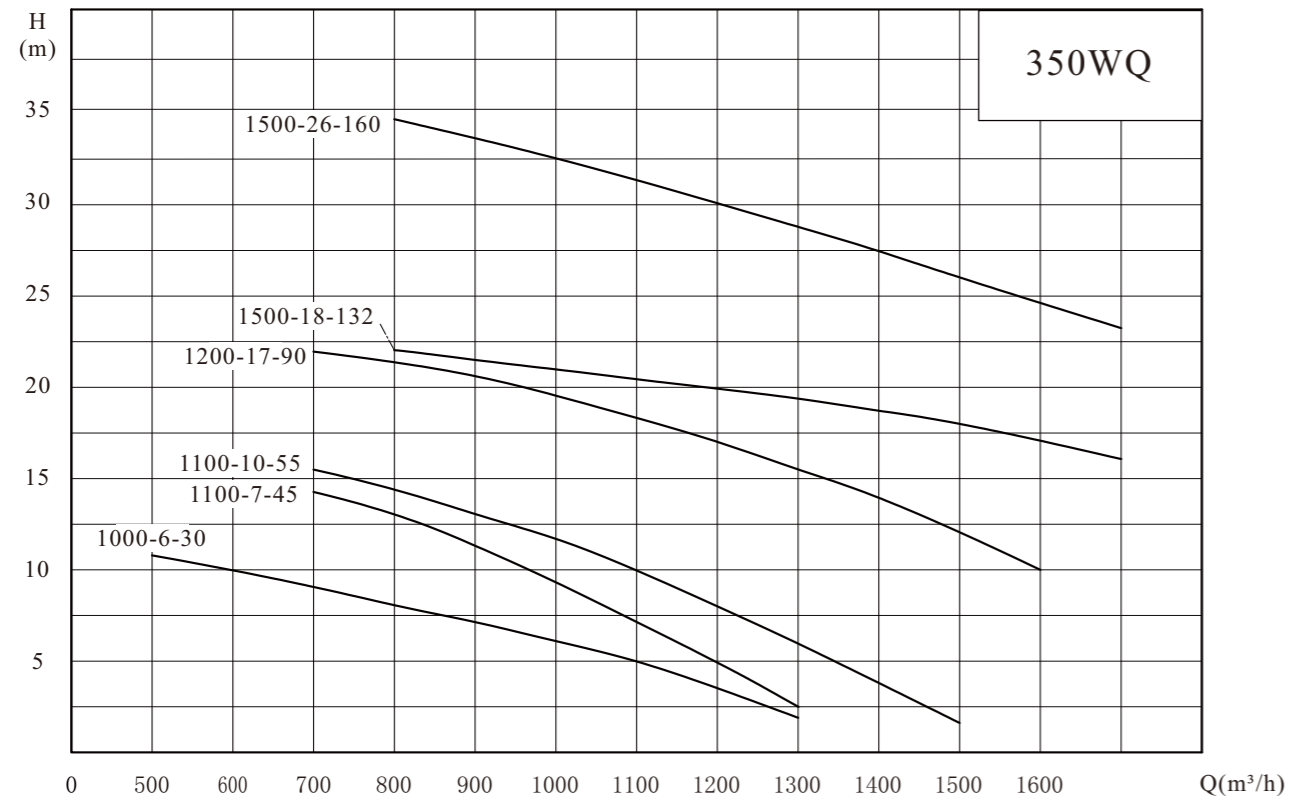
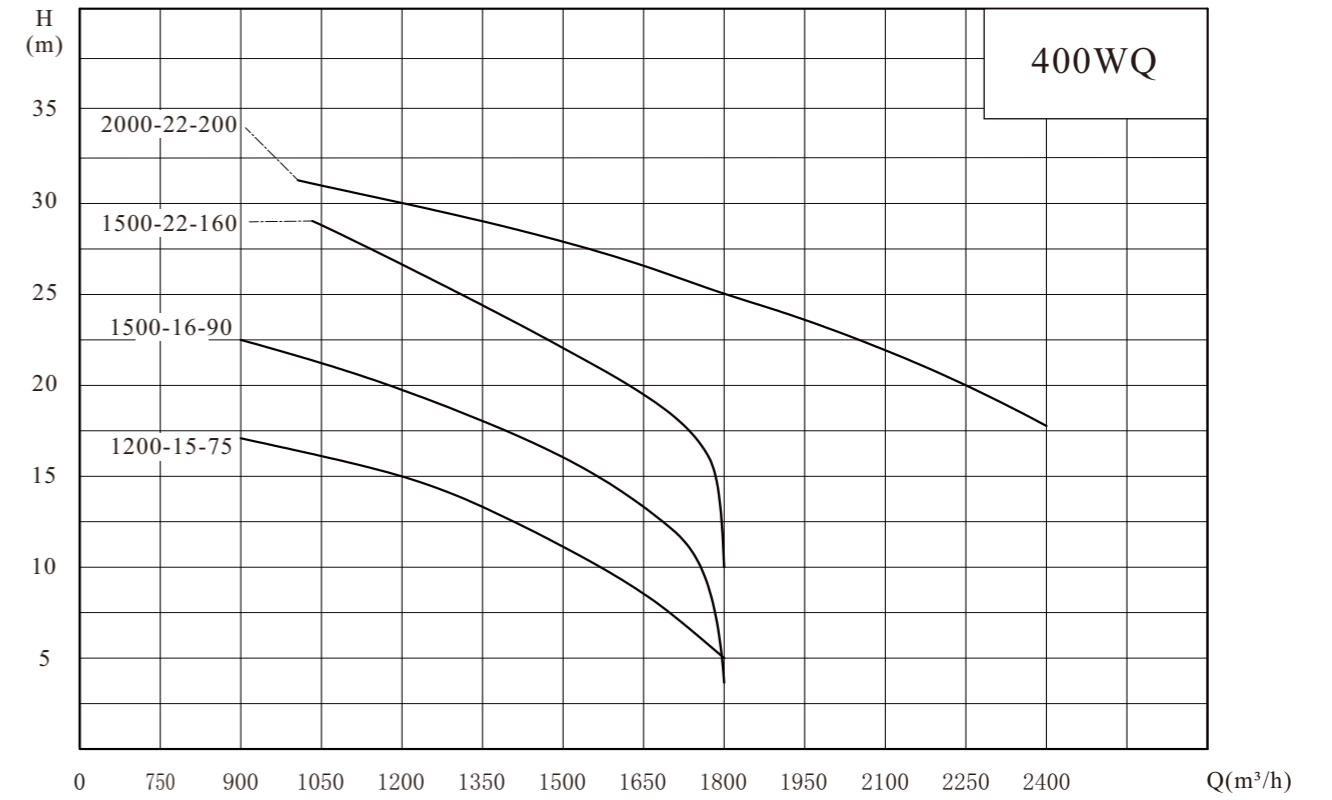

Curve

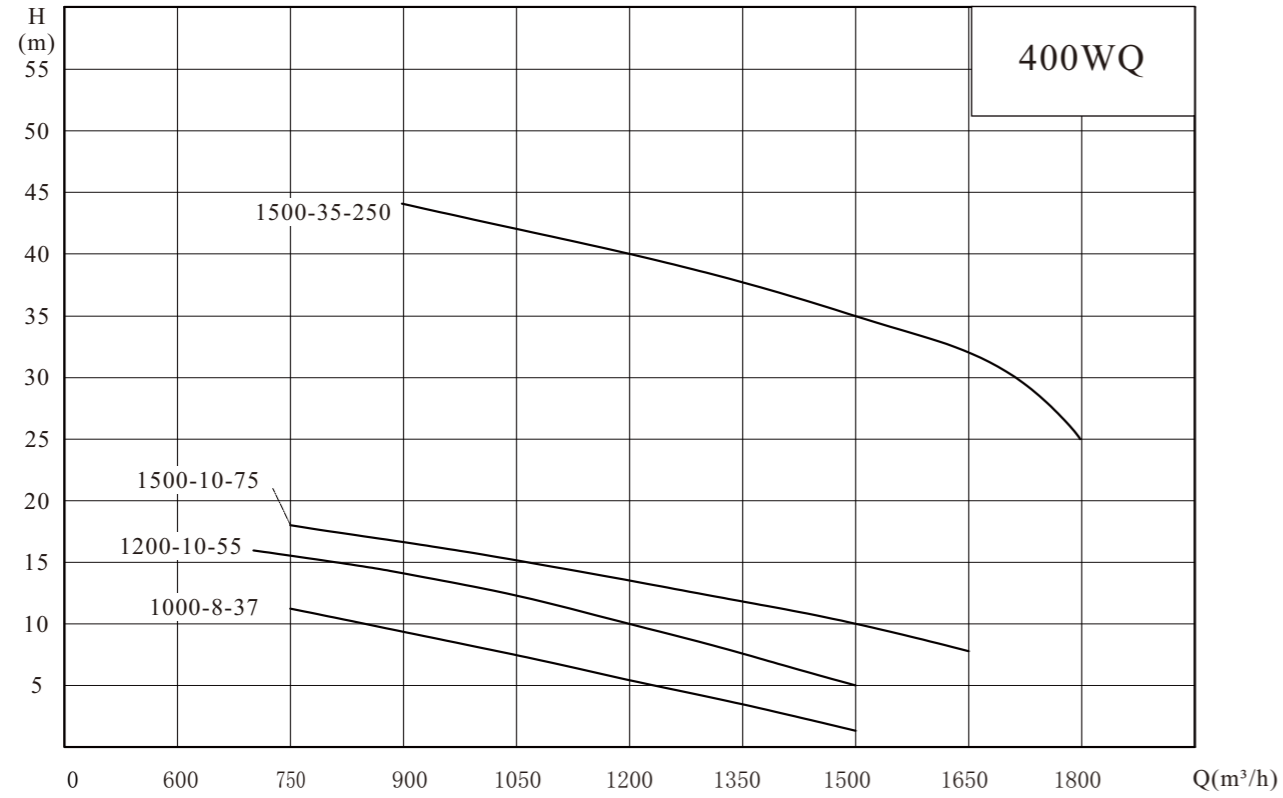

Curve

